







KM-18

Assemble Instructions

Hardware Identification

 A M6*10x12PCS	 B M6x1PC
 C x8PCS	 D x1PC

Part Identification

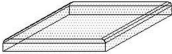
1 x2PCS 	2 x1PC 
3 x2PCS 	4 x1PC 

1

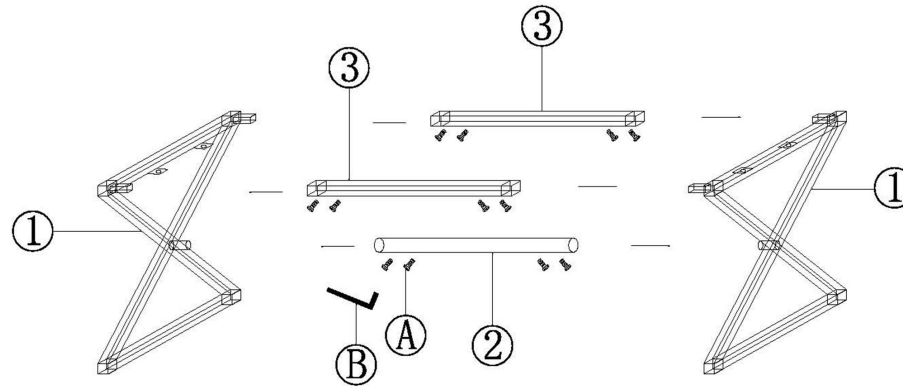

2

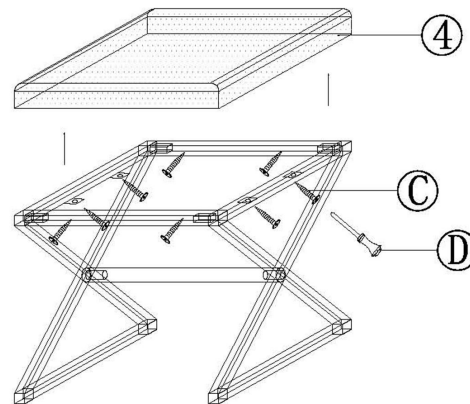

3

