

ASSEMBLY INSTRUCTION

ASSEMBLY PROGRAM

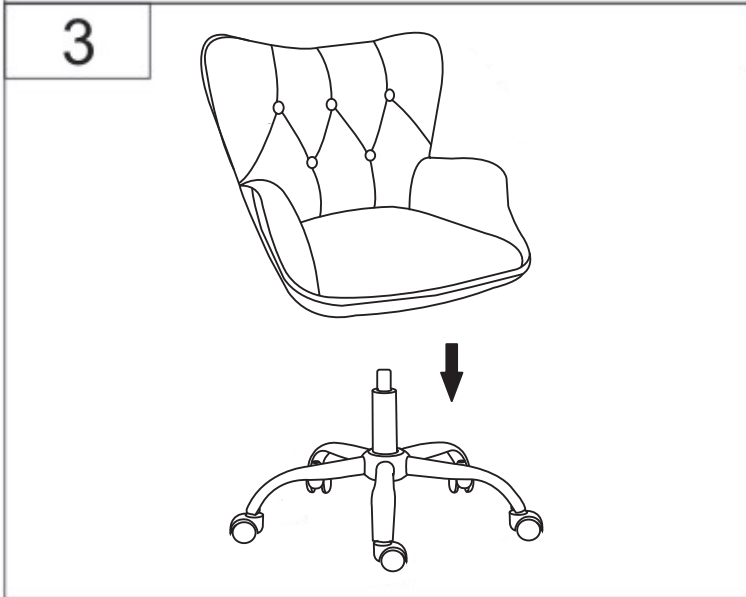
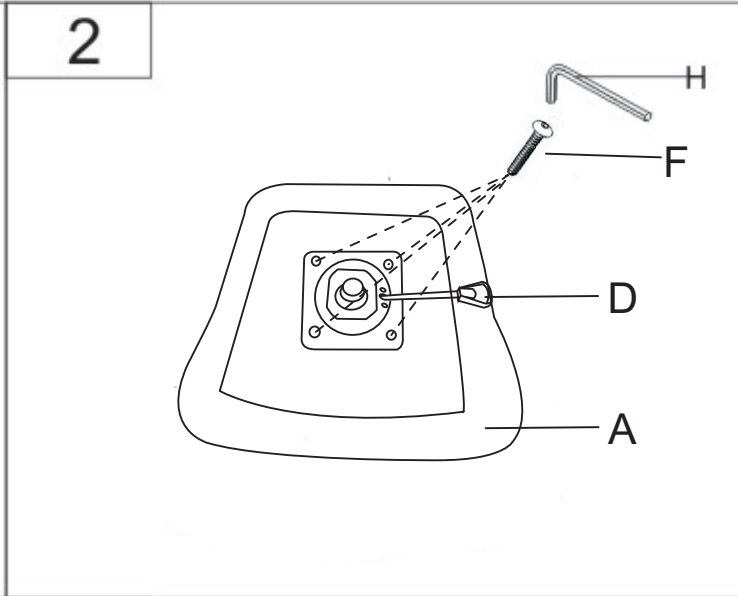
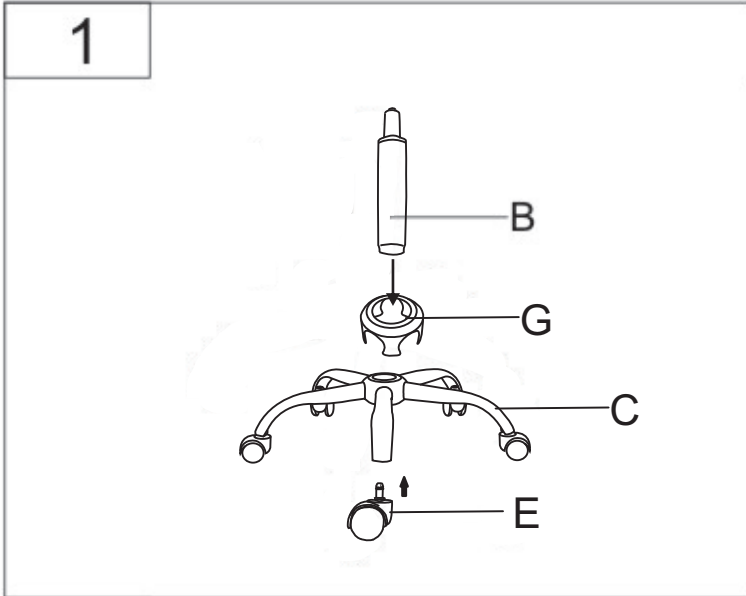

PARTSxQTY

<p>Ax1</p>	<p>Ex5</p>
<p>Bx1</p>	<p>Fx4</p> <p>M6x22</p>
<p>Cx1</p>	<p>Gx1</p>
<p>Dx1</p>	<p>Hx1</p>