

CARE AND MAINTENANCE

















Wipe clean with a soft, dry cloth. Test the cleaning method on a hidden area before using them over the entire area.

NOTICE

- * Please make sure that you have all parts indicated before you begin assembly of this item.
- * This item should be assembled on a soft surface to prevent scratching the finished product during assembly.
- * This item may require periodic assembly.
- * Do not tighten bolts until completely assembled.

Product Dimensions: 30"W*33-1/2"D*34-1/4"H

Part List and Hardware List

PIECE	DESCRIPTION	PICTURE	QUANTITY
A	Side frame (Left)		1x
B	Side frame (Right)		1x
C	Bottom frame		1x
D	Connecting bar		1x
E	Back cushion		1x
F	Seat cushion		1x
H1	Allen Bolt	 1/4"x5/8"	6x
H2	Allen Bolt	 1/4"x1"	6x
H3	Flat Washer	 $\phi 13*1.0*\phi 6.5$	16x
H4	Double-thread bolt	 5/16"x3"	3x
H5	Flat Washer	 $\phi 19\text{mm}$	3x
H6	Spring Washer	 5/16"	3x
H7	Nut	 5/16"	3x
H8	Allen Bolt	 1/4"*2"	4x
H9	Wrench	 M12	1x
H10	Allen Key	 M4	1x

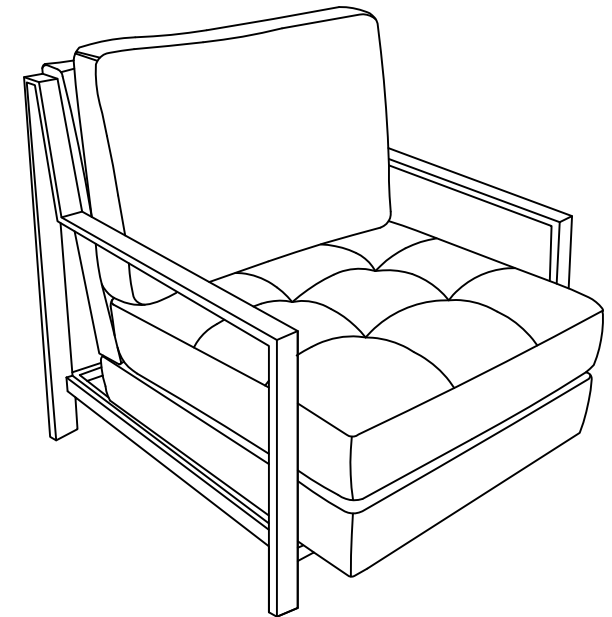

Weight capacity: 275lbs
WARNING: DO NOT STAND ON THE CHAIR

PREPARATION

Before beginning assembly of product, make sure all parts are present. Compare parts with package contents list and hardware contents list. If any part is missing or damaged, do not attempt to assemble the product.

Estimated Assembly Time: 15 minutes.

Tools Required for Assembly (included): Allen Key/Wrench

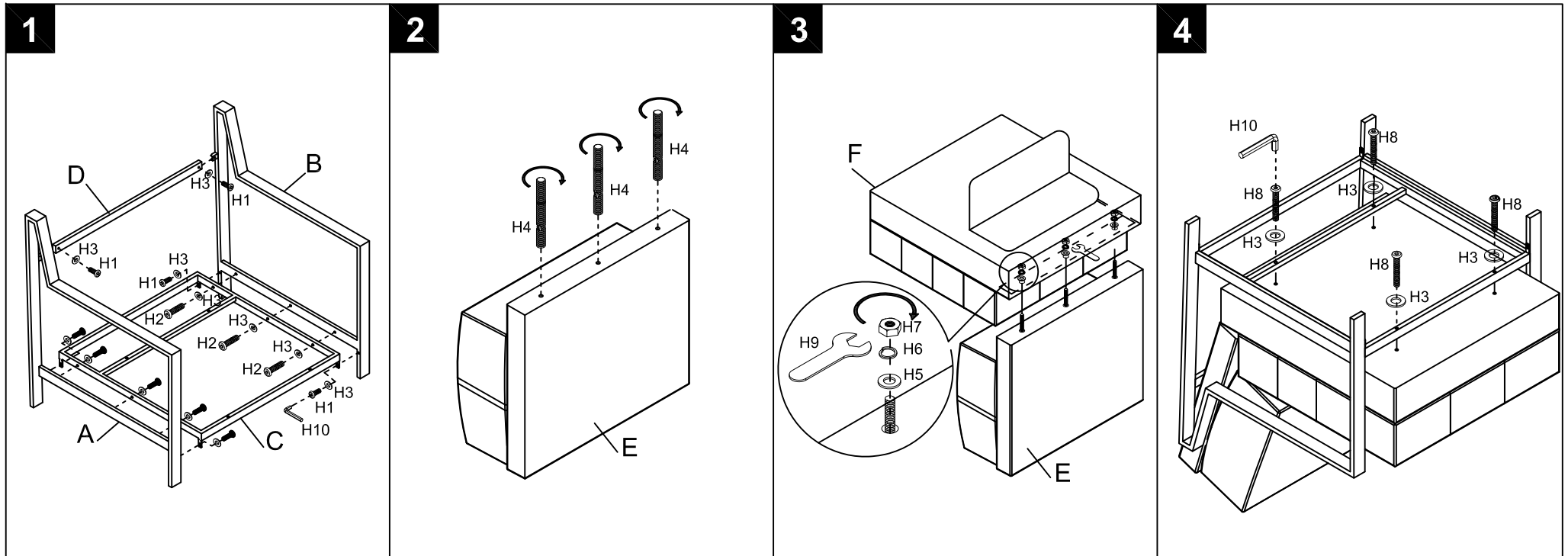

Step 1

Attached the connecting bar (D) to the 2 side frames (Left) "A" and (Right) "B", use Allen key (H10) to lock with 2 flat washer (H3) and 2 Allen bolt (H1). Then place the bottom frame (C) to the assembled side frame together, use Allen key (H10) to lock with 10 flat washer (H3) and 4 Allen bolt (H1) & 6 Allen bolt (H2), as picture.

Step 2

Screwing the short side of double-thread bolt (H4) into the bottom side of back cushion (E).

Step 3

Unzip seat cushion (F) then place the "step 2" back cushion into the seat cushion (F), lock with 3 flat washers (H5), 3 spring washers (H6) and 3 nuts (H7) by using wrench (H9). Zip up seat cushion.

Step 4

Place the assembled back cushion / seat cushion "step 3" with assembled metal frame "step 1" together, use Allen key (H10) to lock with 4 flat washer (H3) and 4 Allen bolt (H8).