

# ASSEMBLY INSTRUCTION

## SKU# 97523

**Before beginning**

- Unpack all parts and hardware to ensure you have all needed components for assembly
- Read this guide cover before beginning assembly .
- Assemble this item on a soft surface such as carpet to protect finish.
- Proper assembly of this item requires 2 person & 20 minutes to assemble.

**CARE INSTRUCTIONS**

Wipe with a soft and dry cloth. To protect finish, avoid the use of chemicals and household cleaners. Any liquid in the table should be cleaned up immediately with a damp cloth.

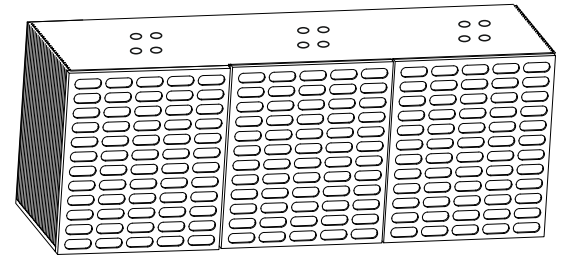

**BOX**

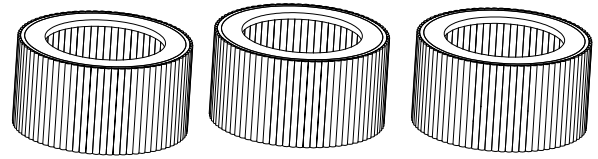





**LEG**

**HOW TO ASSEMBLE**

STEP-1 Place the sideboard upside on rug and match marking A with A and B with B and C with C respectively.

STEP-2 Insert allen bolt E with spring washer G and flat washer F then tighten with allen key D.

STEP-3 Turn the sideboard upside down, sideboard ready to use.

No.	Sketch	Description.	Size (IN)	Qty.	Ext.
D		ALLEN KEY	0.19"	1	0
E		ALLEN BOLT	0.31X1.18"	12	1
F		WASHER	0.35X1 "	12	1
G		SPRING WASHER	0.35X0.5"	12	1
H		SCREWDRIVER		1	0

# STEP- 1

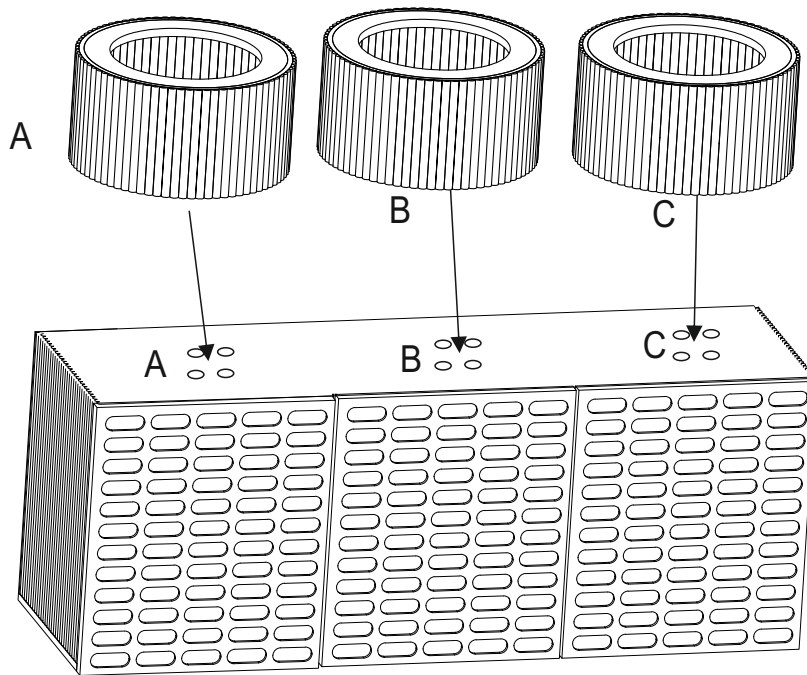

Tip for leveling of product:  
When the product rests on an uneven floor surface  
it will appear to be unbalanced. To aid in leveling, try  
adjusting the levelers on the bottom of each foot.

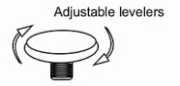

# STEP- 2

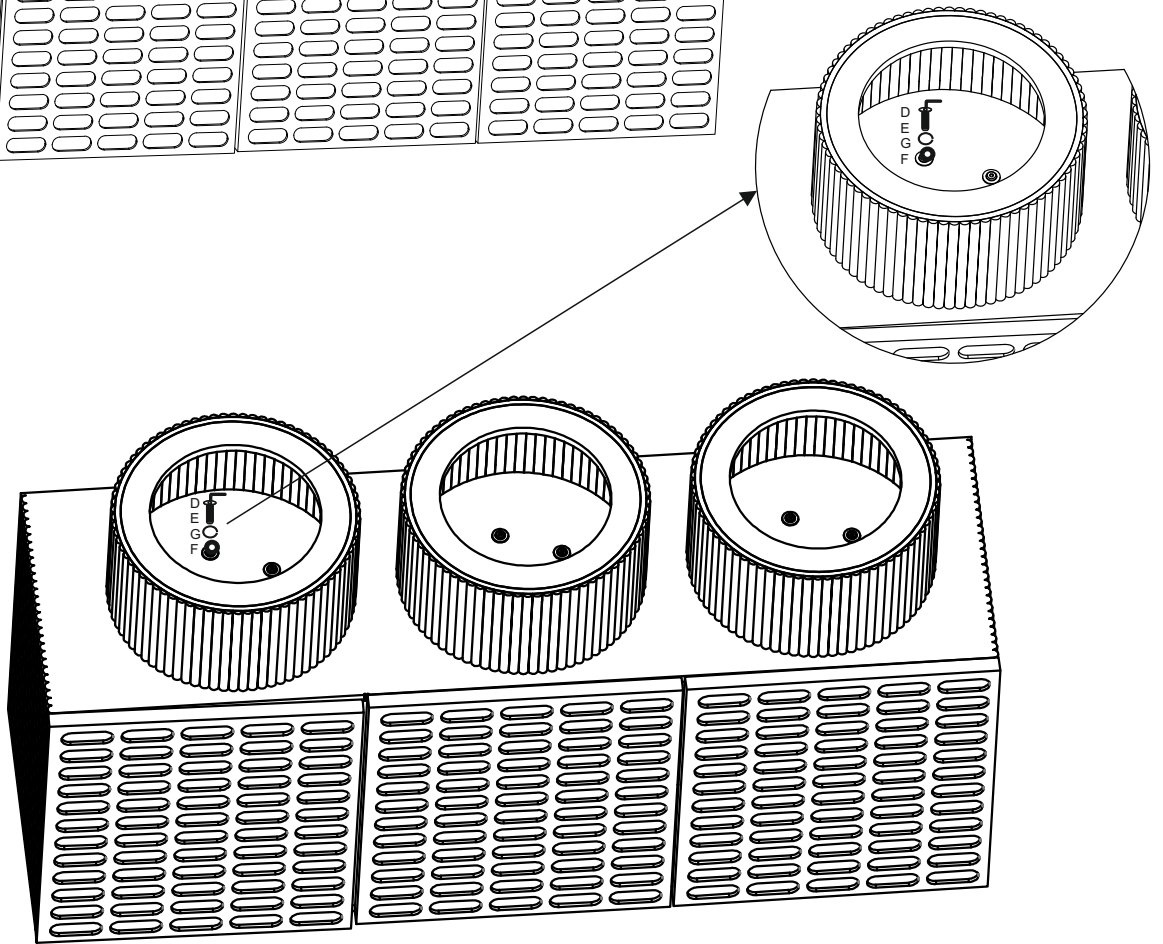

# STEP- 3

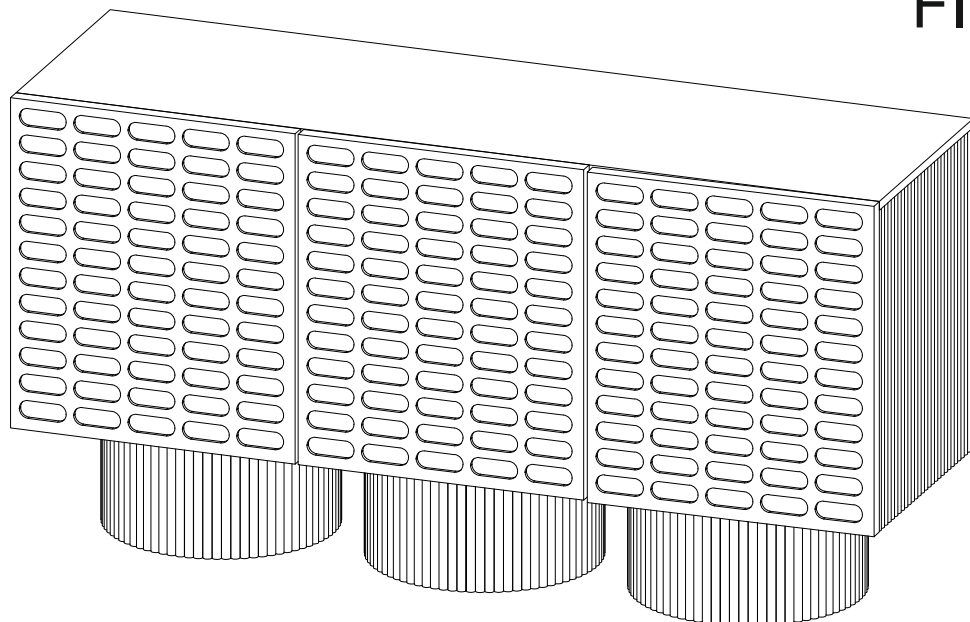

# FINAL