

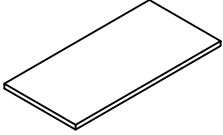



ASSEMBLY INSTRUCTIONS

HARDWARE			COMPONENT		
No	Description	Q'ty	No	Description	Q'ty
1	Bolt Ø6*20 	6Pcs	A		1Pc
2	Bolt Ø8*50 	4Pcs	B		2Pcs
3	Washer 	10Pcs	C		2Pcs
4	Allen Key 	1Pc			

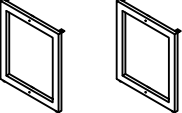

MADE IN VIETNAM

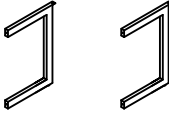
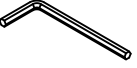
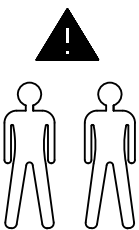
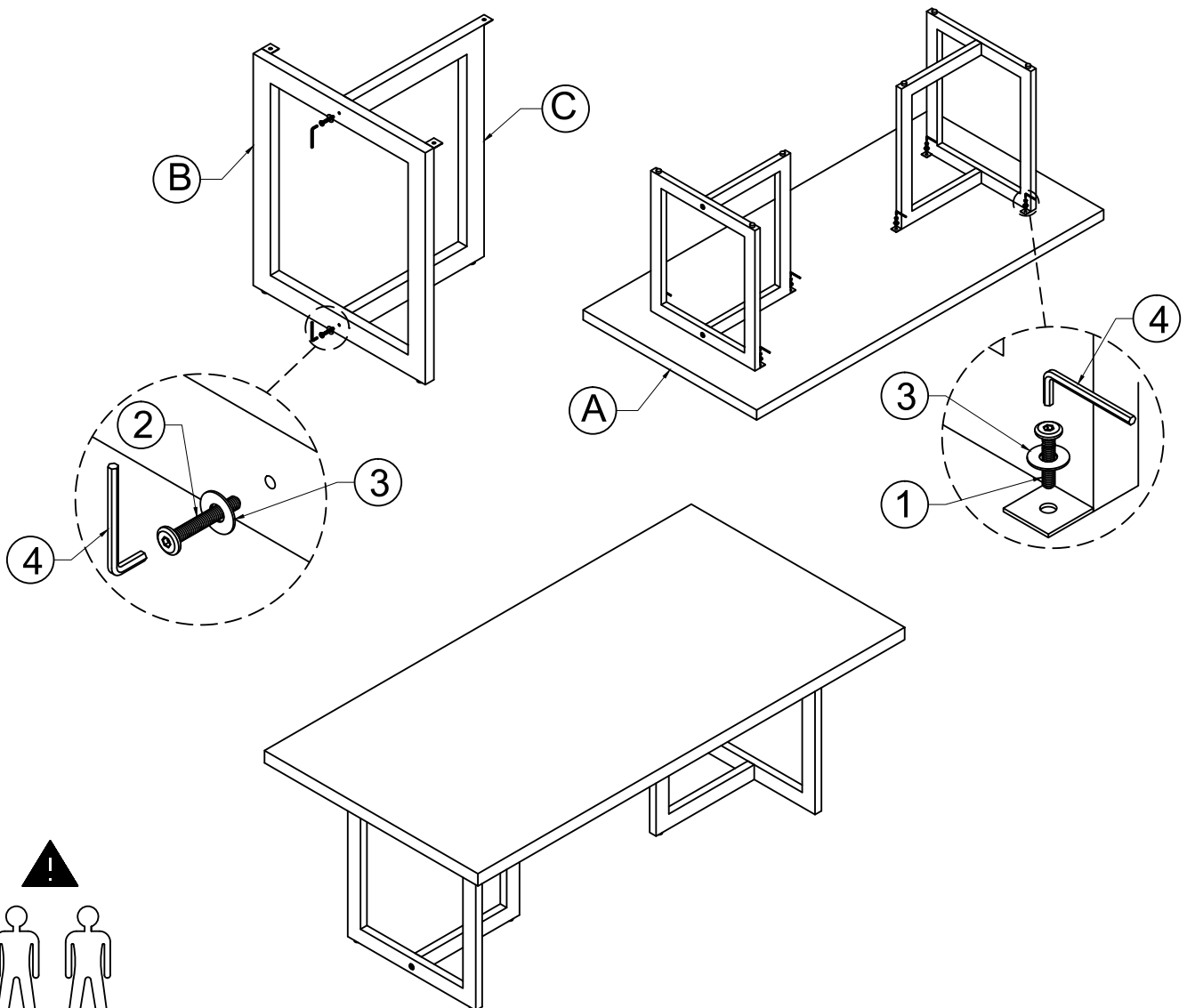
01/01