

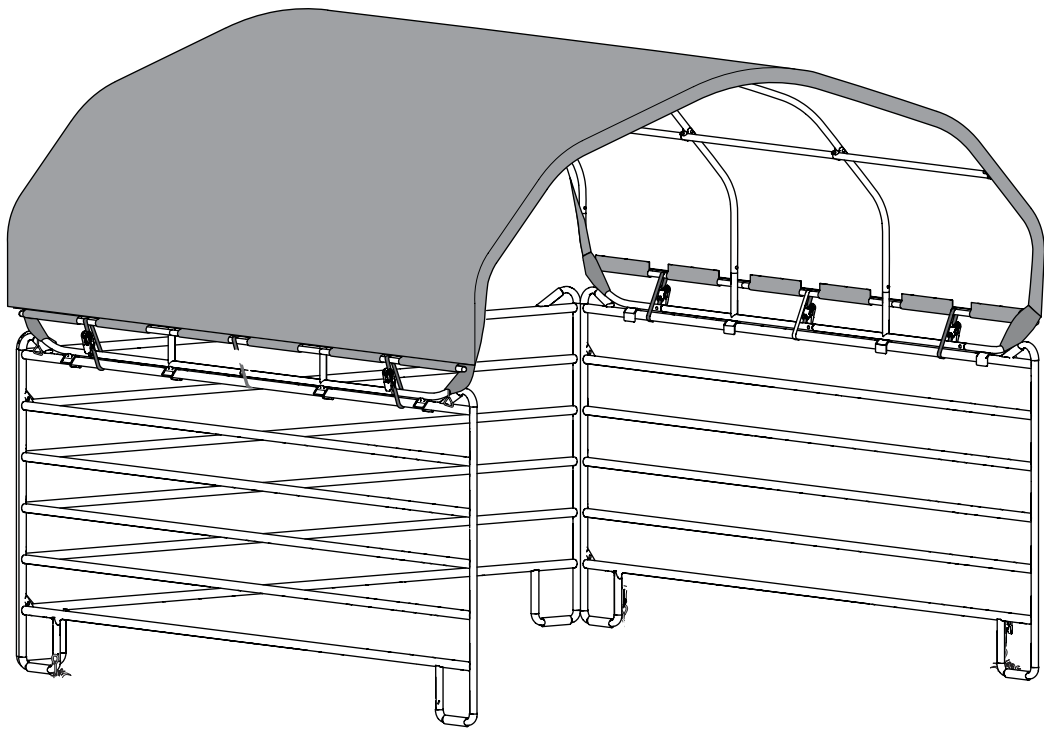

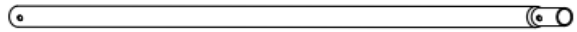

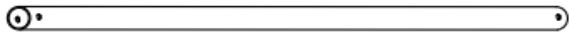







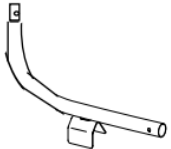
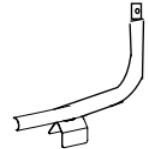
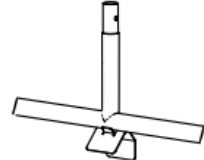

10x10TF

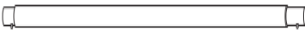

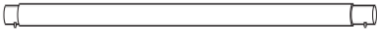
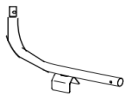
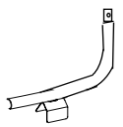
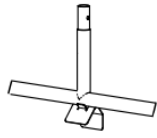
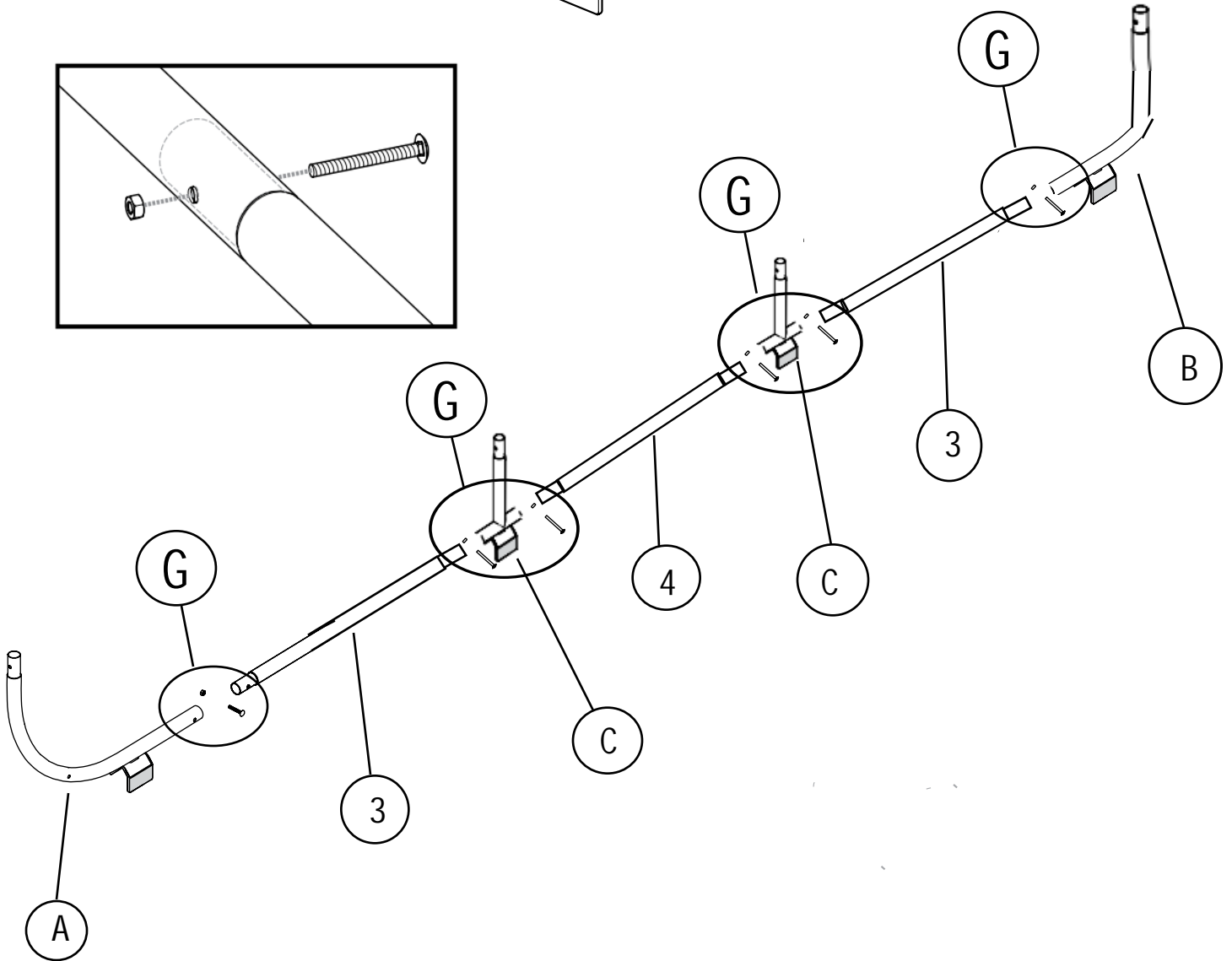
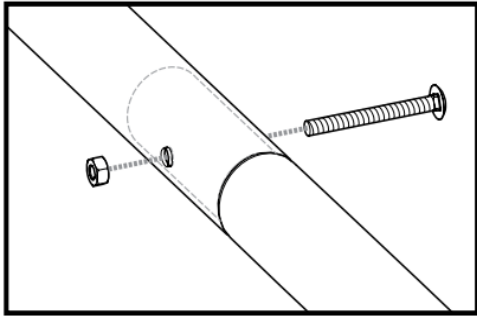
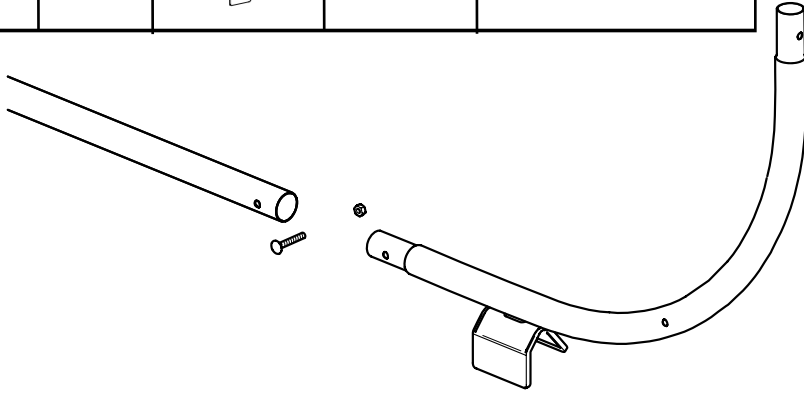
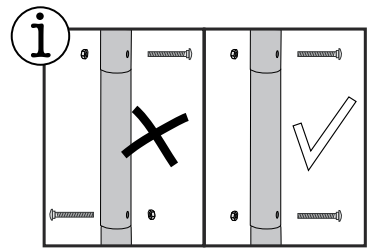
1	x5			
2	x5			
3	x4			
4	x2			
5	x4			
6	x8			
				
A x2	B x2	C x4	D x6	E x1
				
F x12	G x48			

3 x4		G x6	
4 x2			
A x1		B x1	
C x2			



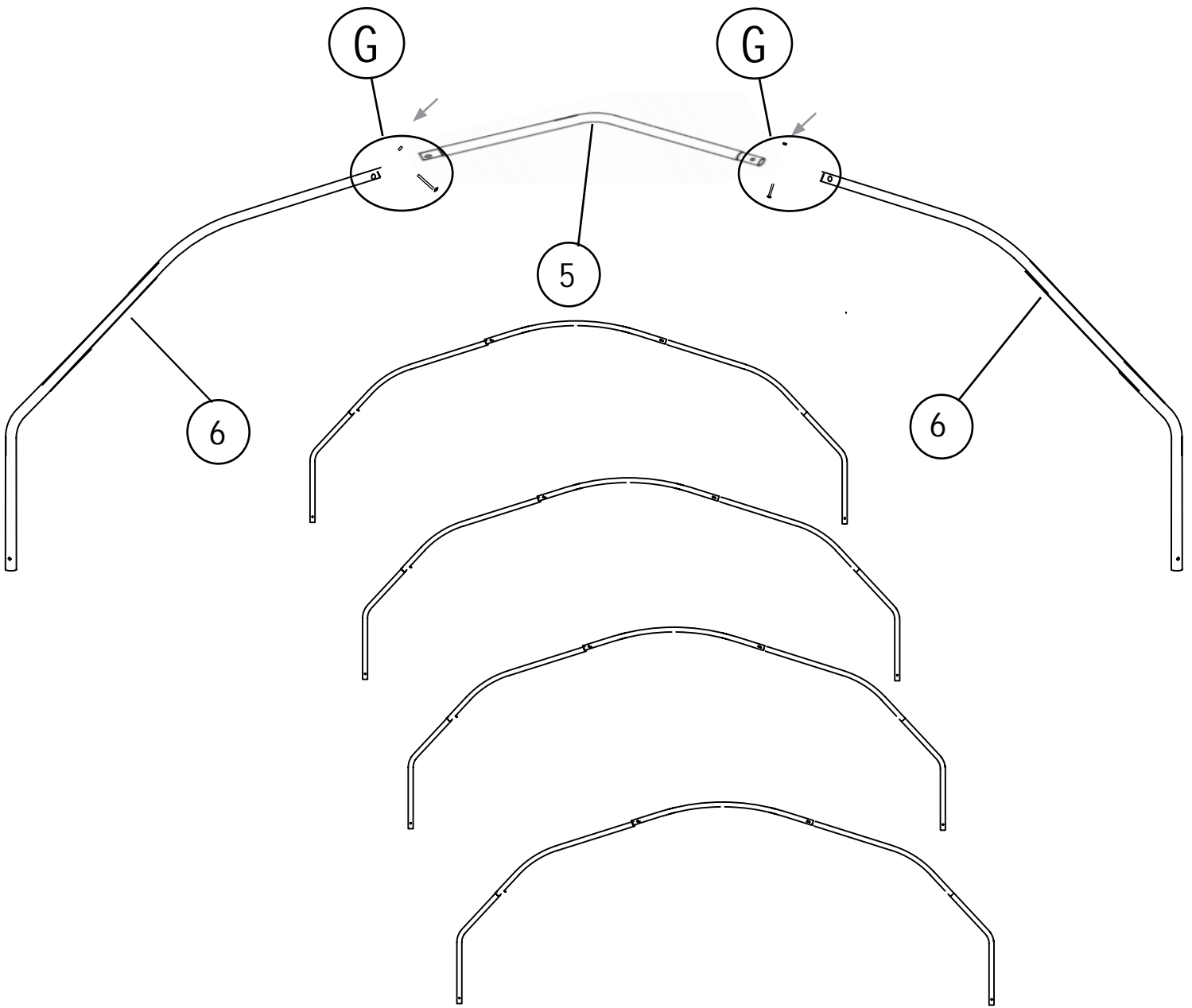
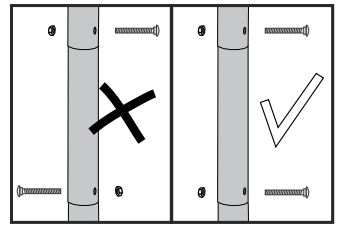

G x8	
5 x4	
6 x8	

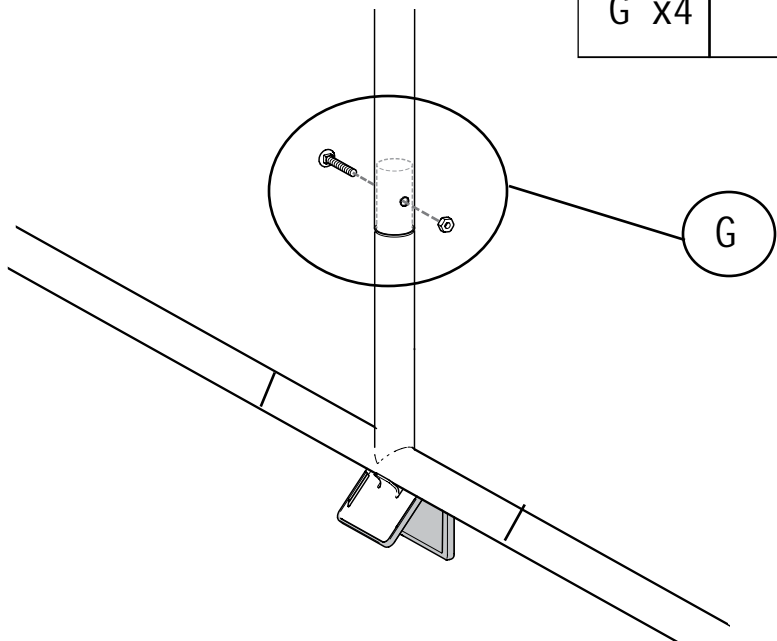
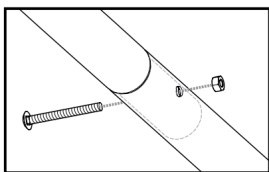
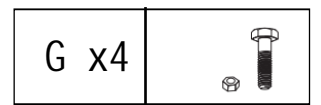
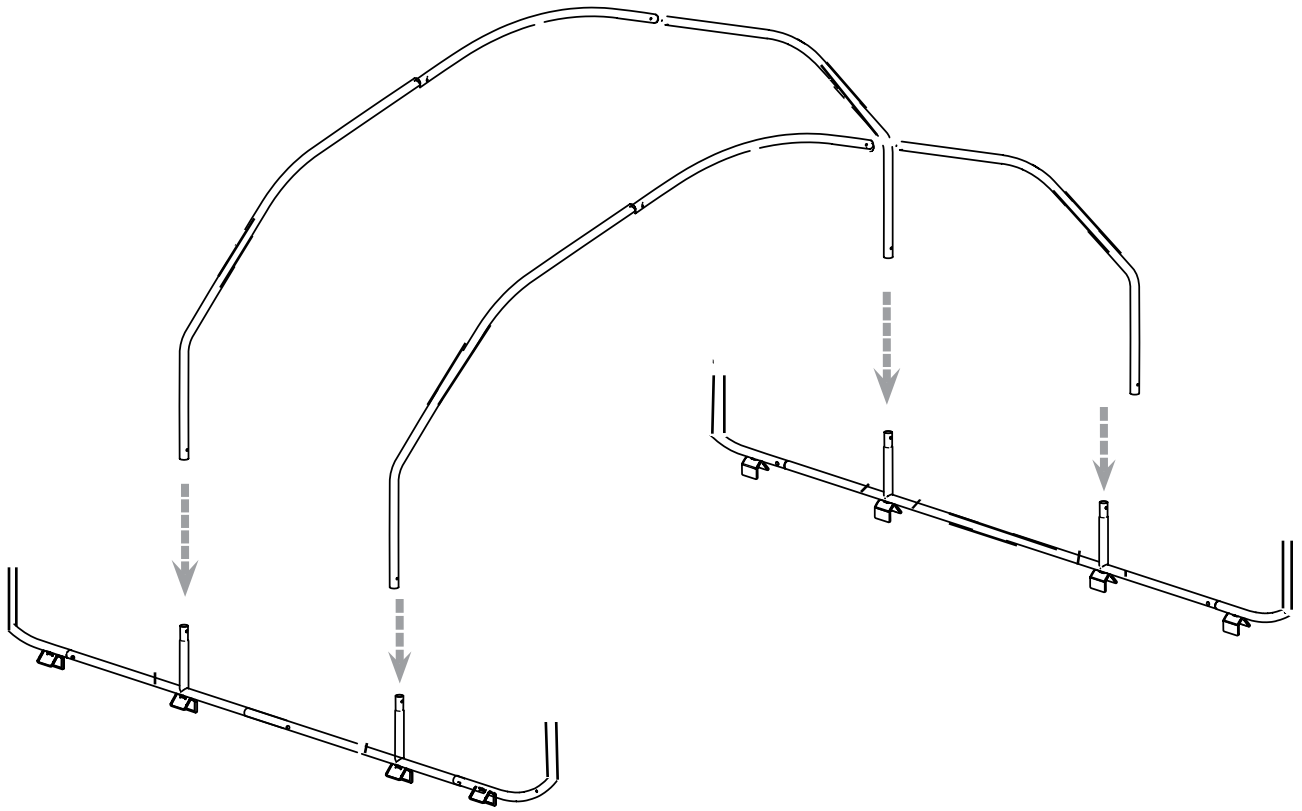
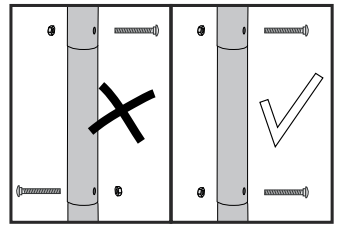

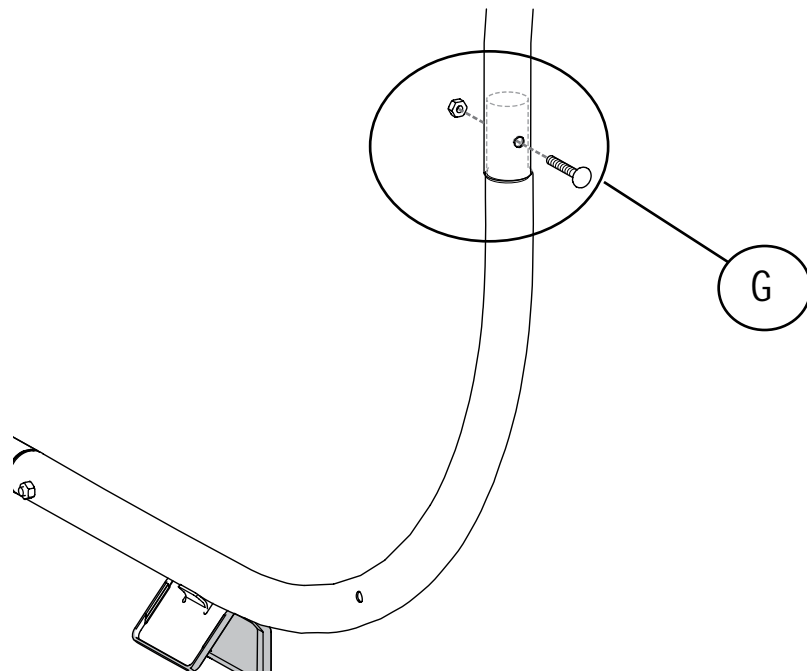
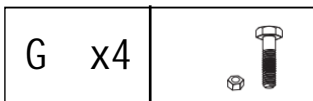
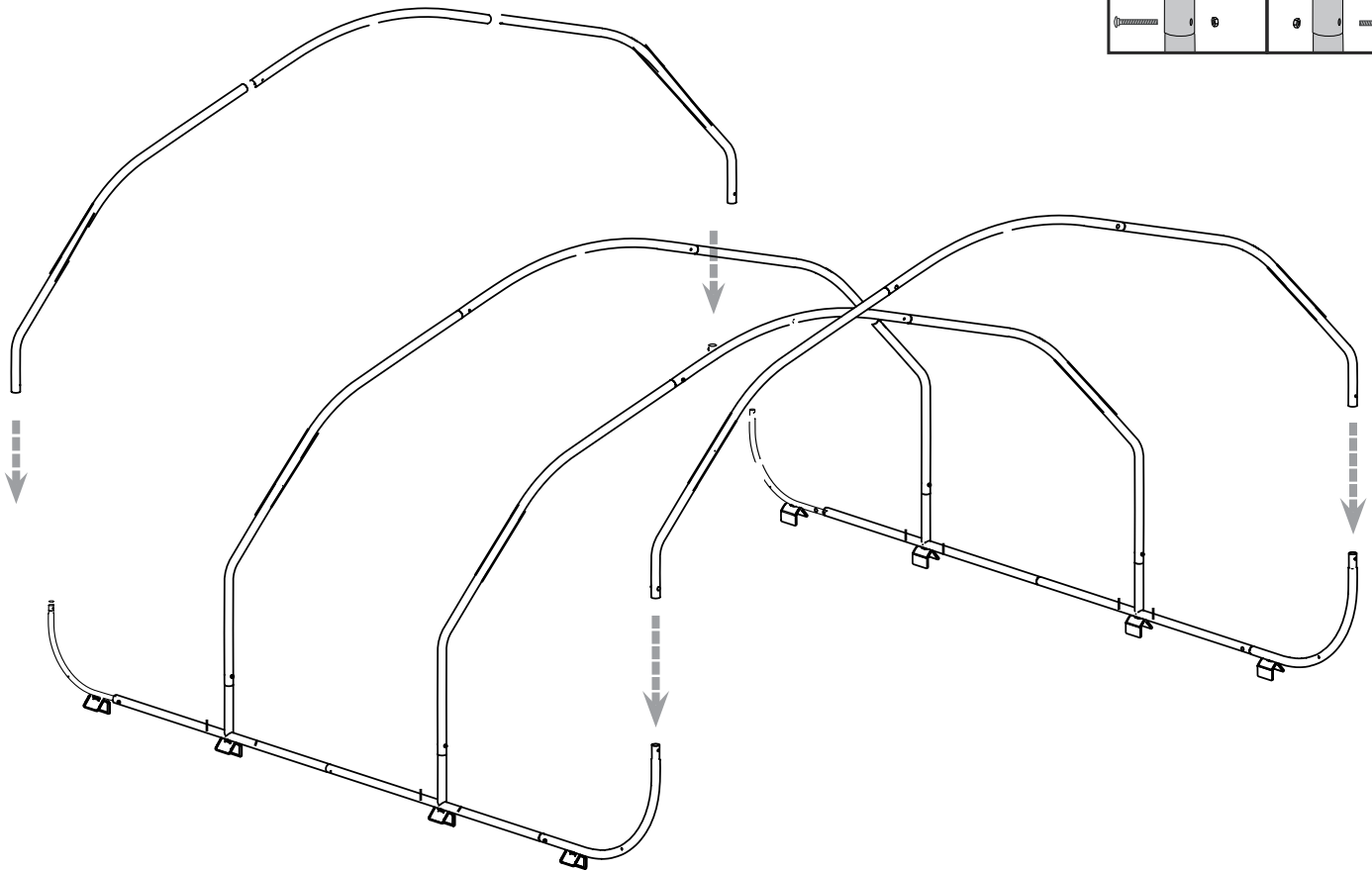
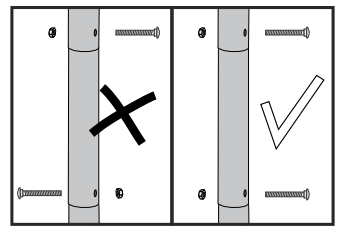



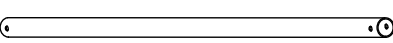

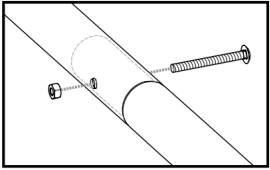
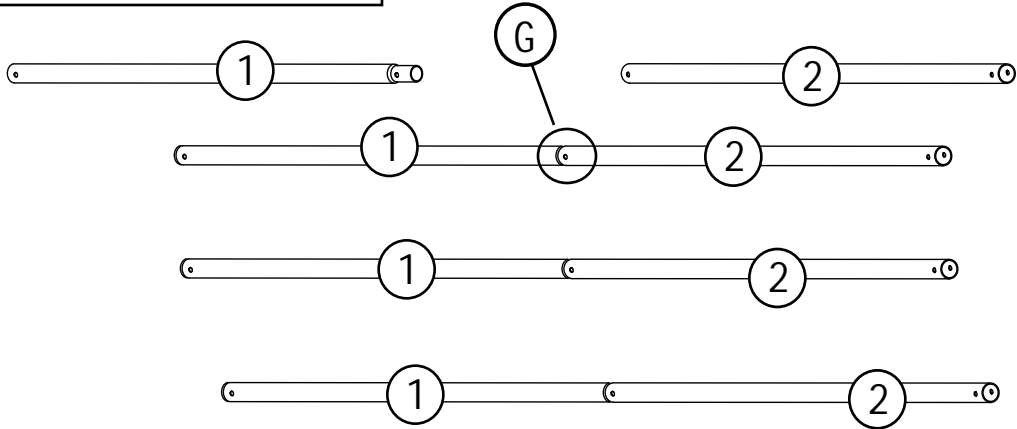
G	x3	
1	x3	
2	x3	

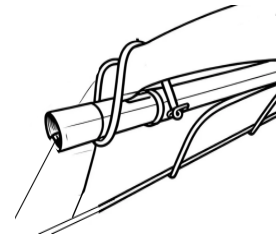
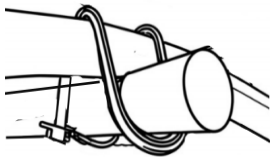
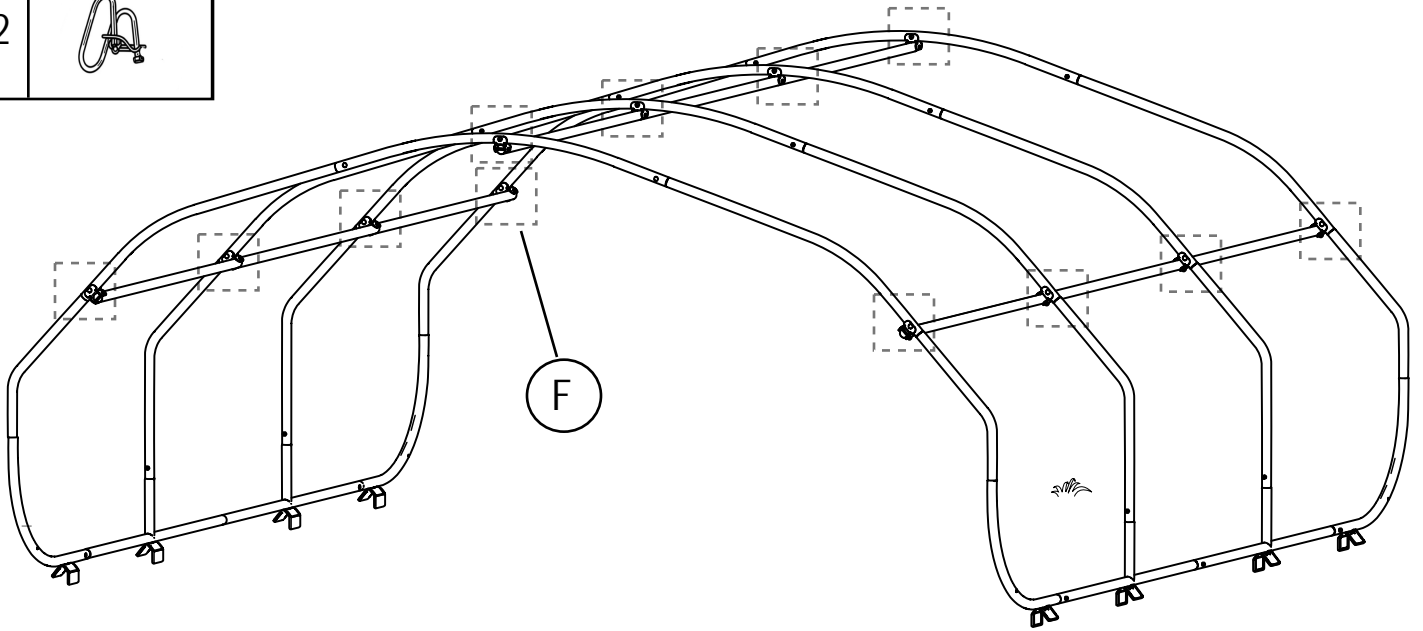

Fx12	
------	---

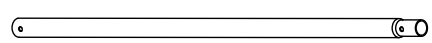

x2	
1 x2	
2 x2	