

OWNER MANUAL

 **LB**
Per Table Weight Limitation
110 LBS

 Installation:
15 minutes.







Two Person

MAINTENANCE AND WARNINGS



Before You Start

Please follow the steps below:



-  Check the packaging for any damage, deformation, or water stains. If there is significant damage, please contact us promptly.
-  Unpack the box and compare the contents with the parts list and hardware list to ensure all components and accessories are present and complete.
-  Please read the installation instructions carefully to understand the installation steps and precautions to ensure proper installation.
-  Clean the installation area in advance and ensure the ground is level and there is enough space to avoid damaging the furniture or making installation difficult.
-  Lay a protective mat on the ground to prevent scratching the floor during installation.

After-Sales Service

- If you encounter any issues or need technical support during use, please contact our after-sales team. We offer long-term maintenance and warranty services.





Precautions

-  This product is for indoor use only. Do not expose it to outdoor elements or high-humidity environments.
-  Keep the product away from high heat or open flames to prevent fire hazards.
-  Do not allow children to climb on the product, as this may cause tipping and result in personal injury.



Safety Warnings

-  If you notice any loose or damaged parts, stop using the product immediately and contact customer service.
-  Do not attempt to disassemble or replace any components yourself, as this may affect the stability and safety of the product.

Daily Maintenance

- Regularly clean the surface with a soft cloth to prevent dust accumulation.
- Do not use cleaning agents containing acids, alkalis, or corrosive substances, as they may damage the surface. It is recommended to use neutral cleaning agents or specialized furniture cleaners.
- Avoid exposing furniture to humid environments for extended periods. Use a dehumidifier or desiccant during humid weather.
- Avoid direct contact of furniture with water. If water is accidentally spilled, wipe it dry immediately.
- Avoid placing excessively heavy objects on the furniture: ensure the weight is within a reasonable load-bearing range.
- Avoid using sharp or rough items on the furniture surface to prevent scratches. Handle items gently when moving them.

Parts list

Top

A

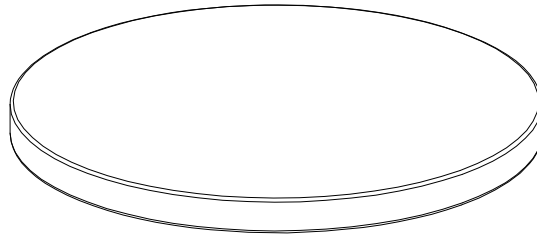

x1

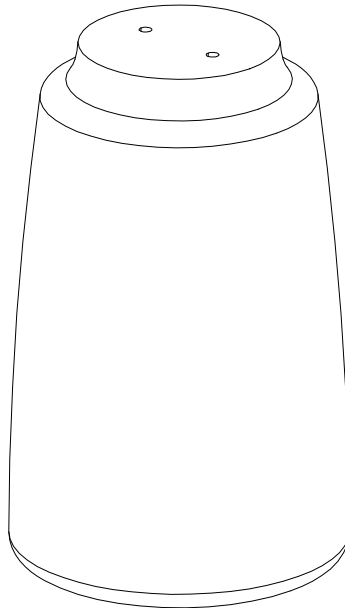

B



x1

Base

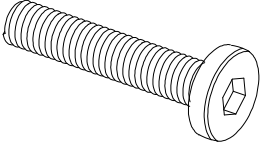
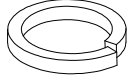
Hardware List



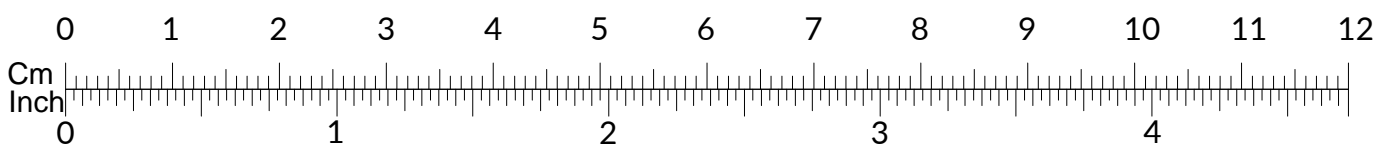
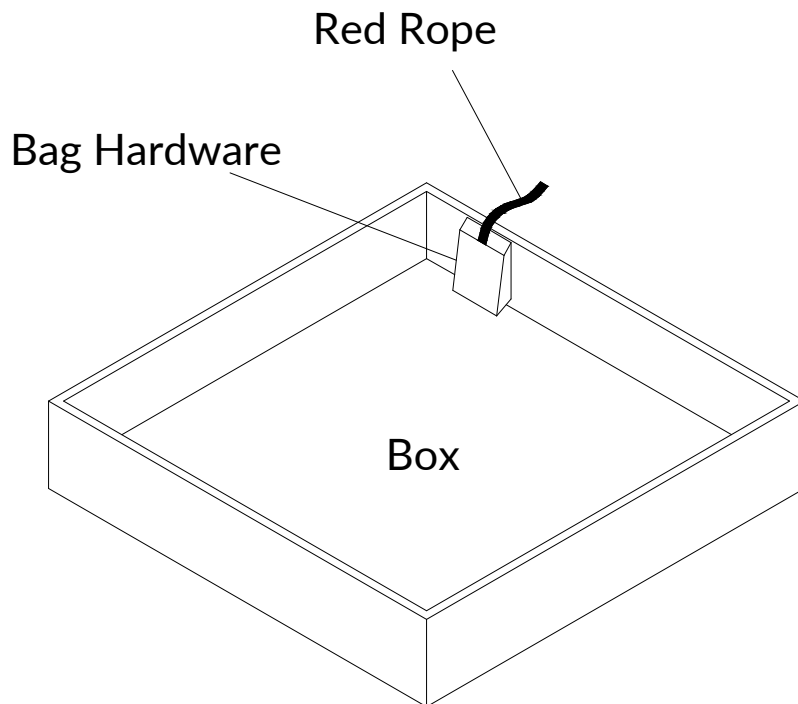

<p>①x2 Bolt</p>  <p>M8x40 mm</p>	<p>②x2 Spring Washer</p>  <p>Ø8x12 mm</p>	<p>③x2 Washer</p>  <p>Ø8x22 mm</p>
<p>④x1 Allen Key</p>  <p>L20 mm</p>		

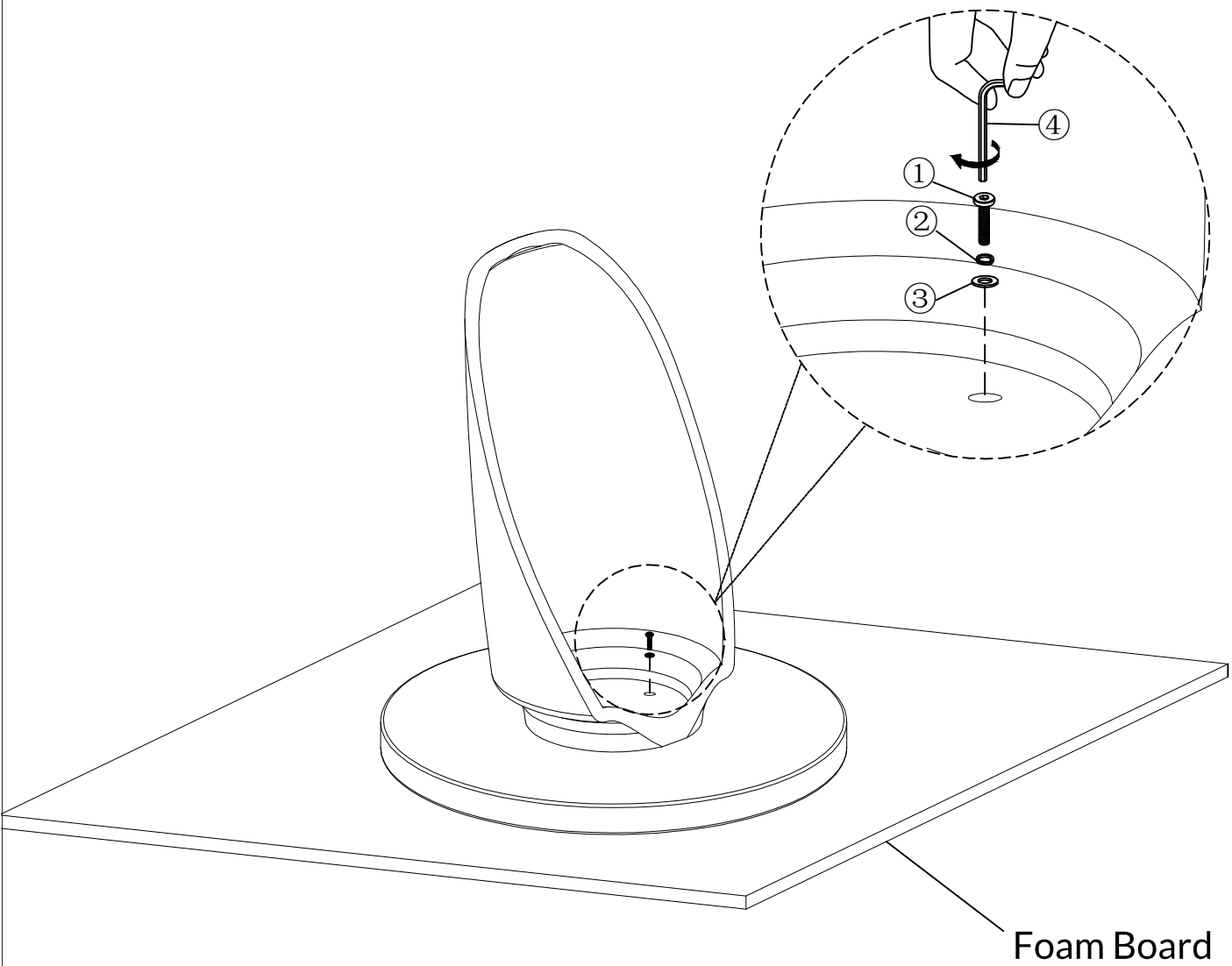

Note: Before installing the screws, please first distinguish the length of the screw rods.

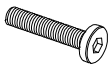
Step 1



①x2	②x2	③x2	④x1
			
M8x40 mm	Ø8x12 mm	Ø8x22 mm	M4

Step 2

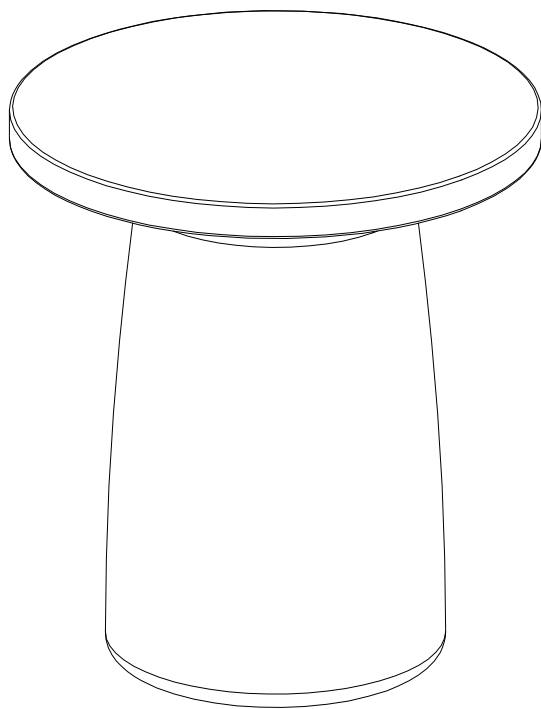

Assembly completed.

WARRANTY

- We strive to offer quality products, and we also try our best to satisfy every customer who orders from us with products or services as needed.
- Replacement parts can be purchased from our company if available.
- For returns, please check the return policy with the retailer or marketplace where you purchased the item.

We appreciate your purchase.
Brighten your life with our furniture!