

## ASSEMBLY INSTRUCTIONS

### ASSEMBLY TIPS:

1. Remove hardware from box and sort by size.
2. Please check to see that all hardware and parts are present prior to start of assembly.
3. Please follow attached instructions in the same sequence as numbered to assure fast & easy assembly.















### WARNING!

1. Don't attempt to repair or modify parts that are broken or defective. Please contact the store immediately.
2. This product is for home use only and not intended for commercial establishments.

ASSEMBLY TIME



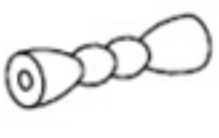

30 MINUTES

### PARTS IDENTIFICATION

A	TOP & BOTTOM PANEL		2PCS
B	BRACES		4PCS
C	FRONT CROSSBAND		2PCS
D	SHELF PANEL		1PC
E	LONG POST		2PCS
F	SHORT POST		2PCS
G	HANDLE		1PC
H	LEG		4PCS
I	POST		2PCS
J	LEFT & RIGHT		2PCS
K	PLASTIC DECORATION		18PCS
L	CROWN MOULDING		2PCS

## ASSEMBLY INSTRUCTIONS

### HARDWARE IDENTIFICATION

1	WASHER (Ø 19mm RBW)		2PCS
2	BOLT (3/16" x 54mm RBW)		18PCS
3	CASTER (Ø 40mm BLK)		4PCS
4	BOX WRENCH (60mm)		1PC

## ASSEMBLY INSTRUCTIONS STEP 1

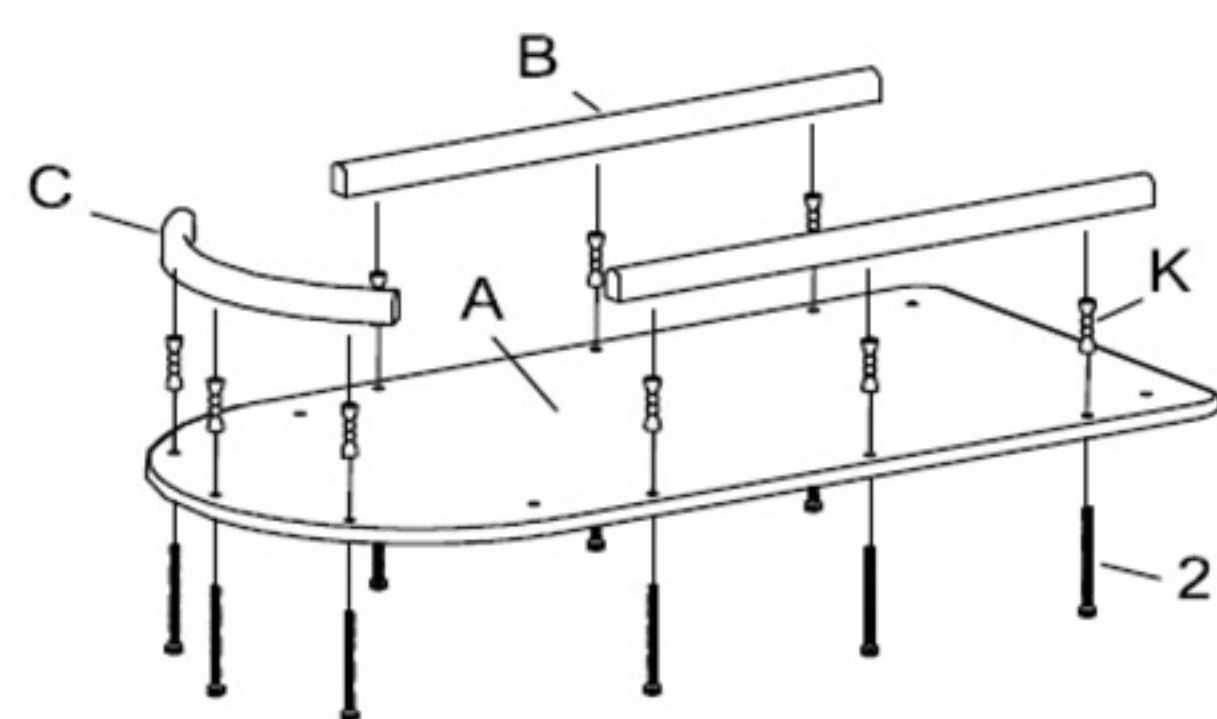

## STEP 2

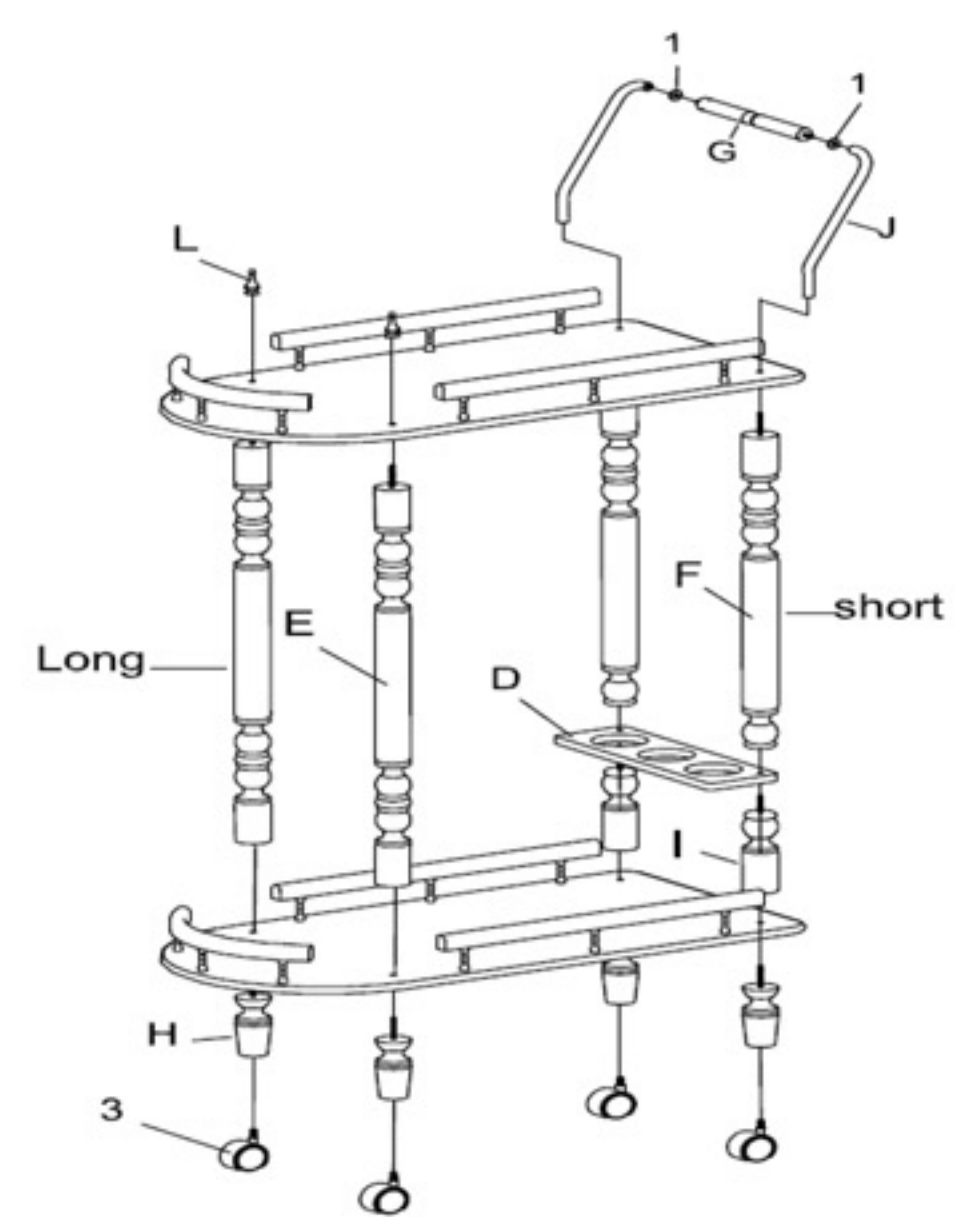

## STEP 3

### COMPLETE

