

STEP 1

A		PLASTIC DOWEL M8 X 25MM	18
---	--	-------------------------	----

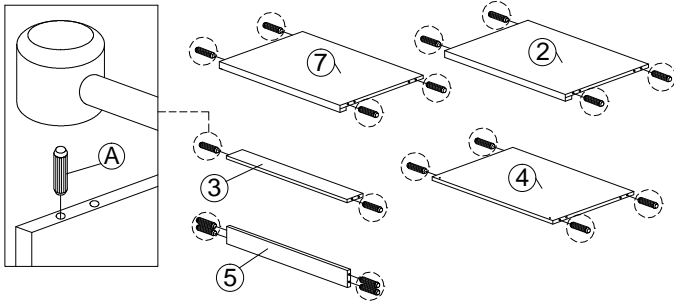

STEP 2

A		PVC SHELF SUPPORT	4
---	--	-------------------	---

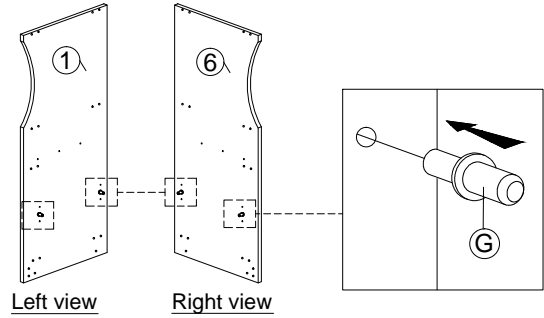

STEP 3

B		CB SCREW M3.5 X 12MM	6
U		DRAWER SLIDE 14"	1

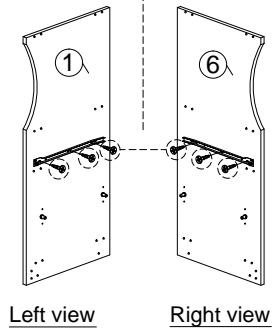
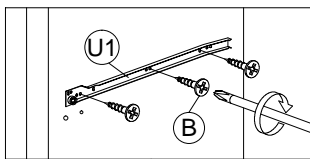

STEP 4

O		902 MAGNET	12
---	--	------------	----

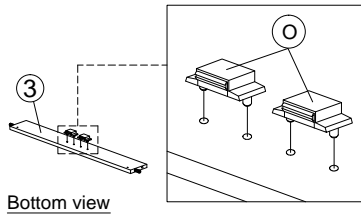

STEP 5

H		DOOR SUPPORT SPRING	4
---	--	---------------------	---

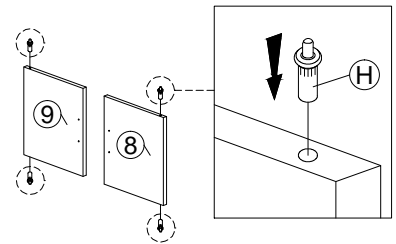

STEP 6

J		MOON HANDLE C211 (96MM)	2
K		P/H SCREW M4 X 20MM	4

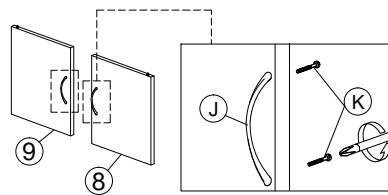

STEP 7

N		MAGNET PLATE	2
P		CB SCREW M3 X 12MM	2

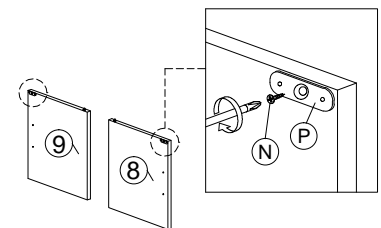

STEP 8

E		CSK CAP M6 X 40MM	7
I		ALLEN KEY	1
M		CAP	7

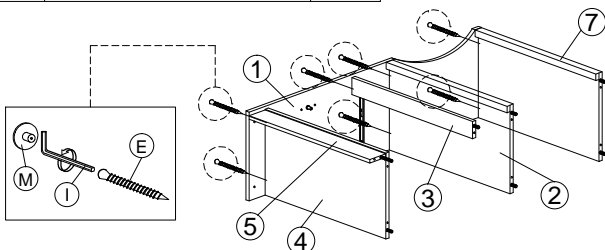

STEP 9

E		CSK CAP M6 X 40MM	7
I		ALLEN KEY	1
M		CAP	7

