



**INSTRUCTIONS D'ASSEMBLAGE
ASSEMBLY INSTRUCTIONS**

**TABLE D'APPOINT -
TAUPE FONCE ET METAL CHROME**



**ACCENT TABLE -
DARK TAUPE WITH CHROME METAL**



**POUR DE L'ASSISTANCE OU POUR COMMANDER
DES PIÈCES CONTACTEZ NOTRE DÉPARTEMENT
DE SERVICE À LA CLIENTÈLE.**

**FOR ASSISTANCE OR TO ORDER PARTS
CONTACT OUR CUSTOMER SERVICE DEPARTMENT**

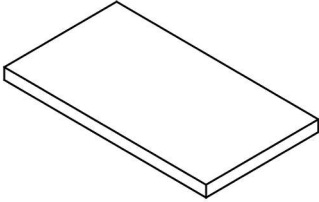
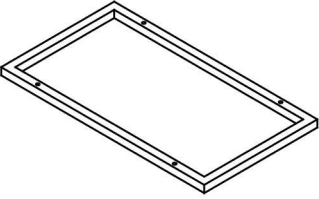
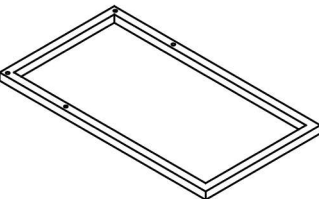
LISTE DES PIÈCES
PARTS LIST

PIÈCE / PART #	IMAGE	DESCRIPTION	QTY / QTÉ
1		<p style="text-align: center;">TABLE TOP SURFACE DE TABLE</p>	1
2		<p style="text-align: center;">TOP FRAME CADRE DE SURFACE</p>	1
3		<p style="text-align: center;">BOTTOM FRAME CADRE DU BAS</p>	1
4		<p style="text-align: center;">FRONT FACING LEFT LEG PATTE AVANT GAUCHE</p>	1
5		<p style="text-align: center;">FRONT FACING RIGHT LEG PATTE AVANT DROITE</p>	1

LISTE DES PIÈCES DE MONTAGE
HARDWARE LIST

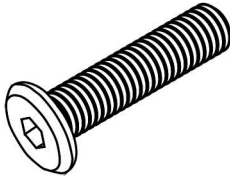
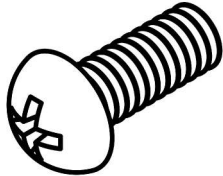
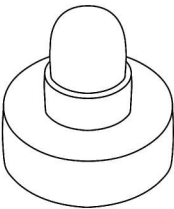
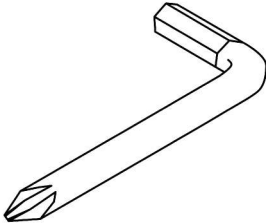
PIÈCE / PART #	IMAGE	DESCRIPTION	QTY / QTÉ
A		ASSEMBLING SCREW - Ø3/8" X 1 1/4" VIS D'ASSEMBLAGE - Ø3/8" X 1 1/4"	4
B		ASSEMBLING BOLT - Ø1/4" X 7/8" BOULON D'ASSEMBLAGE - Ø1/4" X 7/8"	4
C		ASSEMBLING BOLT - Ø1/8" X 1/2" BOULON D'ASSEMBLAGE - Ø1/8" X 1/2"	4
D		FLOOR PROTECTOR - Ø1/4" PROTECTEUR DE PLANCHER - Ø1/4"	4
E		HEX KEY CLÉ HEXAGONALE	1

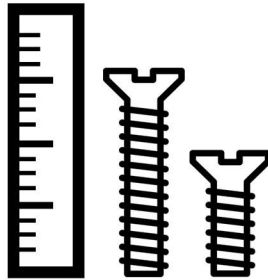

OUTIL DE VÉRIFICATION DE DIMENSIONS DES PIÈCES
HARDWARE DIMENSIONS VERIFICATION TOOL

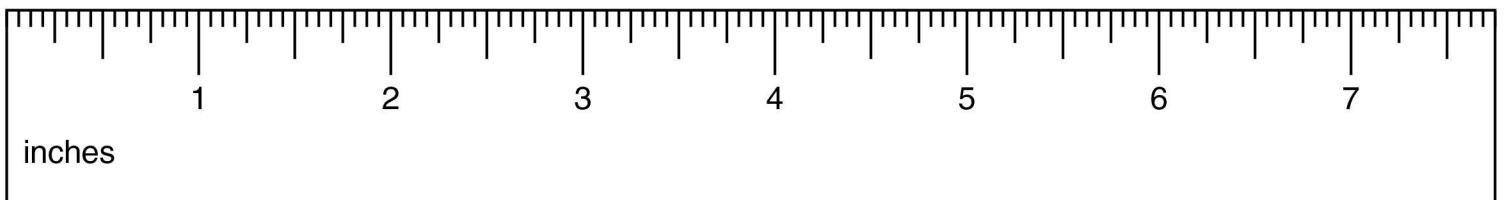

ÉTAPE / STEP 1

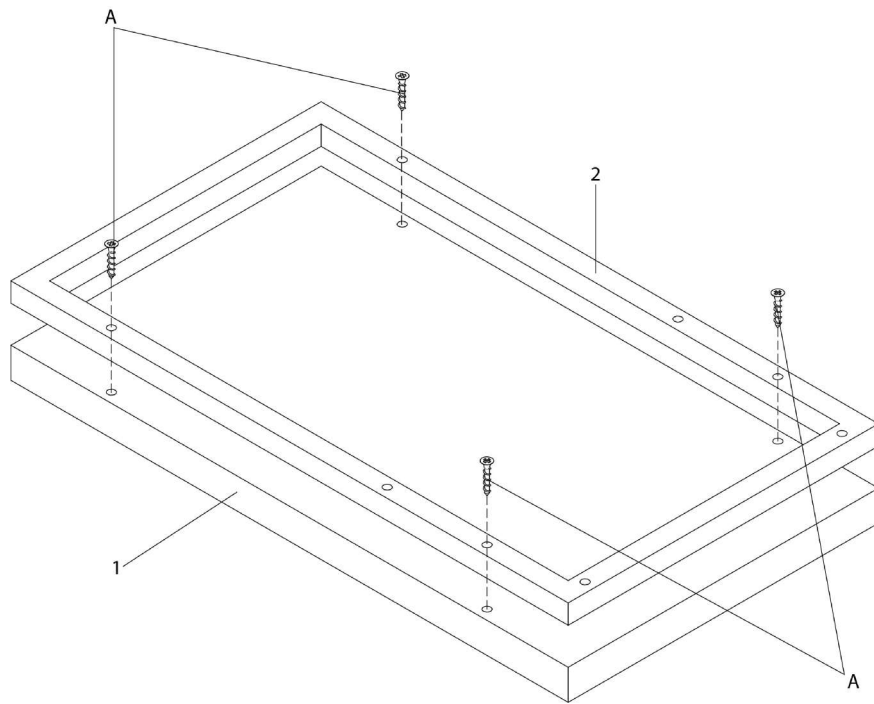

ÉTAPE / STEP 2

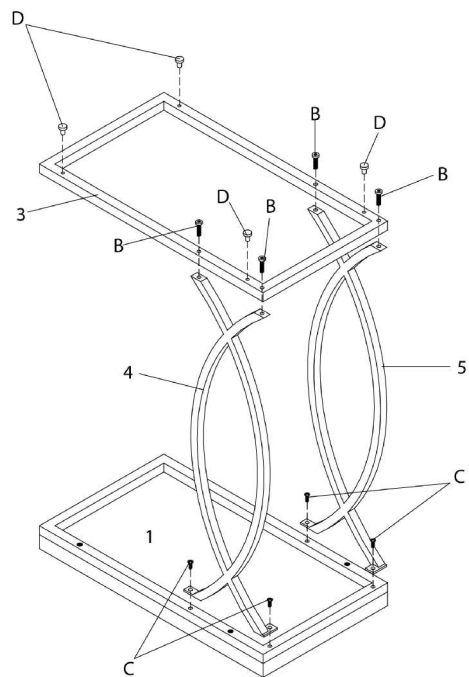

ÉTAPE / STEP 3

