

THIS INSTRUCTION BOOKLET CONTAINS IMPORTANT SAFETY INFORMATION. PLEASE READ AND KEEP FOR FUTURE REFERENCE.

ESTE FOLLETO DE INSTRUCCION CONTIENE INFORMACION IMPORTANTE DE SEGURIDAD. POR FAVOR, LEALA Y GUARDELA PARA PODER USARLA EN UN FUTURO.

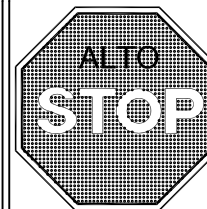

DO NOT RETURN PRODUCT TO THE STORE
Individual stores do not stock parts.

NO DEVUELVA ESTE PRODUCTO A LA TIENDA
Las tiendas no almacenan partes.

Lot Number / N^omero de Lote: _____

Date Of Purchase / Fecha de Compra: ___/___/___

If a part is missing or damaged, call our toll-free customer service line. We will gladly ship your replacement parts FREE of charge.

Si faltan partes o piezas, o éstas están dañadas, llame gratis al teléfono de servicio al cliente. Con gusto le enviaremos las partes sin cargo alguno.

For prompt, reliable service please have your assembly manual ready.
Para obtener un servicio rápido y confiable, por favor guarde este manual para tenerlo siempre a mano.

Recommended # of people needed for assembly: 2

El número recomendado de personas necesarias para el montaje: 2

Before starting - Antes de empezar.

- Read each step carefully before starting. It is very important that each step of instruction is performed in the correct order. If these steps are not followed in sequence, assembly difficulties will occur.
Leer con cuidado cada paso antes de empezar. Es muy importante de ejecutar cada paso en el orden correcto. Si los pasos no están ejecutados en secuencia, ocurrirá dificultades en el montaje.
- Make sure all parts are included. Most board parts are labeled or stamped on the raw edge.
Asegurar que todas las piezas son incluidas. La mayoría de las tablas tienen las etiquetas o los sellos en el lado sin acabado.
- Work in spacious area, preferably on a carpet, near the place the unit will be used.
Trabajar en una área espaciosa, preferible sobre alfombra, cercas del lugar donde se va a usar el mueble.
- Have the following tools close at hand.
Tener las herramientas siguientes cerca de la mano.
- Do not use power tools to assemble your furniture. Power tools may strip or damage the parts.
No use herramienta eléctrica para montar su unidad. Las herramientas eléctricas pueden dañar las piezas.

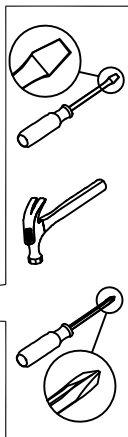

HELPFUL HINTS

- Visit our website for assembly video clips.
- Identify, sort and count the parts before attempting assembly.
- Call our toll free number if you need assistance identifying parts.
- Compression dowels are tapped in with a hammer.
- Slides have lips only on the right side.
- Cam locks that are properly fastened on a horizontal board will face toward the center of the unit, on a vertical board the point on the lock will face the bottom.
- Back panels provide stability and support. Use all the nails provided.
- When tapping nails into a board, be sure there are equal margins on all sides to square the unit.
- Units without the back panel installed may collapse.
- Clean the product with your favorite furniture polish and a soft cloth. **DO NOT USE** harsh chemicals or abrasive cleaners.
- Move your new furniture carefully, with two people lift and carry the unit to its new location.
- Never push, drag or scoot your furniture (especially on carpet).
- Your furniture can be disassembled and reassembled to move.
- Additional parts are available for a nominal fee.

NOTES UTILES

- Visitar nuestro website para mirar los videos cortos del montaje.
- Identificar, clasificar y contar las piezas antes de intentar el montaje.
- Llamar gratis a nuestro número de servicio si necesita ayuda con identificar las piezas.
- Las clavijas de compresión se taladran con un martillo.
- Las correderas sólo tienen las proyecciones en el lado derecho.
- Las cerraduras de leva que se atan propiamente en una tabla horizontal se puntan al centro de la unidad, y las en una tabla vertical se puntan al fondo.
- Los paneles traseros se mantienen la estabilidad. Usar todos los tornillos proporcionados.
- A taladrar los tornillos en una tabla, asegurarse que hay márgenes iguales en todos los lados para cuadrar la unidad.
- Las unidades sin panel trasero pueden derrumbarse.
- Limpiar la unidad con su pulimento favorito de mueble y una tela suave. **NO UTILIZAR** productos con químicos duros o abrasivos.
- Mover su mueble nuevo cuidadosamente, con dos personas levantar la unidad a su nuevo lugar.
- Nunca empujar o arrastrar su mueble (especialmente en alfombra).
- Poderse desmontar y volver a montar su mueble de para mover.
- Piezas adicionales están disponibles para una cuota nominal.

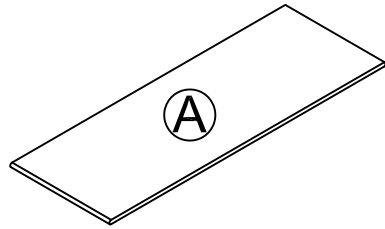

Top shelf
Estante superior

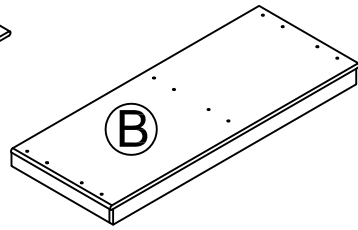

Bottom panel
Panel del

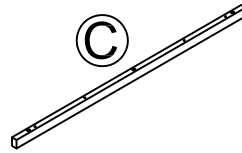

Top shelf apron
Embellecedor para estante superior

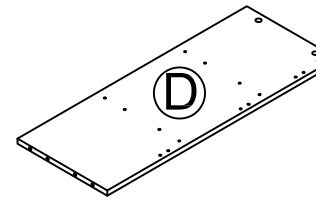

Partition panel
Panel de partici3n

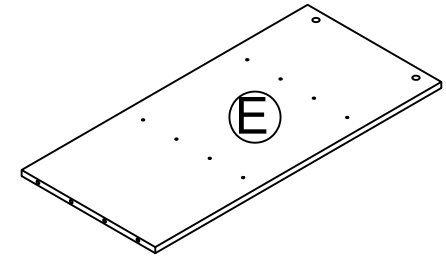

Left side panel
Panel izquierdo

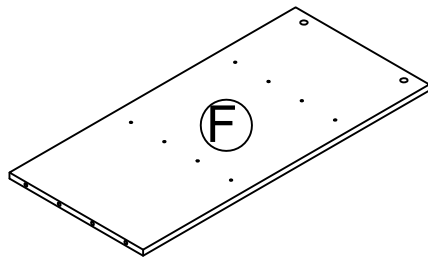

Right side panel
Panel derecho

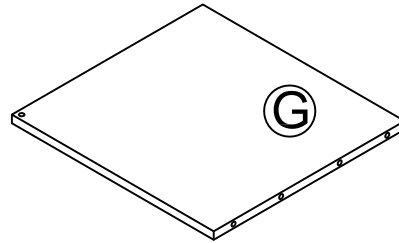

Left fixed shelf (2)
Estante fijo izquierdo (2)

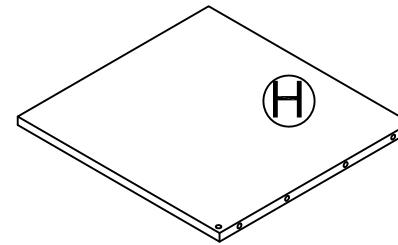

Right fixed shelf (2)
Estante fijo derecho (2)

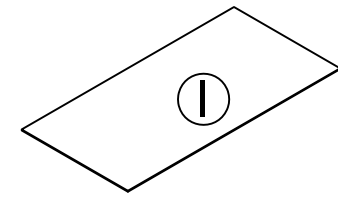

Back panel (2)
Panel trasero (2)

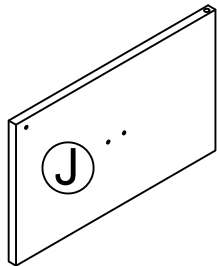

Upper left door
Puerta izquierda superior

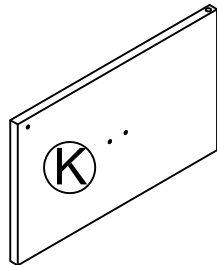

Middle left door
Puerta izquierda en la mitad

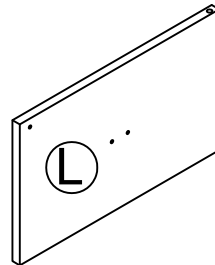

Lower left door
Puerta izquierda inferior

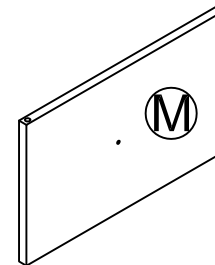

Upper right door
Puerta derecha superior

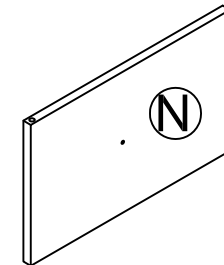

Middle right door
Puerta derecha en la mitad

PARTS -PIEZAS

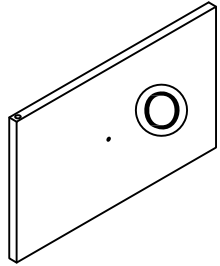

Lower right door
Puerta derecha inferior

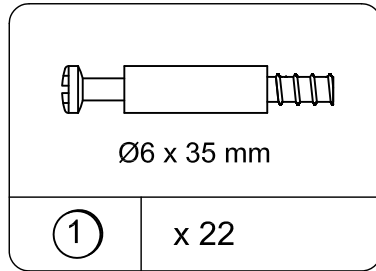

Cam bolt
Perno de la leva
TWQ0011

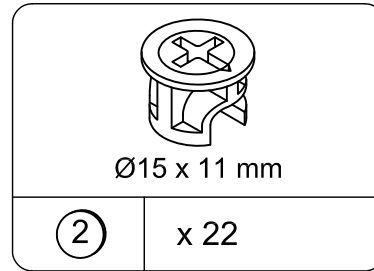

Cam lock
Cerradura de la leva
TWQ0012

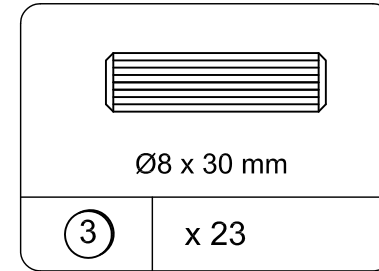

Wooden dowel
Clavija de madera
TWQ0003

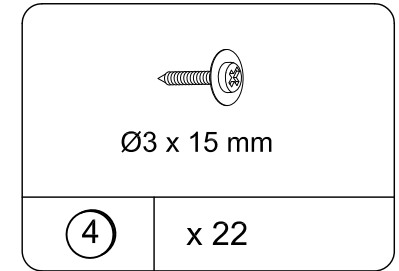

Screw
Tornillo
TWQ0009

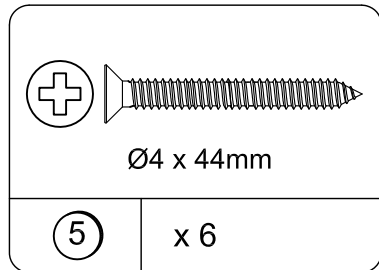

Screw
Tornillo
TWQ0027

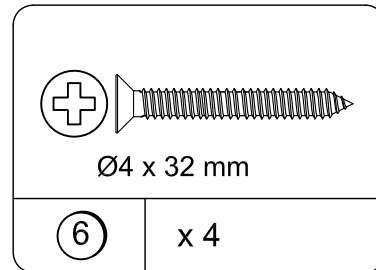

Screw
Tornillo
TWQ0010

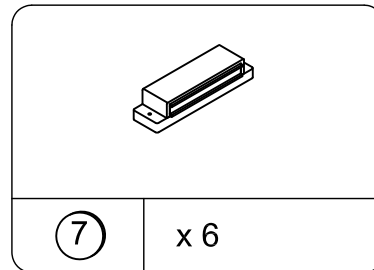

Magic catch
Pestillo mágico
TWQ0035

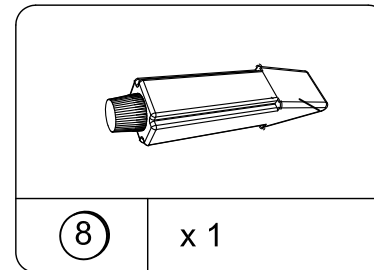

Glue
Pegamento
TWQ0008

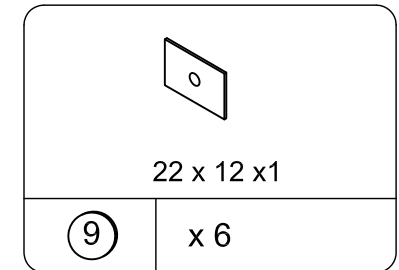

Magic catch plate
Placa de pestillo mágico
TWQ0036

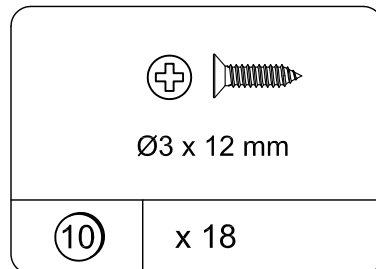

Screw
Tornillo
TWQ0037

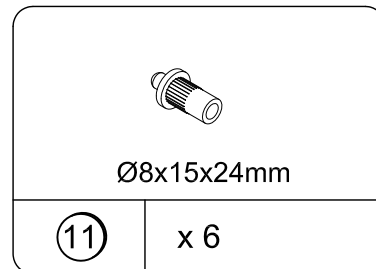

Door shaft
Eje de puerta
TWQ0038

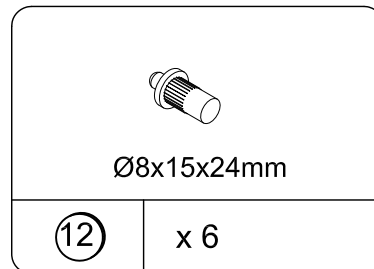

Door shaft
Eje de puerta
TWQ0039

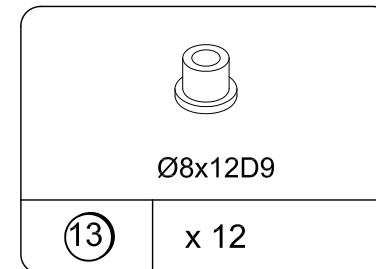

Door shaft support
Soporte para eje de puerta
TWQ0040

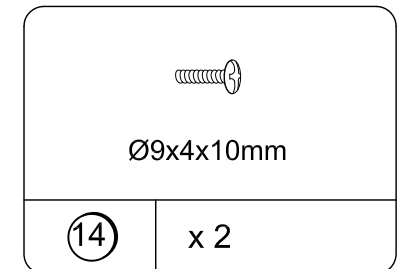

Screw bolt
Tornillo con tuerca
TWQ0034

PARTS -PIEZAS

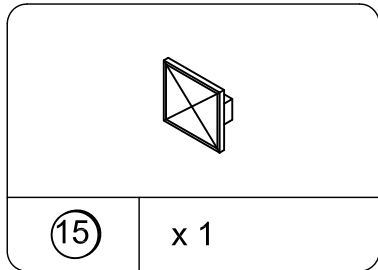

Knob
Puno
TWQ0029

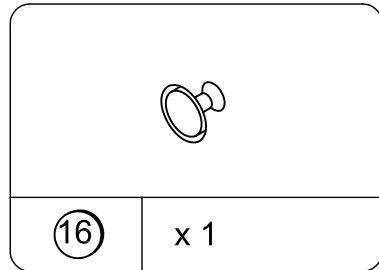

Knob
Puno
TWQ0030

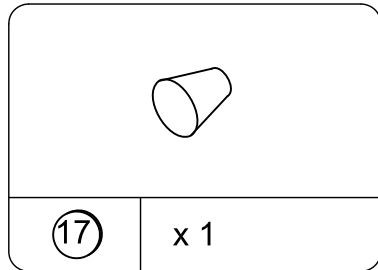

Knob
Puno
TWQ0041

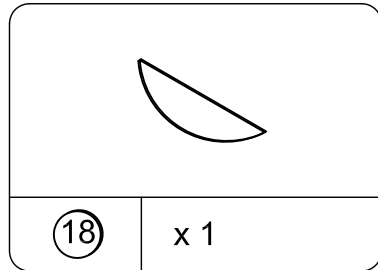

Pull
Jalón
TWQ0031

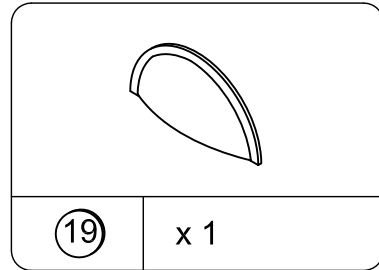

Pull
Jalón
TWQ0032

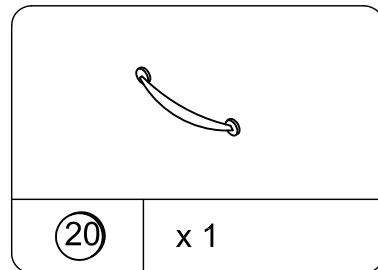

Handle
Manija
TWQ0042

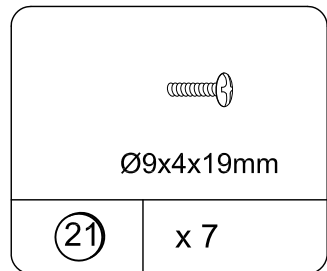

Screw bolt
Tornillo con tuerca
TWQ0033

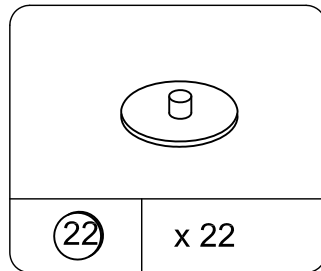

Cam cover
Leva de cubierta
TWQ0013

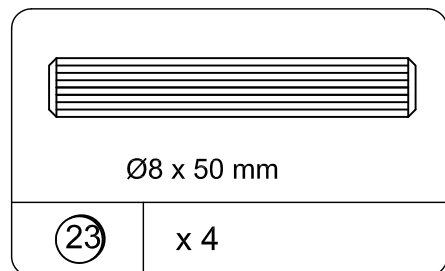

Wooden dowel
Clavija de madera
TWQ0055

This illustration shows how the cam fastening system works.
Esta ilustración muestra como funciona el sistema de fijación de leva.

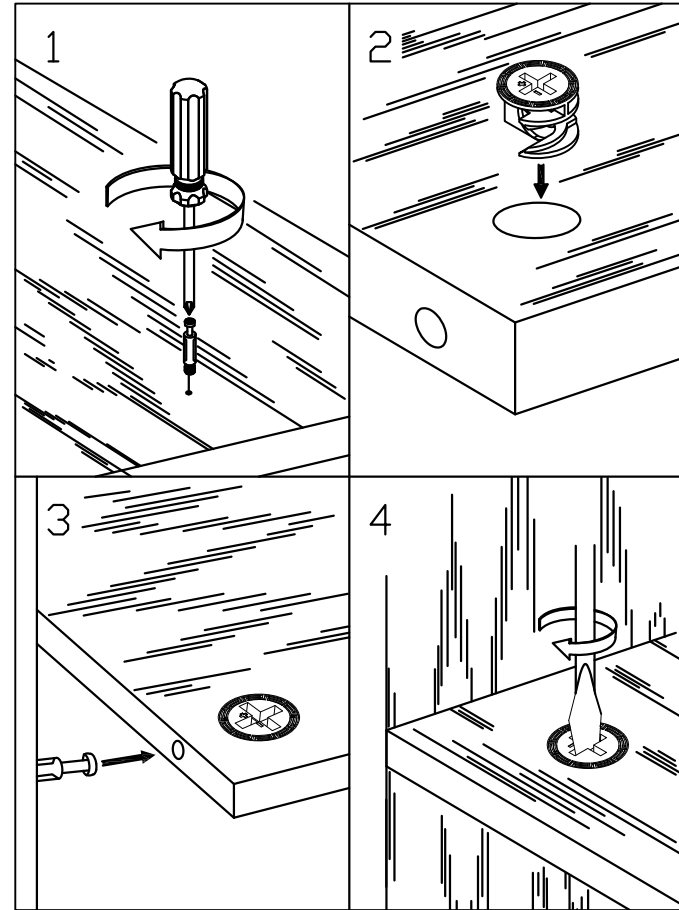

1

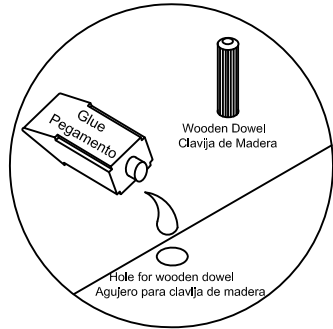

Use one drop of glue in dowel hole.
Use una gota de pegamento en el agujero de clavija.

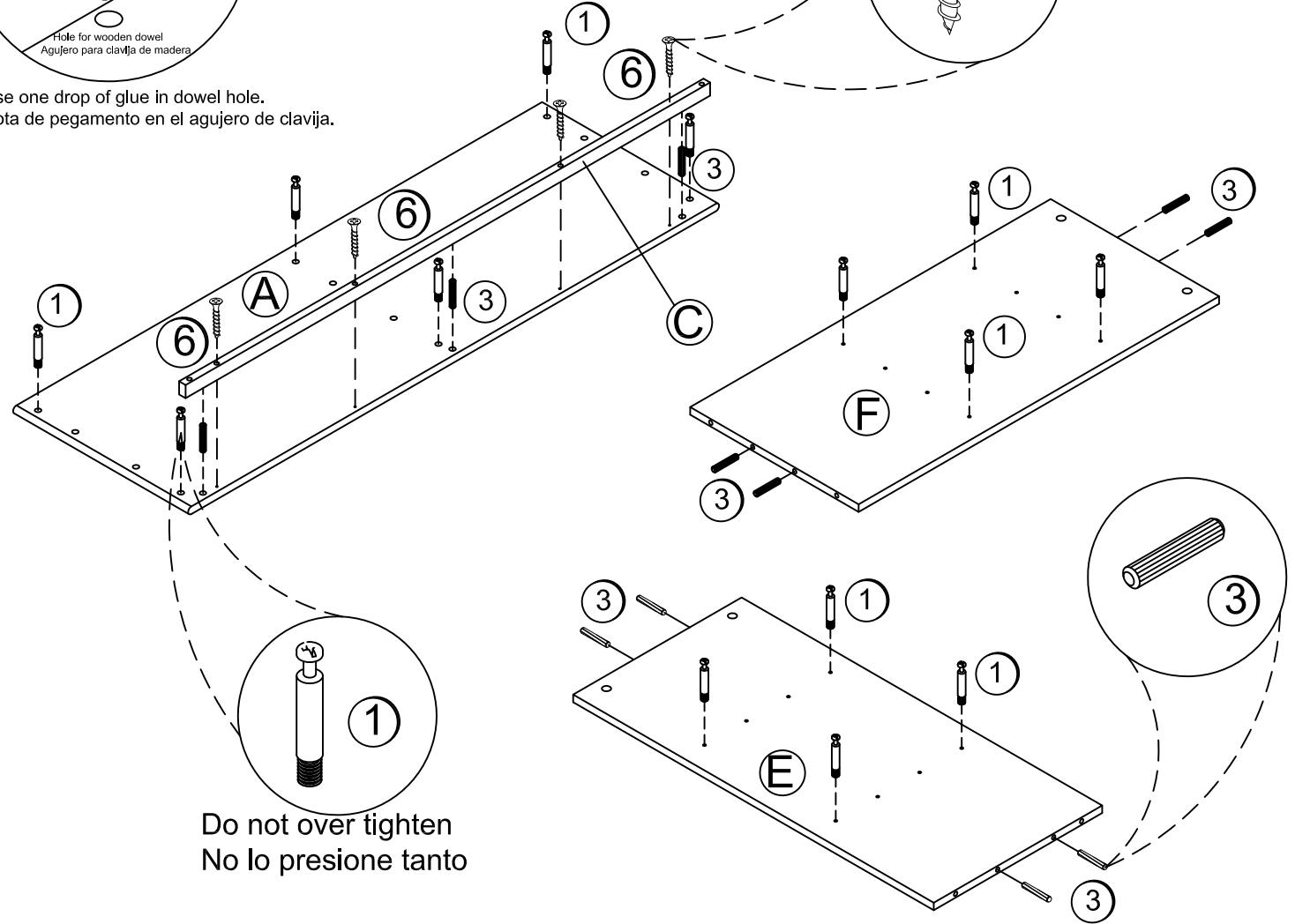
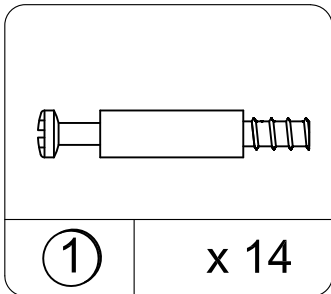
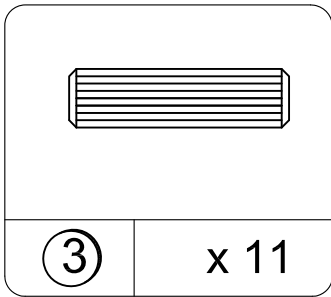
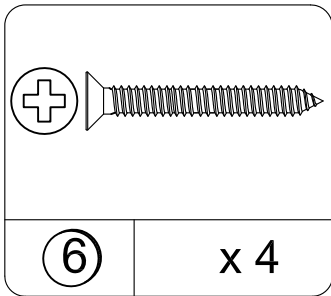

Do not over tighten
No lo presione tanto

2

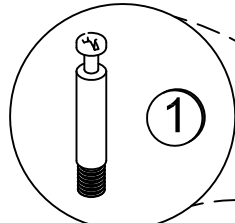

Do not over tighten
No lo presione tanto

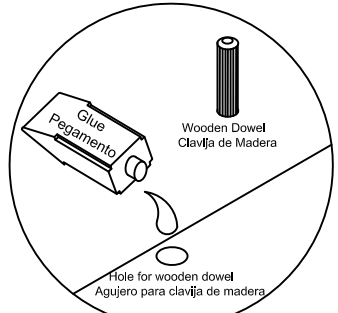
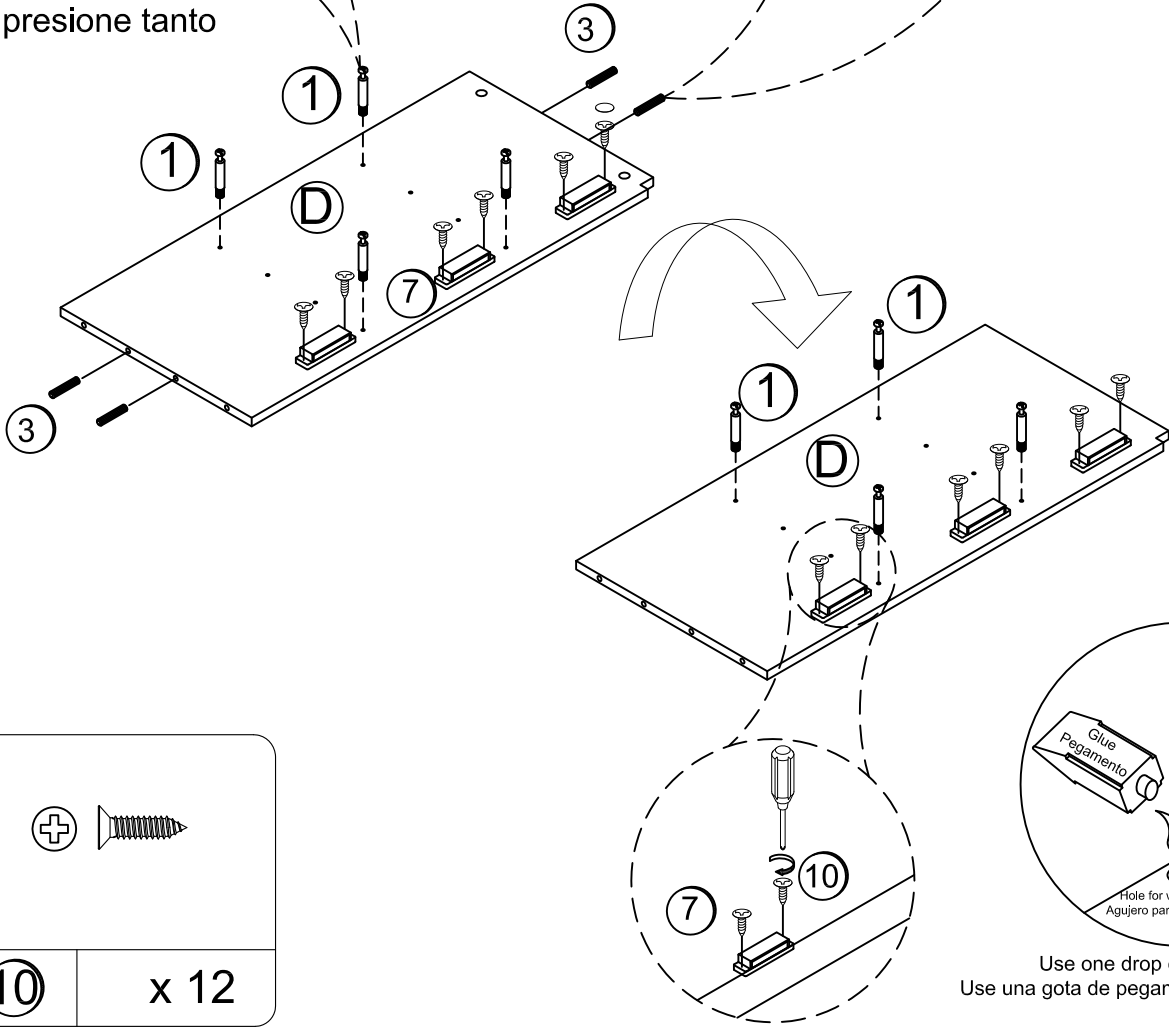
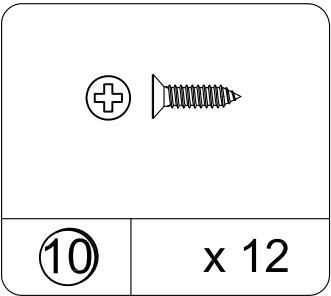
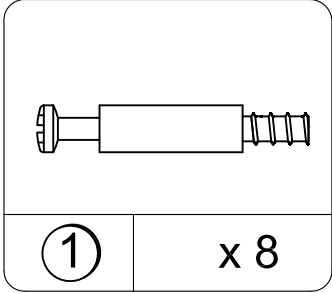
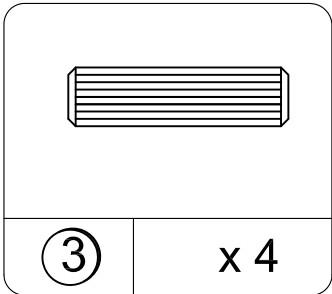
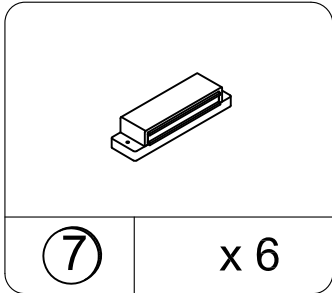
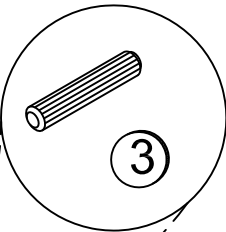

Use one drop of glue in dowel hole.
Use una gota de pegamento en el agujero de clavija.

3

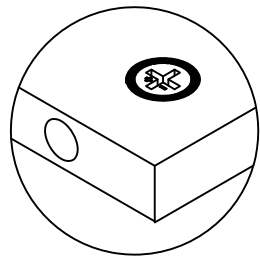
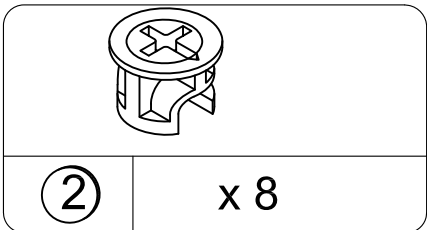
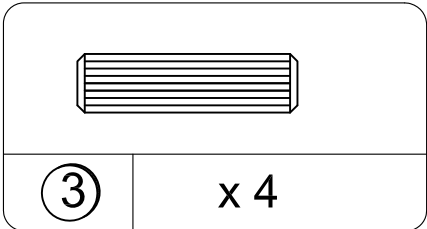
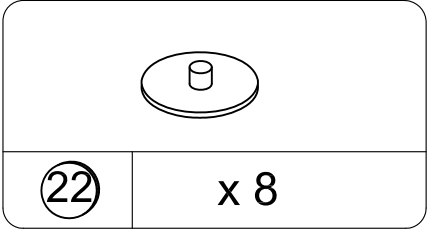
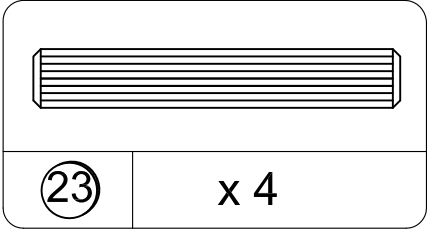
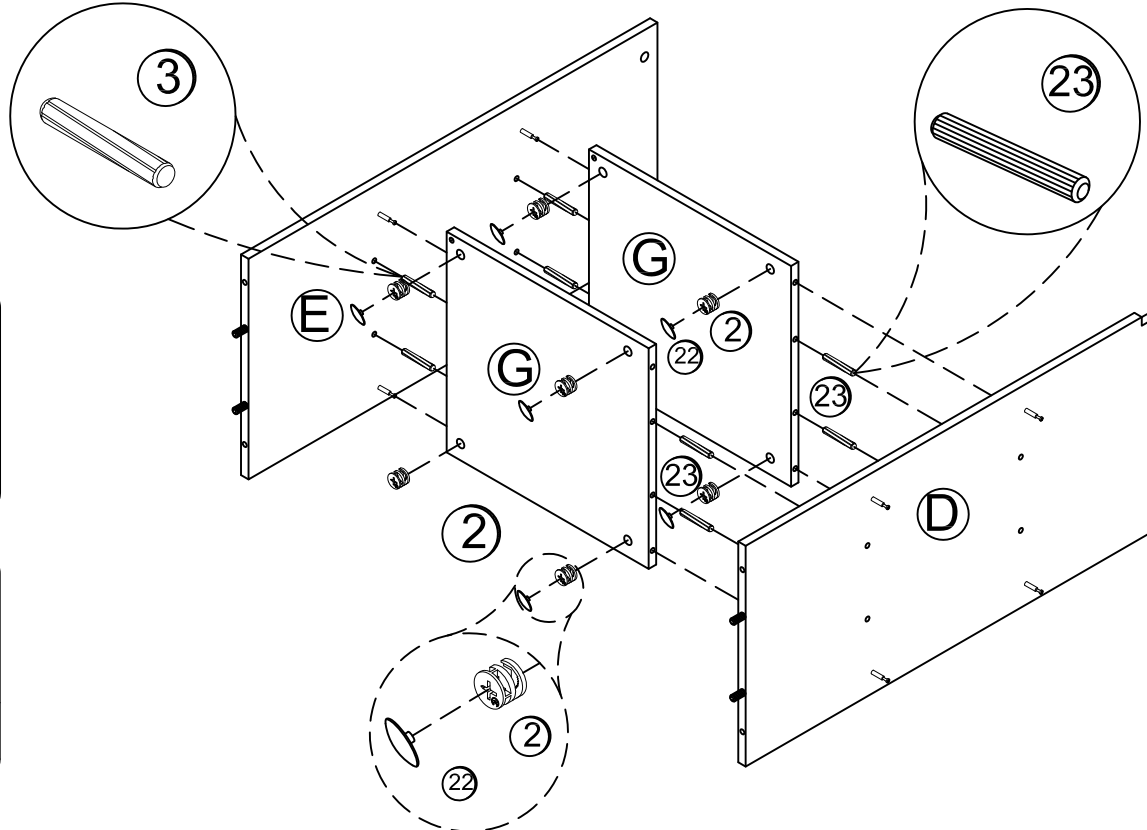

Proper orientation of cam lock
La orientación apropiada para el seguro de bloqueo

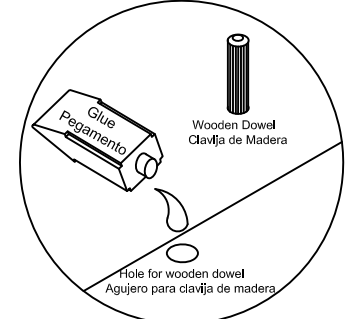
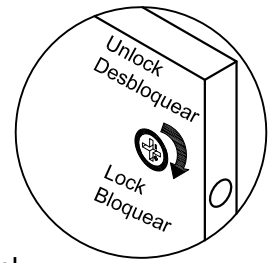

Use one drop of glue in dowel hole.
Use una gota de pegamento en el agujero de clavija.

4

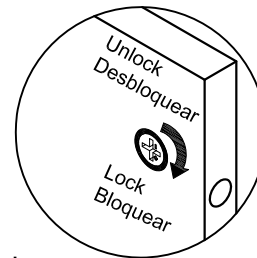
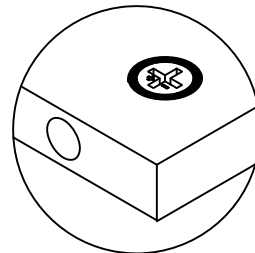
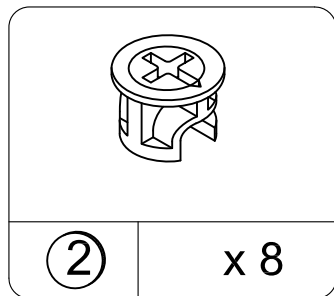
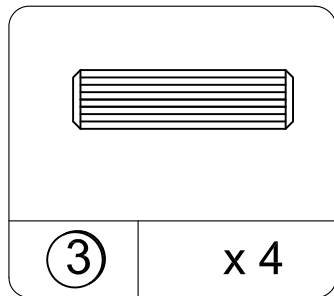
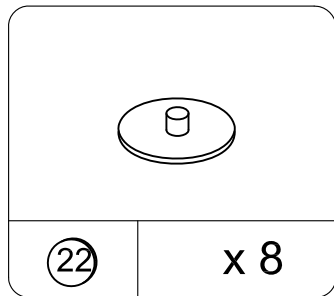
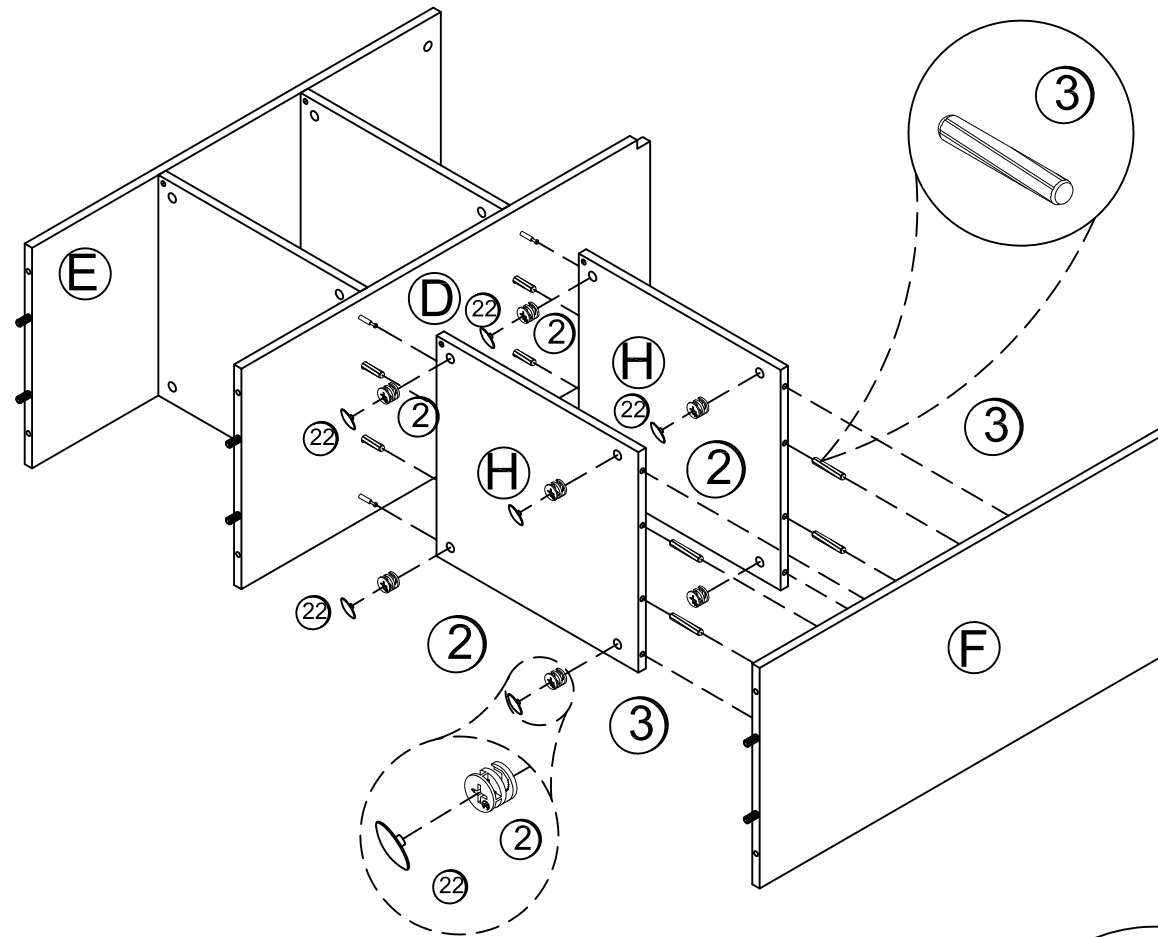

Proper orientation of cam lock
La orientación apropiada para el seguro de bloqueo

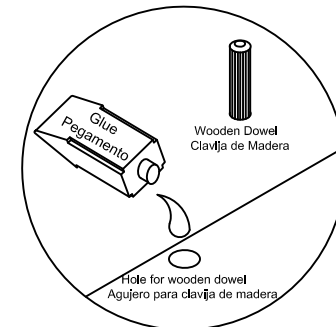

Use one drop of glue in dowel hole.
Use una gota de pegamento en el agujero de clavija.

5

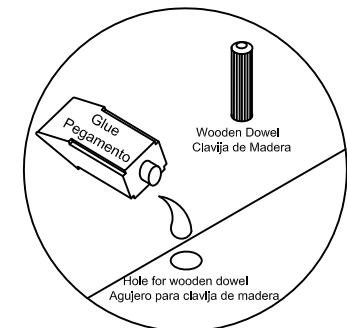
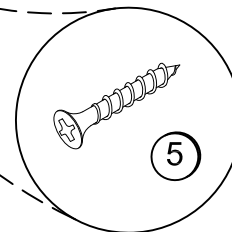
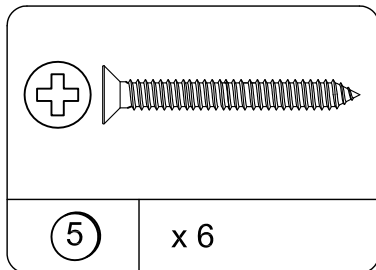
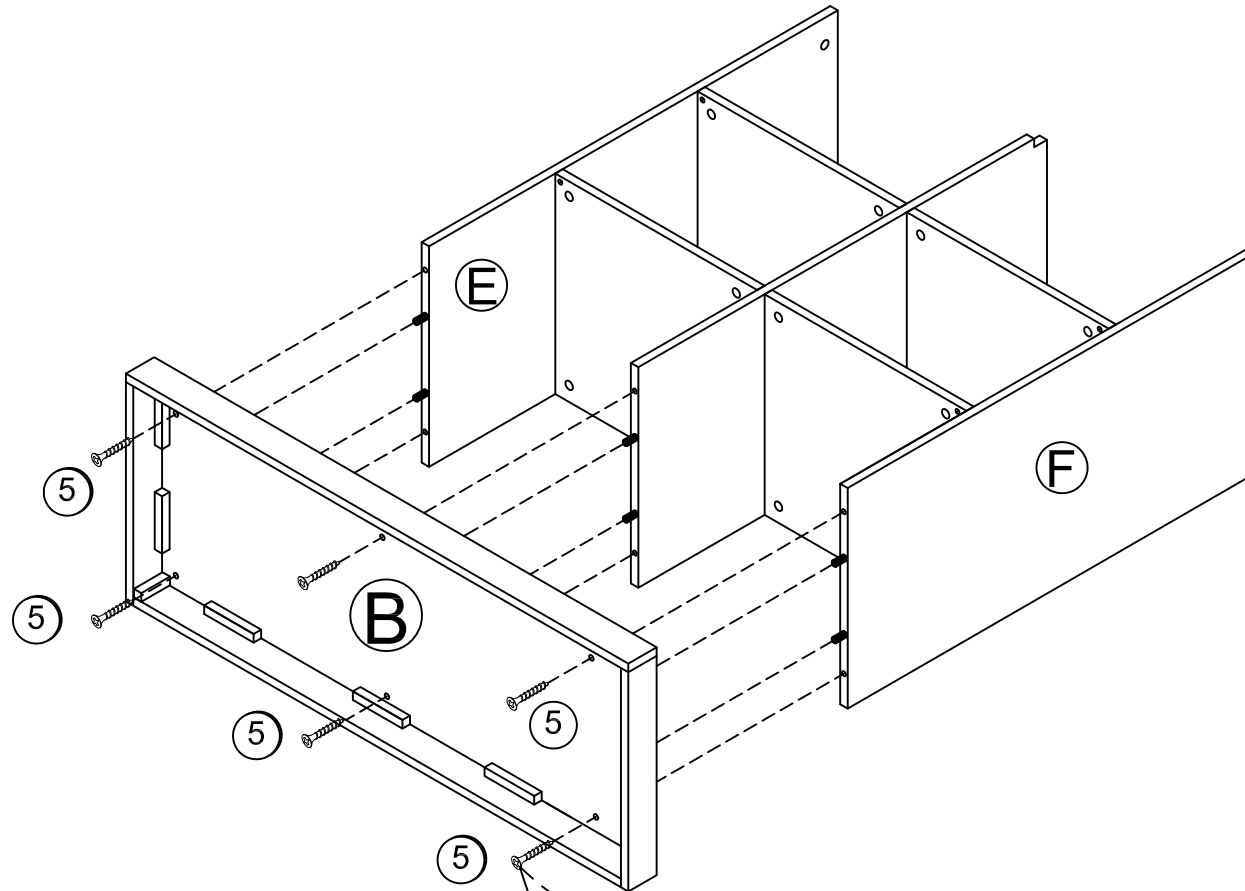

Use one drop of glue in dowel hole.
Use una gota de pegamento en el agujero de clavija.



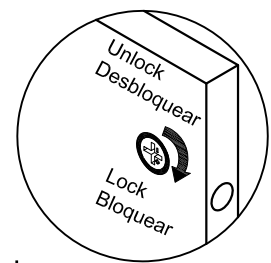
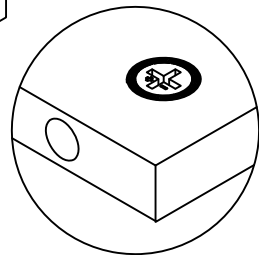
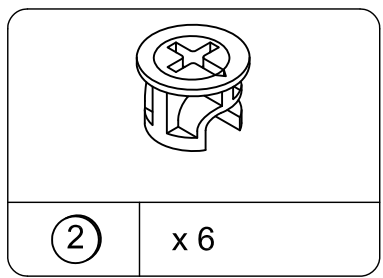
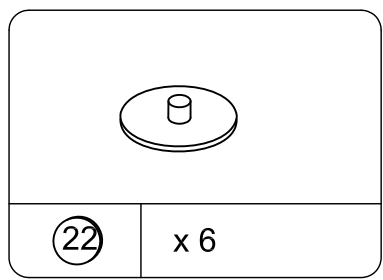
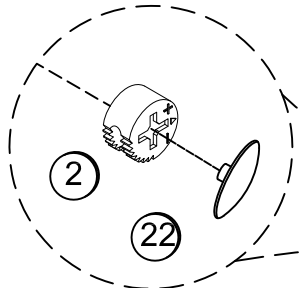
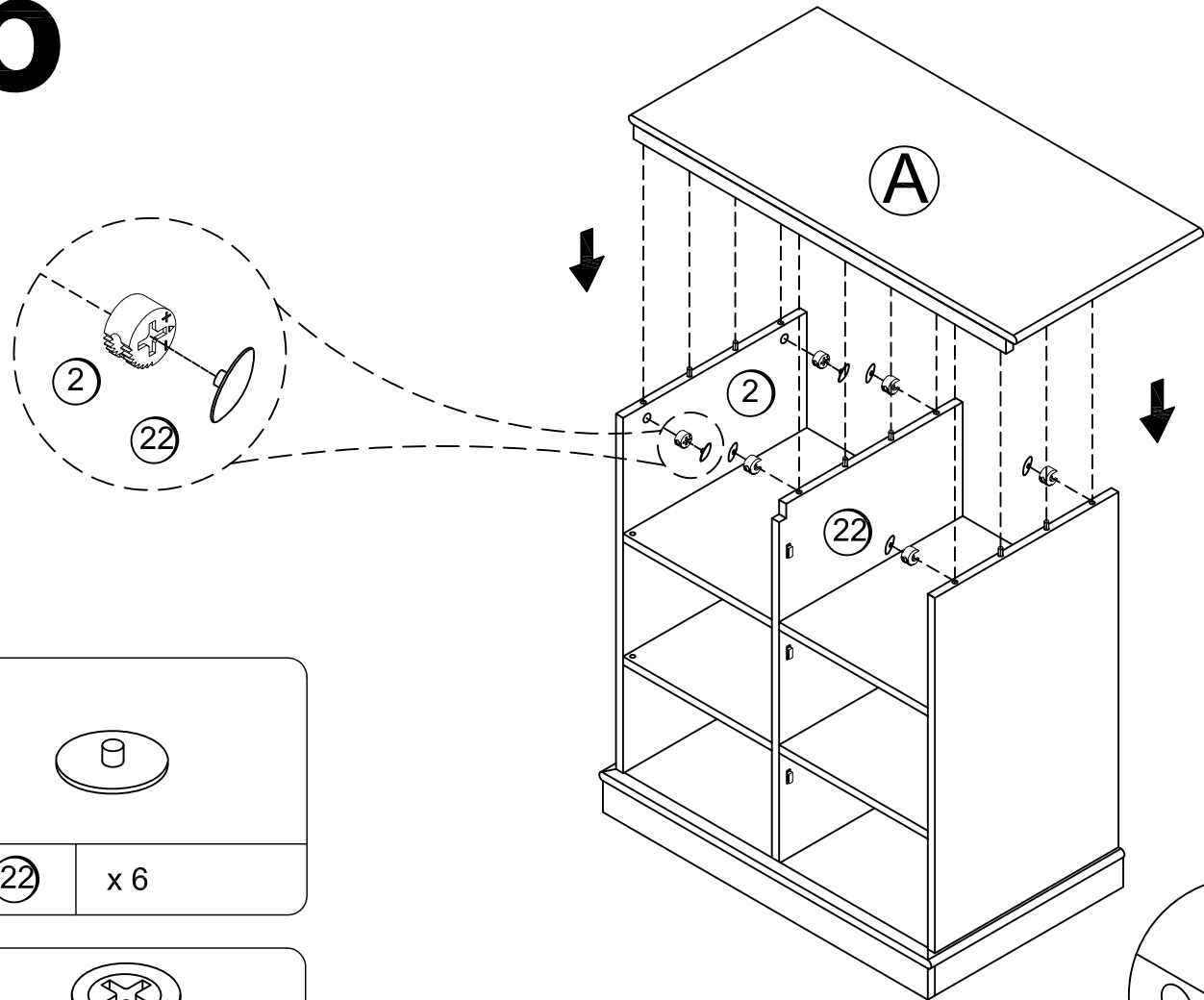







6

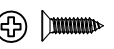

Proper orientation of cam lock
La orientación apropiada para el seguro de bloqueo

7

The knobs (15,16&17) are interchangeable. You can change them if you prefer.
 Los tiradores (15,16&17) son intercambiables. Puede cambiar los si lo prefiere.

	
16 x 1	21 x 7
	
15 x 1	20 x 1
	
14 x 2	19 x 1
	
10 x 6	18 x 1
	
9 x 6	17 x 1

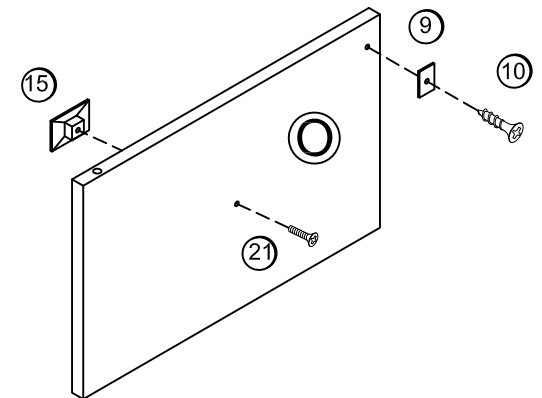
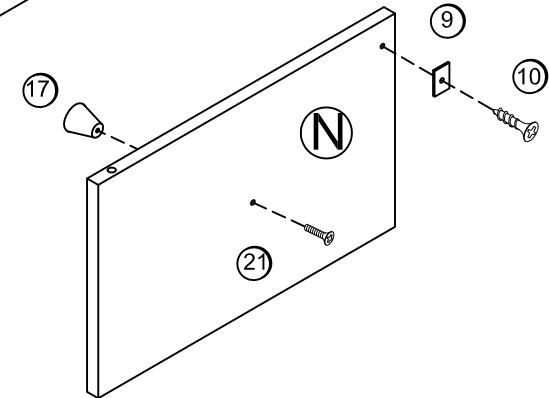
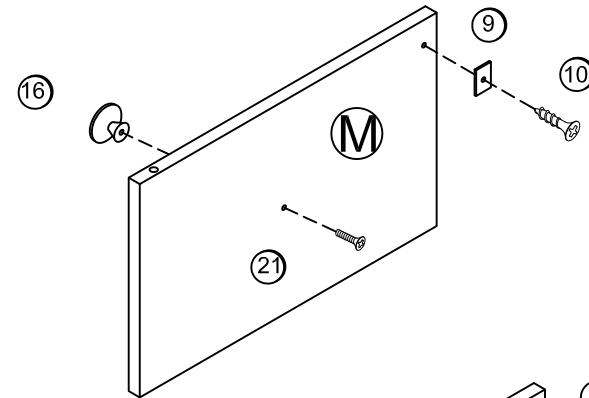
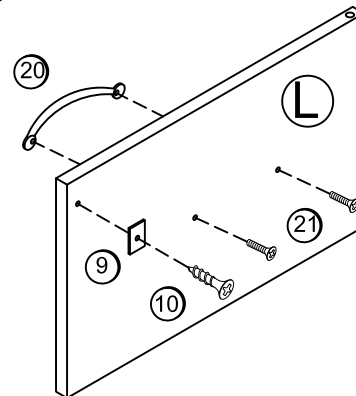
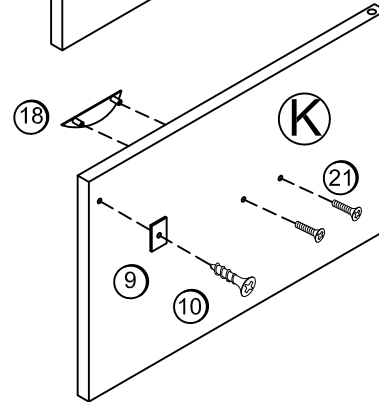
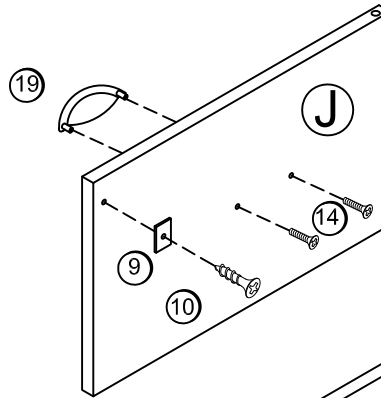

8

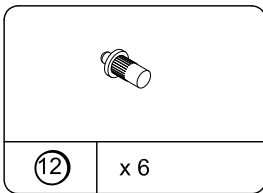
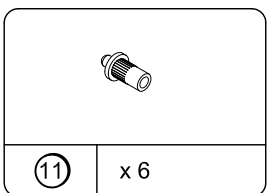
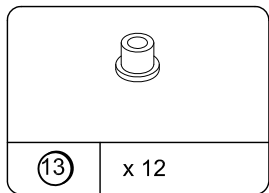
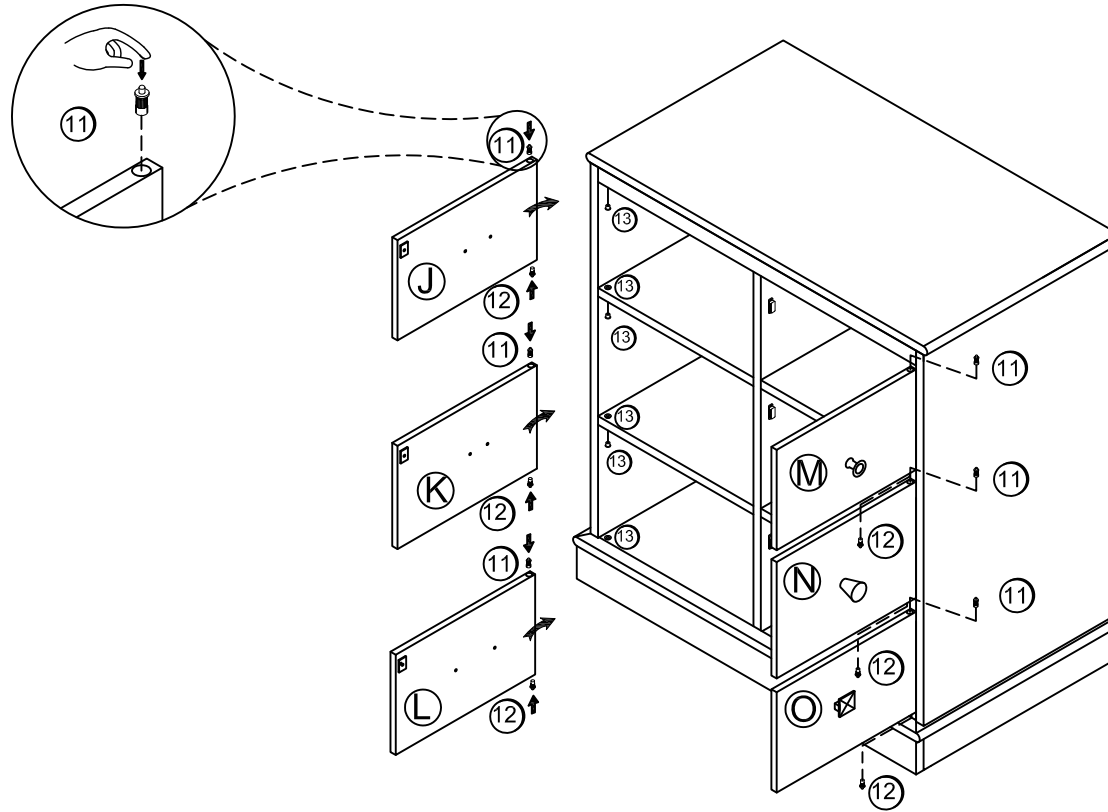

9

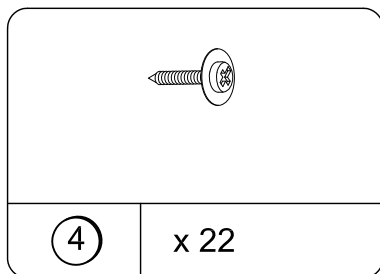
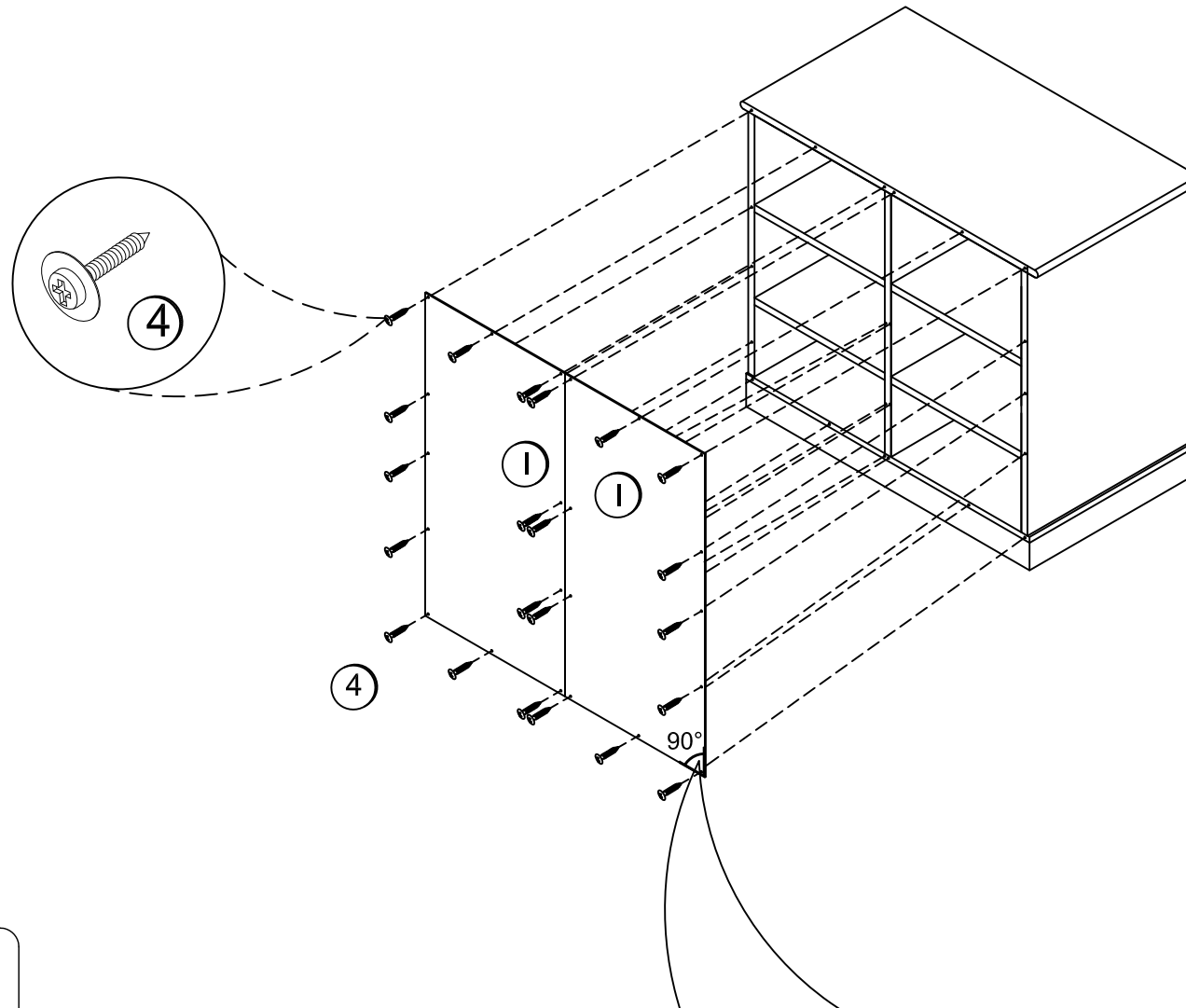

Before attaching the back panel, be sure that the unit is at 90°.
Antes de atar el panel trasero, asegúrese de que la unidad está a 90°.

WEIGHT LIMITS:
LÍMITES DE PESO:

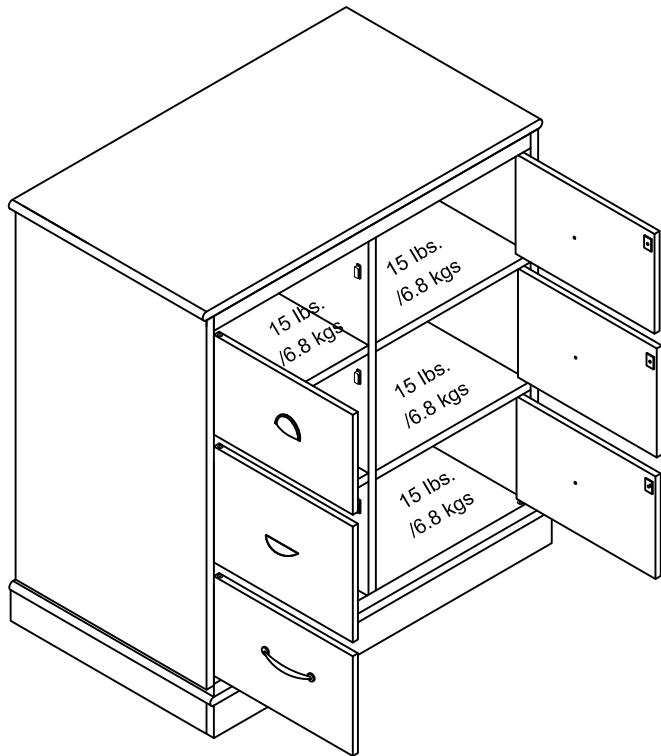

This unit has been designed to support the maximum loads shown. Exceeding these load limits could cause sagging, instability, product collapse, and/or serious injury.

Esta unidad se ha diseñado para apoyar las cargas máximas mostradas. Exceder estos límites de carga podría causar ceder, inestabilidad, derrumbamiento del producto, y lesión seria.

▲ WARNING

Please make sure that all objects are removed before moving the assembled unit.

The unit must be team lifted, not dragged or pushed.

Failure to do so could cause instability, product collapse, and/or serious injury.

▲ ADVERTENCIA

Por favor mueva el mueble cuidadosamente con la ayuda de otra persona. Levante y mueva el mueble a su lugar. No lo arrastre o empuje, de lo contrario puede haber inestabilidad en el mueble y este puede colapsar u ocasionar graves lesiones.

Enjoy Your Furniture
DISFRUTE DE SU MUEBLE