

Instruction Manual

Rain Shower System



6475



6865



6069



6708

Contents

- Installation Condition ----- 1
- 6475/6865 ----- 2
Luxury 3-Function Thermostatic Shower System
- 6069 ----- 7
Luxury 4-Function Thermostatic Shower System
- 6708 ----- 13
Luxury 4-Function Thermostatic LED Shower System
- Care and Maintenance ----- 24

♦ Installation Condition

1. Check the Accessories List to verify that all parts are complete in this package.
2. Do not disassemble the main body by yourself.
3. Connect inlet pipes to supply valves.
4. Make sure inlet pipes and supply valves have been installed and cleaned, with no impurities in the pipeline.
5. After installation, check all joints for leakages.
6. Do not leave the rain shower system exposed to a severely corrosive environment.



YOU MAY NEED:



★ 3 Functions Thermostatic Shower Faucet Set

Model:6475

PRODUCT LIST

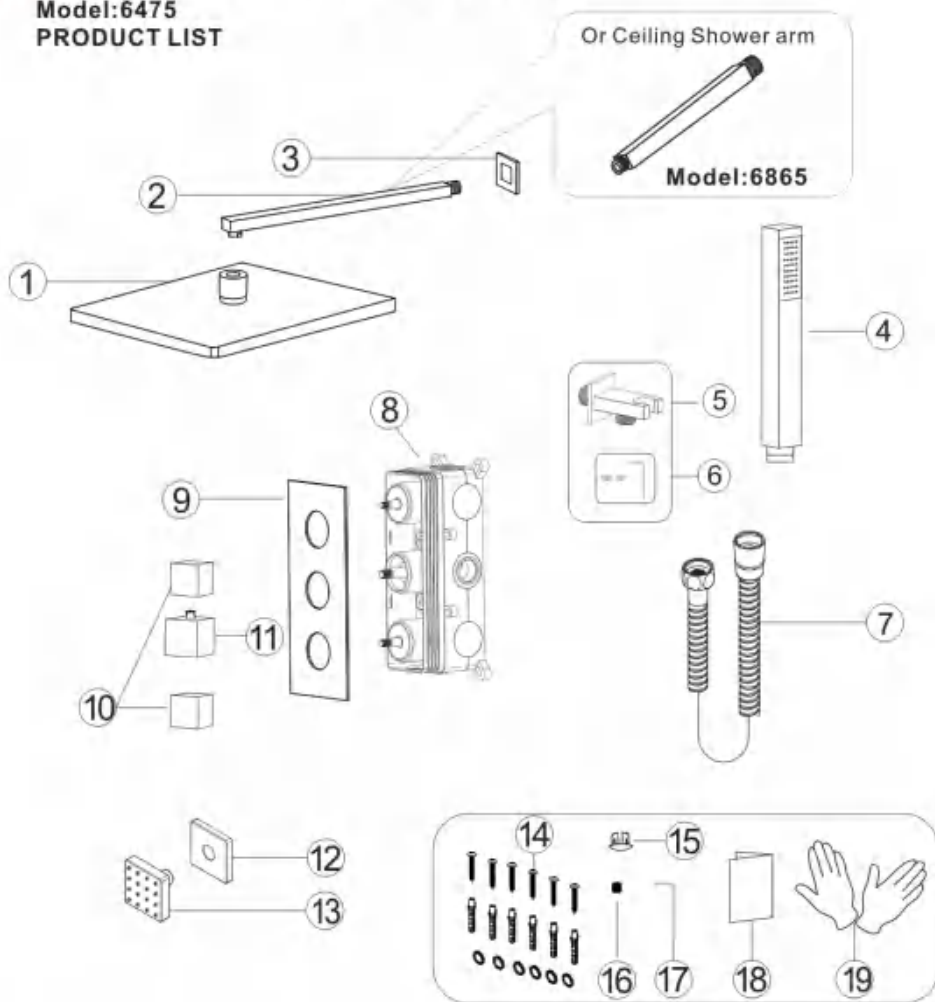

No.	Part name	Qty	No.	Part name	Qty
1	Shower head	1	11	Handle	1
2	Shower arm	1	12	Body jet cup	6
3	Shower arm cup	1	13	Body jet	6
4	Shower hand	1	14	Valve gasket spare parts	4
5	Hand show holer	1	15	Handle cap	1
6	Holder parts	1	16	Screw	1
7	Shower hose	1	17	Wrench	1
8	Main body	1	18	Instruction manual	1
9	Panel	1	19	Gloves	2
10	Water diverter	3			

◆ Essential Dimensions

Step 1

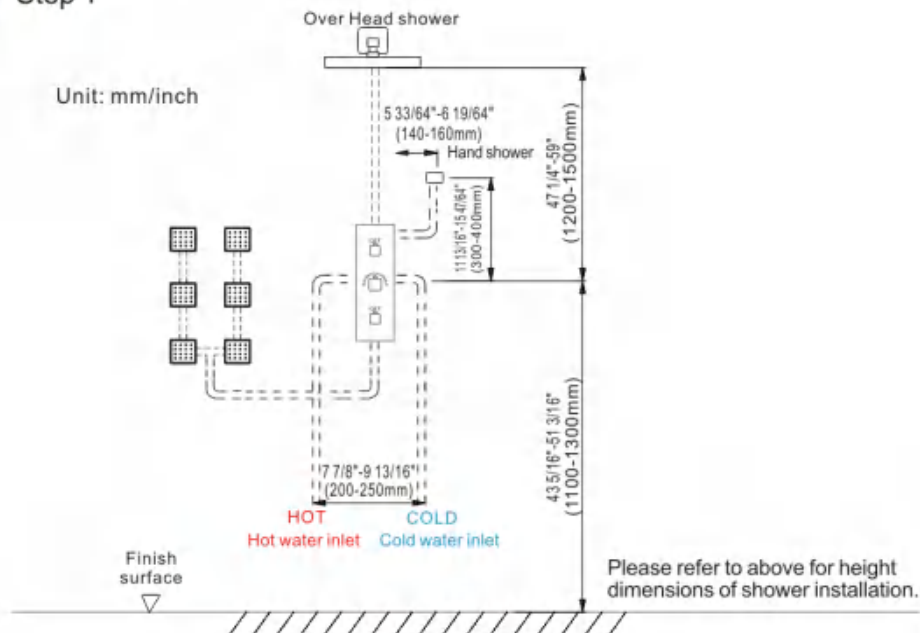

Step 2

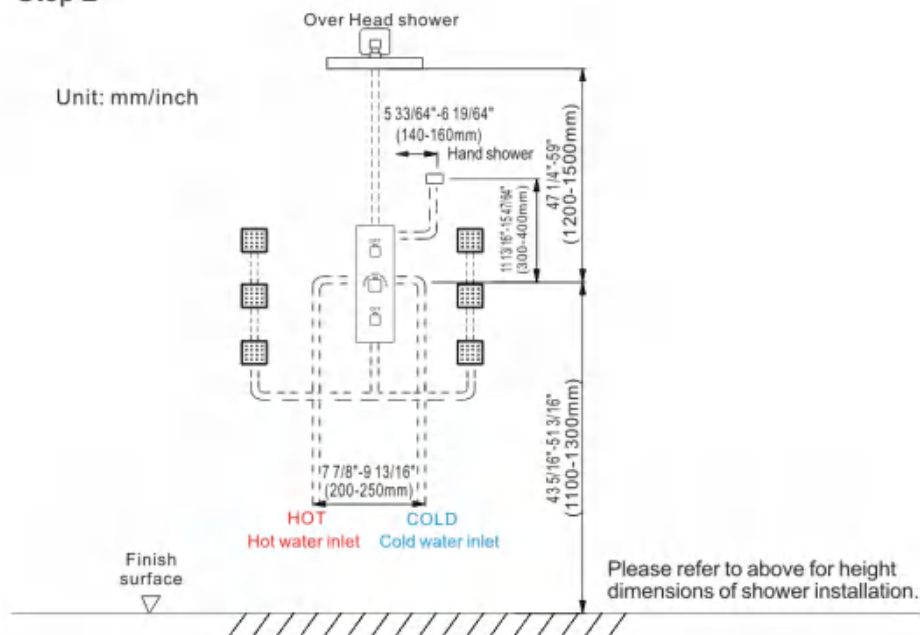

✦ Installation Depth of Shower Holder & Body Jets & Shower Arm

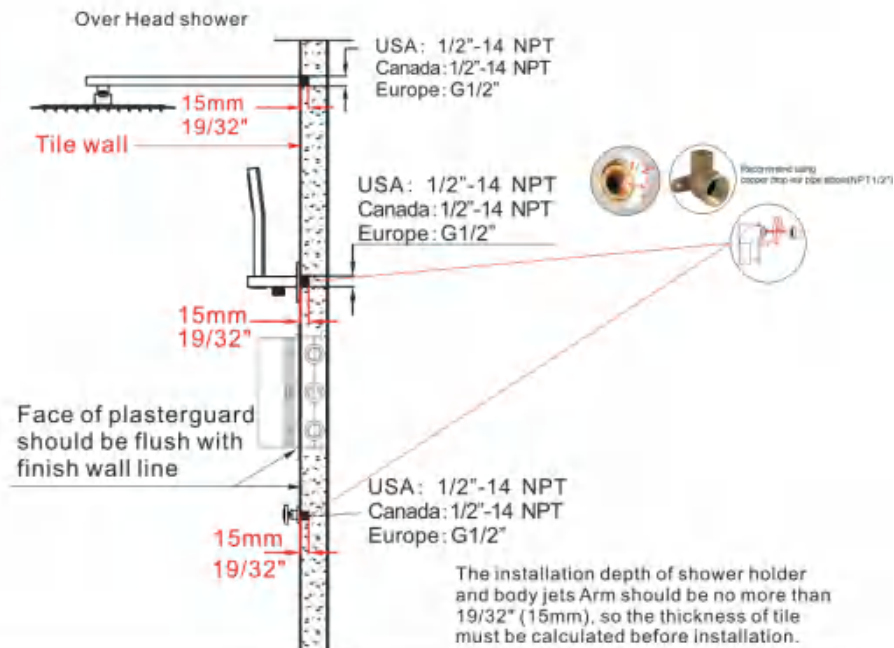

✦ Installation Depth of Main Body

Unit: mm/inch

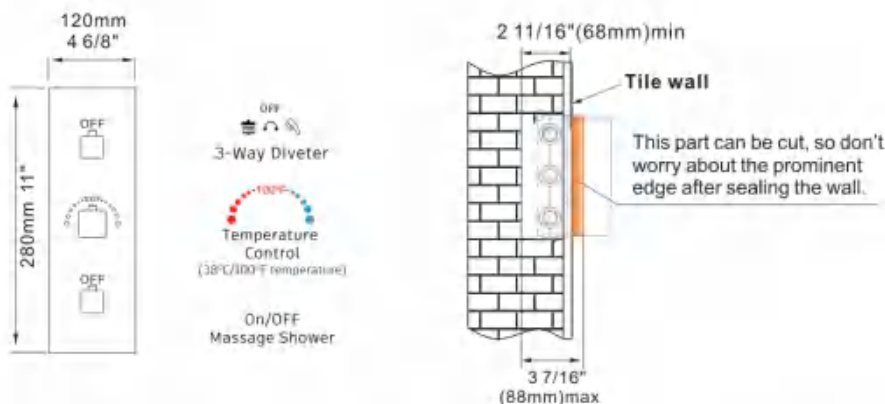

Notice: The installation depth of main body should be no less than 2 11/16" (68mm) and no more than 3 7/16" (88mm), including the thickness of tile, Otherwise, the panel cannot be installed.

• Main Body Connecting Pipe Schematic Diagram



Warning: must install hot water and cold water inlet strictly as instructions.

Wrap enough teflon tape

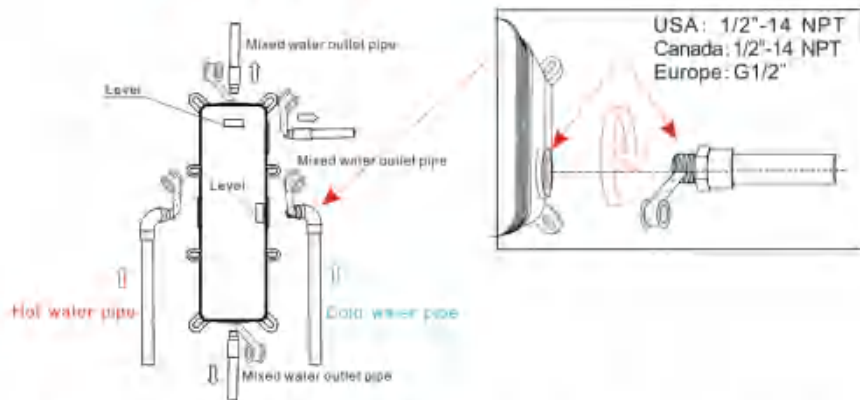

1. As shown in the figure, the inlet and outlet pipes are pre-buried, pay attention to the correct direction of installing the pre-buried main body, and make sure that the mark level on the top of the installation box is facing upward.
2. Install the hot and cold water inlet pipes, Shower head and hand shower holder body jet pipes. Turn on the water source to test whether the left and right inlet pipes are tightly connected without leakage. After the test, adjust the flow switch to be on to test whether the mixed outlet pipe. The connection is tight and there is no leakage.

• Main Body Valve Installation

Precautions for handwheel installation

※1: The red line can't misplace, it should be kept in a line, otherwise the water temperature of 100 F or 38 C will not be correct.



※2: Please ensure that A Plastic locating ring and B handwheel locating pin kept in the same line with 100 F or 38 C. Otherwise, the water temperature will be wrong.

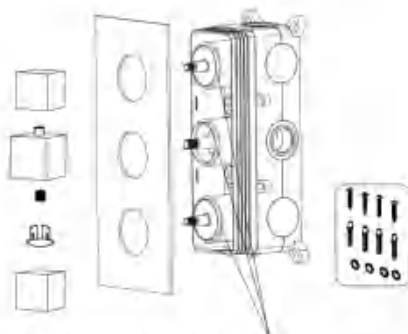

Do not remove the white wear ring otherwise the handwheel will be damaged

Use Valve gasket spare parts and to fixed Main body on the wall and then install Panel, Then use 3pcs screws respectively to install 1pcs hand and 2pcs water separation, and finally install the hand cover.

◆ Installation Of Massage Shower

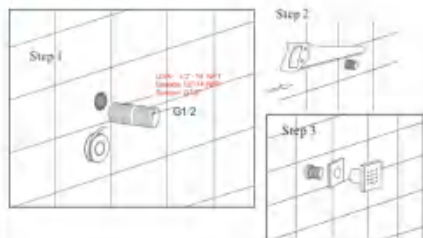

- Step 1. Wrap the threaded pipe of NPT1/2 with Teflon tape and screw it into the wall.
- Step 2. Cut off excess part with a saw.
- Step 3. Put on the decoration cap, then screw the massage shower in.

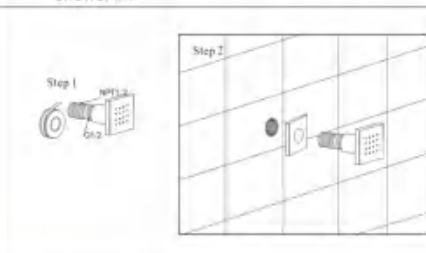

◆ Shower Holder Installation Install The Hand Show Holder

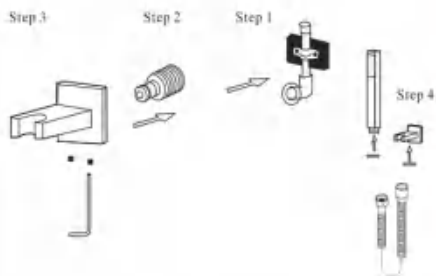

- Step 1. Screw the thread into the water pipe inside the wall.
- Step 2. Screw the main body into the thread.
- Step 3. Rotate and fix the body with the special-shaped wrench.
- Step 4. Connect hand shower and the hose.

◆ Installation Of Rain Shower Head & Shower Arm

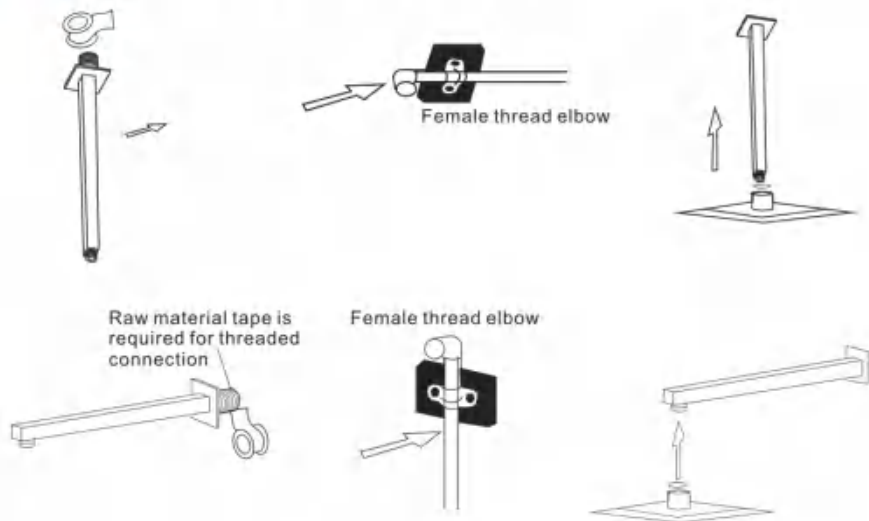

1. Connect shower arm with the cover before screwing arm into riser connection to prevent damage.
2. Fix shower head onto shower arm and apply tape to pipe threads on both ends.
3. Do not overtighten shower head. It is 360° swivel connection.

★ **Luxury 4-Function Thermostatic Shower System**

Model:6069

PRODUCT LIST

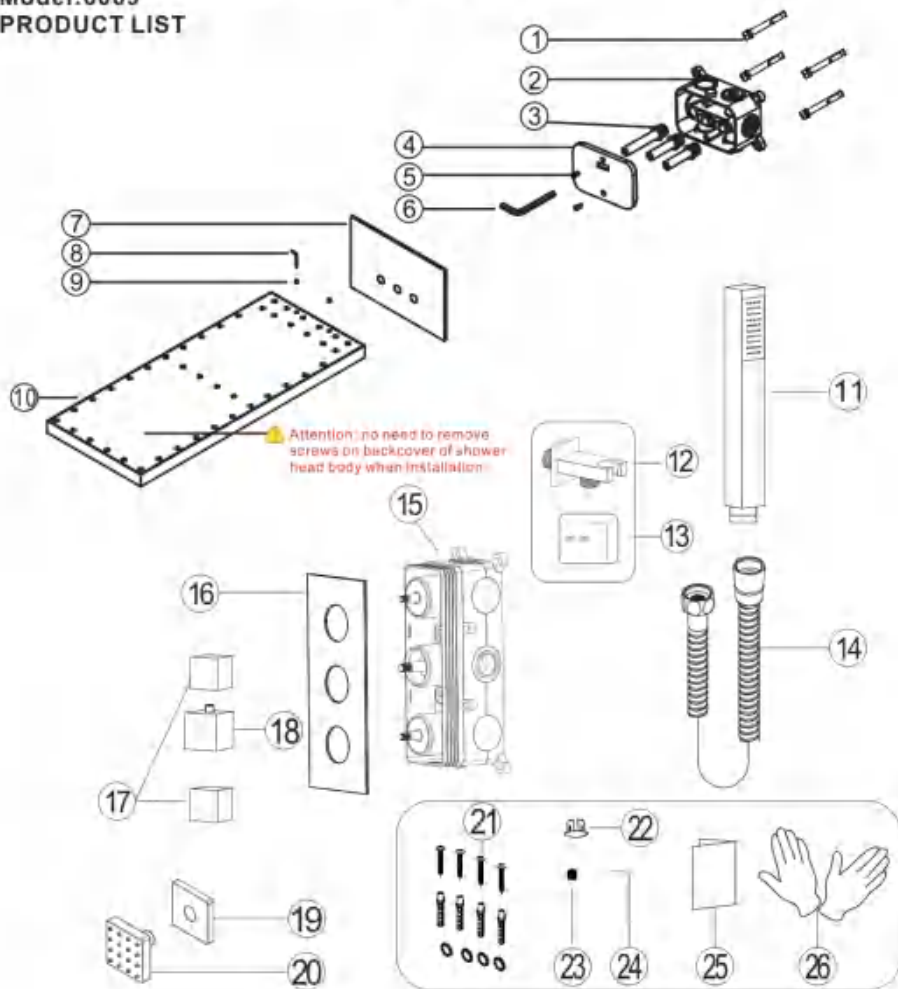

No.	Part name	Qty	No.	Part name	Qty	No.	Part name	Qty
1	Expansion screws	4	10	Shower head body	1	19	Body jet cup	6
2	Inwall box	1	11	Shower hand	1	20	Body jet	6
3	Waterinlet	3	12	Hand show holer	1	21	Valve gasket spare parts	4
4	Cover	1	13	Holder parts	1	22	Handle cap	1
5	Screw	2	14	Shower hose	1	23	Screw	1
6	S8 Allen key	1	15	Main body	1	24	Wrench	1
7	Flange	1	16	Panel	1	25	Instruction manual	1
8	Allen key 2.5	1	17	Water diverter	2	26	Gloves	2
9	M4 screw	2	18	Handle	1			

♦ Essential Dimensions

Step 1

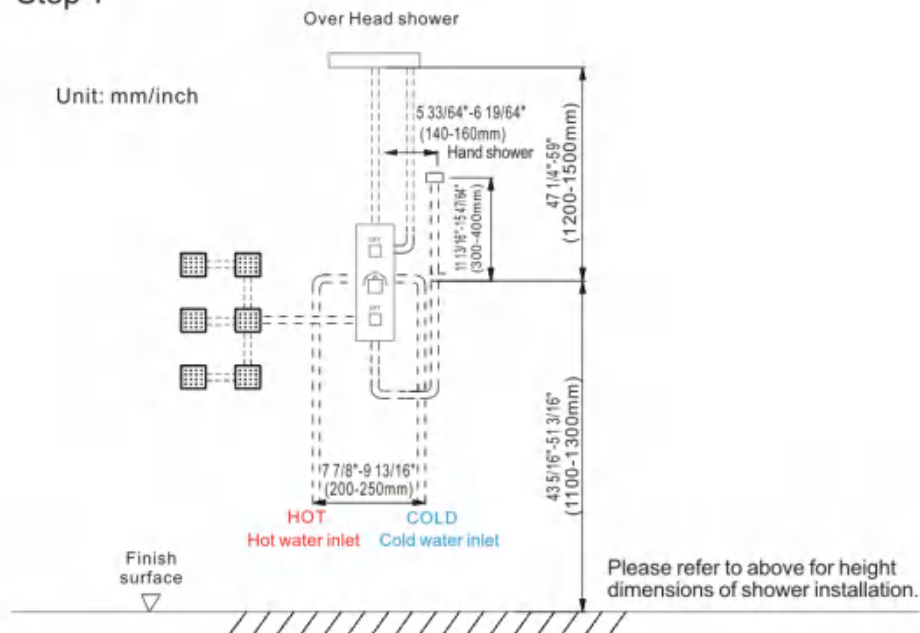

Step 2

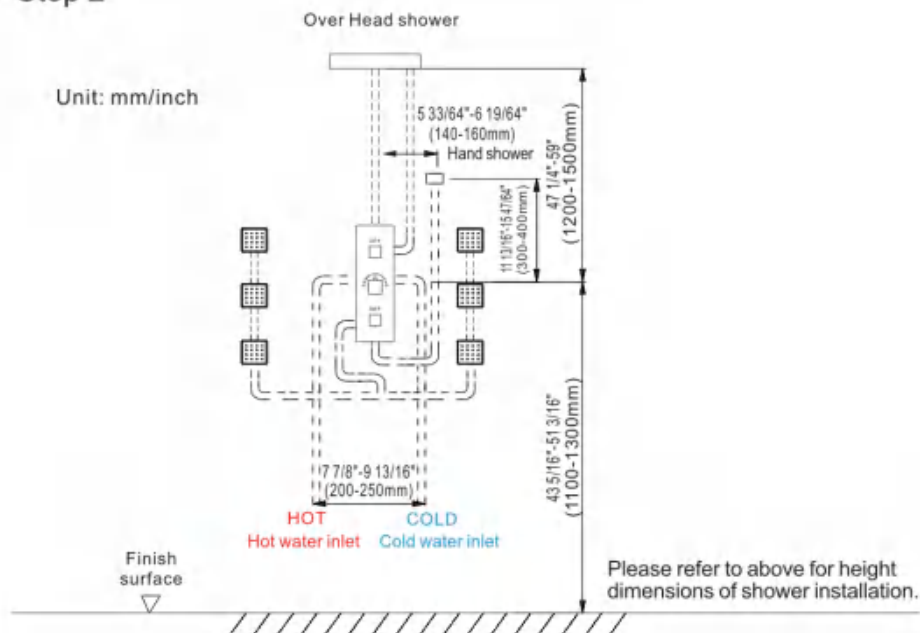

◆ Installation Depth of Shower Holder & Body Jets

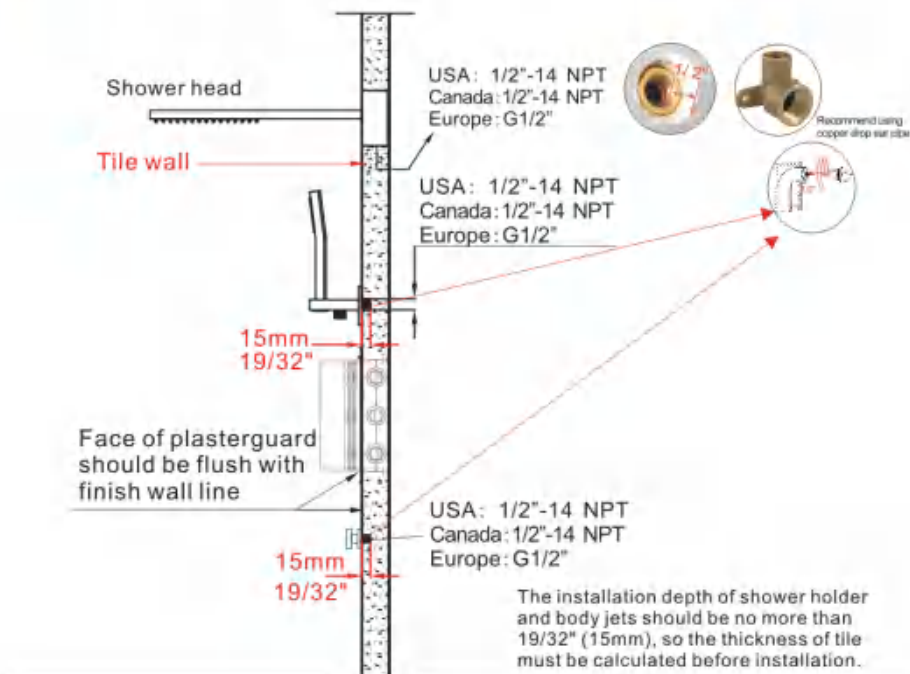

◆ Installation Depth of Main Body

Unit: mm/inch

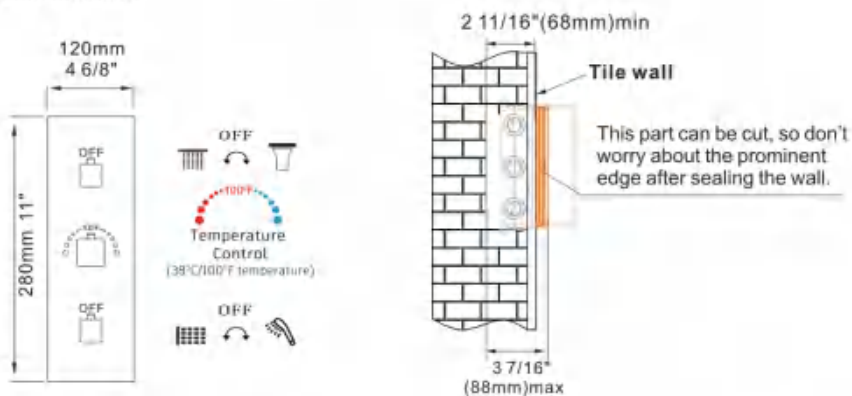

Notice: The installation depth of main body should be no less than 2 11/16" (68mm) and no more than 3 7/16" (88mm), including the thickness of tile, Otherwise, the panel cannot be installed.

★ MAIN BODY CONNECTING PIPE SCHEMATIC DIAGRAM

! Warning: must install hot water and cold water inlet strictly as instructions.

Wrap enough teflon tape

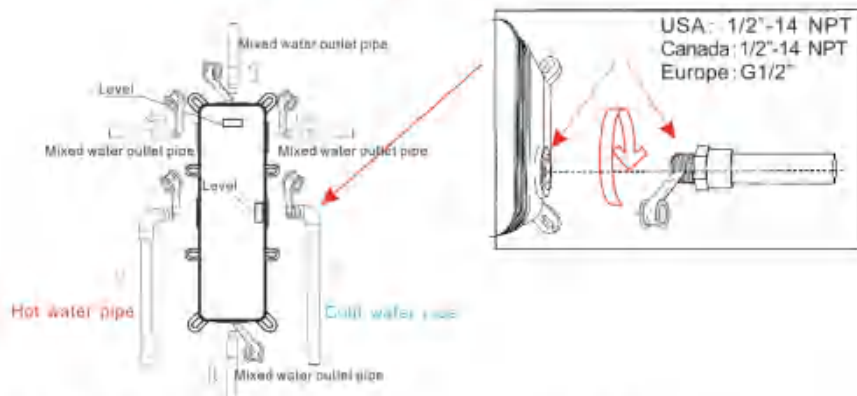

1. As shown in the figure, the inlet and outlet pipes are pre-buried, pay attention to the correct direction of installing the pre-buried main body, and make sure that the mark level on the top of the installation box is facing upward.
2. Install the hot and cold water inlet pipes, Shower head and hand shower holder body jet pipes. Turn on the water source to test whether the left and right inlet pipes are tightly connected without leakage. After the test, adjust the flow switch to be on to test whether the mixed outlet pipe. The connection is tight and there is no leakage.

★ MAIN BODY VALVE INSTALLATION

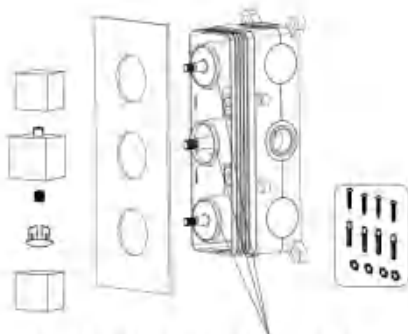

Do not remove the white wear ring otherwise the handwheel will be damaged

Precautions for handwheel installation

※1: The red line can't misplace, it should be kept in a line, otherwise the water temperature of 100 F or 38 C will not be correct.



※2: Please ensure that A Plastic locating ring and B handwheel locating pin kept in the same line with 100 F or 38 C. Otherwise, the water temperature will be wrong.



Use Valve gasket spare parts and to fixed Main body on the wall and then install Panel, Then use 3pcs screws respectively to install 1pcs hand and 2pcs water separation, and finally install the hand cover.

Model: 6069 22in Shower Head Installation

1. Digging wall according to following size, and connect rain and waterfall inlet correctly

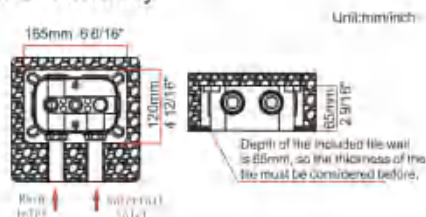

⚠ If the Inwall box is embedded too deep, the shower head will not be installed properly and it will cause water leakage and sag problems. Please pay special attention to the installation depth.

2. Lock Inwall box refer to level meter guarantee horizontal level and test leaking for 24 hours.

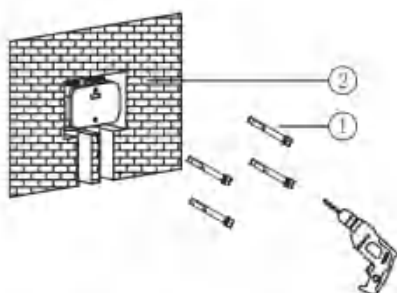

3. Remain inwall box in same level as wall after seal the tile and cover exceed wall.

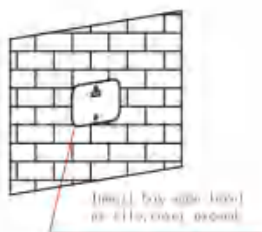

4. Install Shower head body. First remove box cover and plug, screw three water inlets into inwall box with S8 Allen Key. Longest role is support.

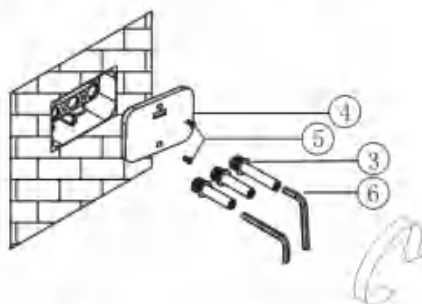

5. Install Flange as picture. Caution: do setp 4-5-6 to test horizontal and vertical position of shower head before wall seal to avoid any trouble of repair after wall seal.

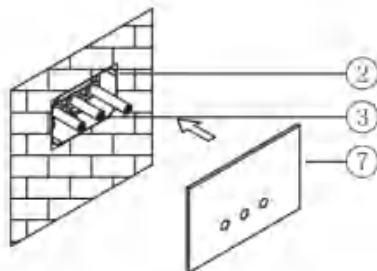

6. Push shower head body into according water inlets, and tighten shower body by M4 screw with Allen key 2.5.

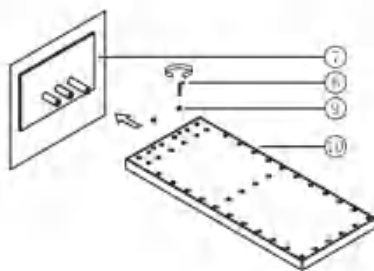

◆ Installation Of Massage Shower

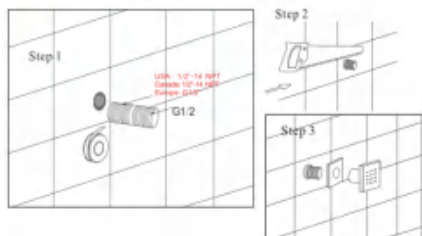

Step 1. Wrap the threaded pipe of NPT1/2 with Teflon tape and screw it into the wall.

Step 2. Cut off excess part with a saw.

Step 3. Put on the decoration cap, then screw the massage shower in.

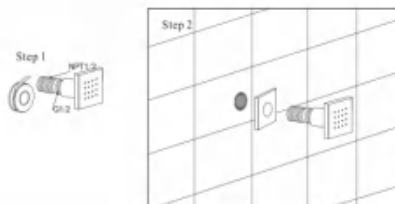

◆ Shower Holder Installation Install The Hand Show Holder

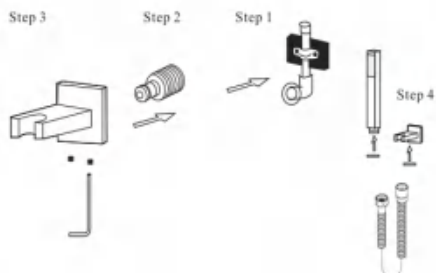

Step 1. Screw the thread into the water pipe inside the wall.

Step 2. Screw the main body into the thread.

Step 3. Rotate and fix the body with the special-shaped wrench.

Step 4. Connect hand shower and the hose.

• Luxury 4-Function Thermostatic LED Shower System

Model 6708

PRODUCT LIST

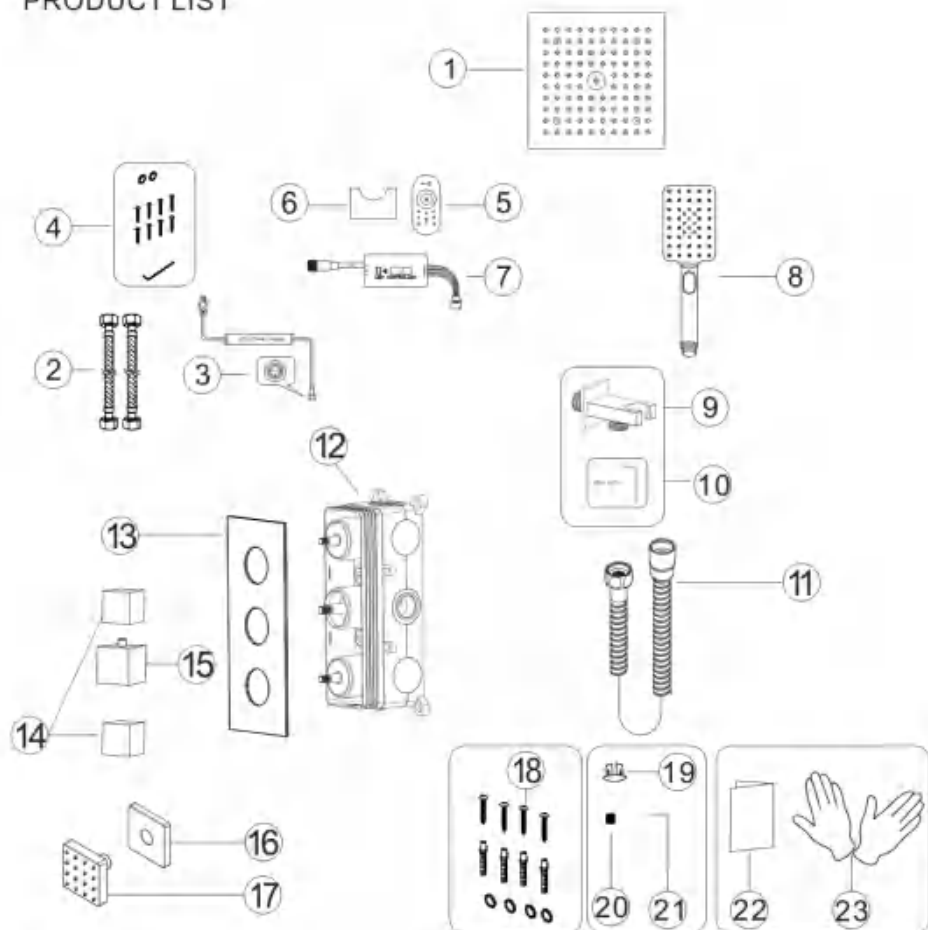

No.	Part name	Qty	No.	Part name	Qty	No.	Part name	Qty
1	Shower head body	1	11	Shower hose	1	21	Handle wrench	1
2	Corrugated pipe	2	12	Main body	1	22	Instruction Manual	1
3	Water proof power supply	1	13	Panel	1	23	Gloves	2
4	Shower head parts	1set	14	Water diverter	2			
5	LED controller	1	15	Handle	1			
6	Controller pedestal	1	16	Body jet	6			
7	Wifi controller	1	17	Body jet cup	6			
8	Hand shower	1	18	Body box fittings	4set			
9	Hand shower holder	1	19	Handle cap	1			
10	Holder spare parts	1	20	Handle screw	1			

♦ Essential Dimensions

Step 1

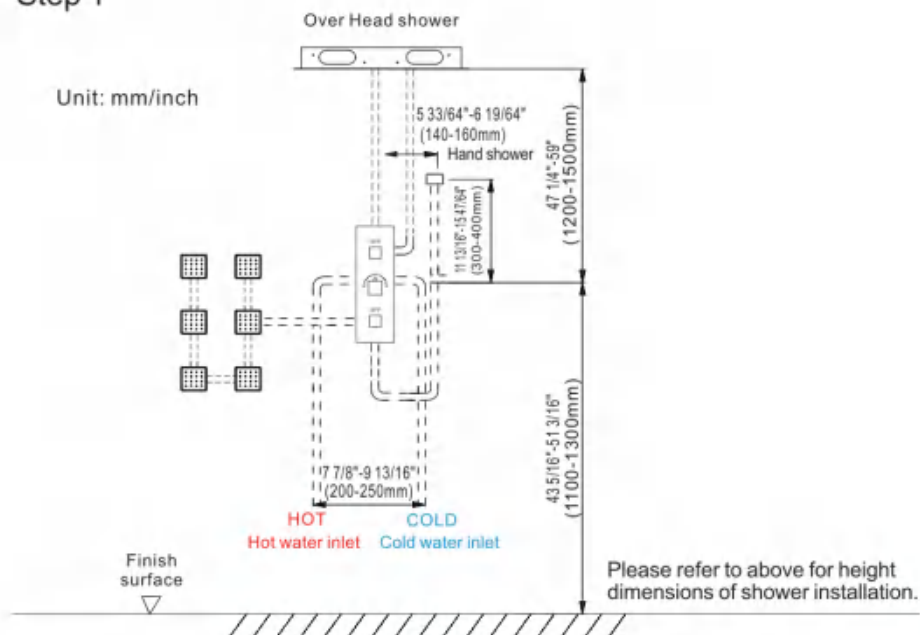

Step 2

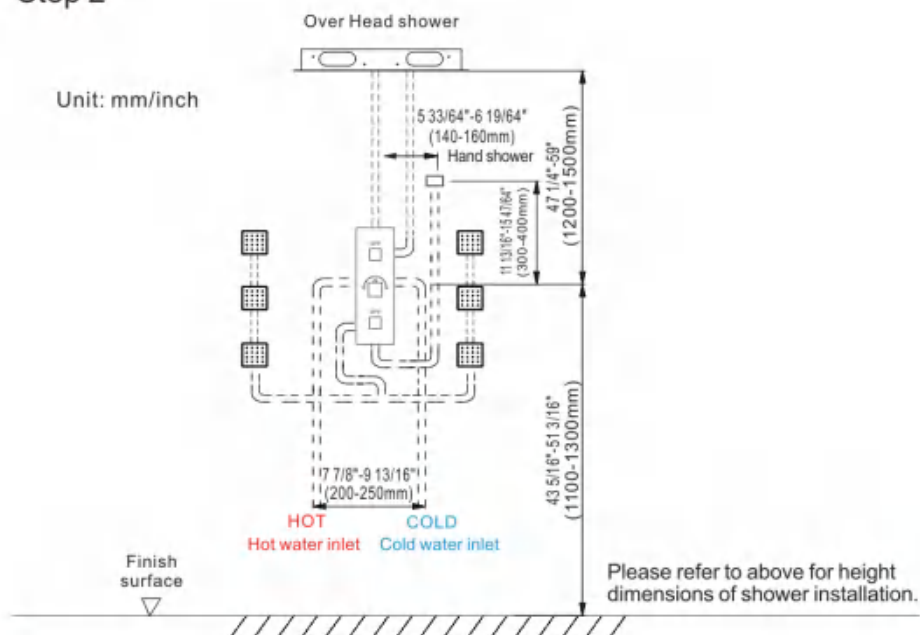

• Installation Depth of Shower Holder & Body Jets

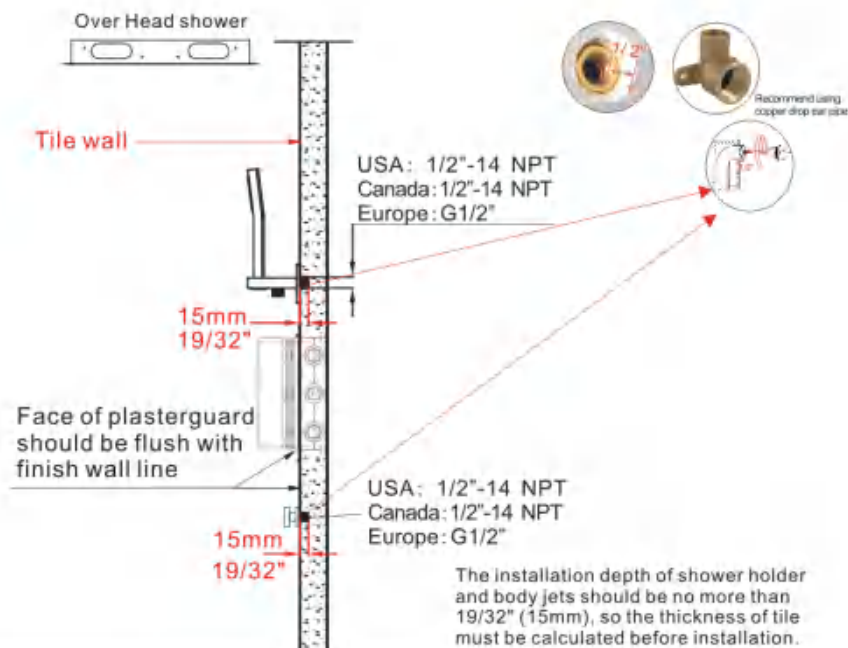

• Installation Depth of Main Body

Unit: mm/inch

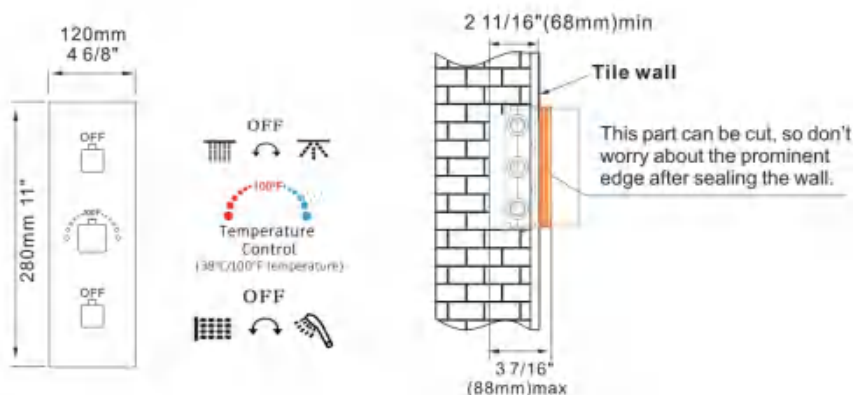

Notice: The installation depth of main body should be no less than 2 11/16" (68mm) and no more than 3 7/16" (88mm), including the thickness of tile, otherwise, the panel cannot be installed.

★ MAIN BODY CONNECTING PIPE SCHEMATIC DIAGRAM

! Warning: must install hot water and cold water inlet strictly as instructions.

Wrap enough teflon tape

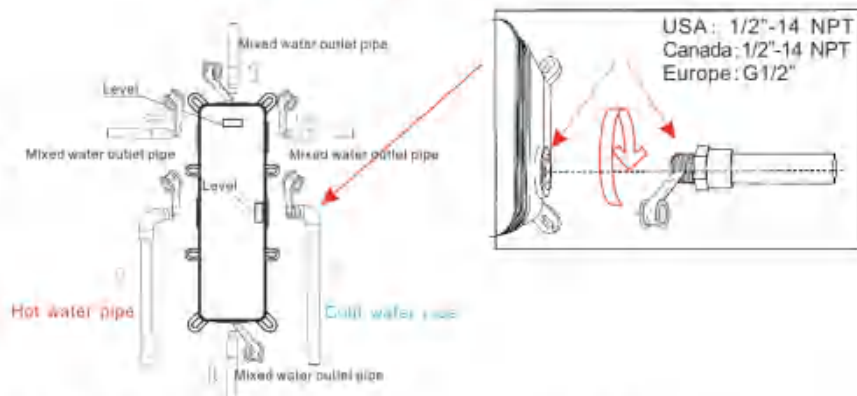

1. As shown in the figure, the inlet and outlet pipes are pre-buried, pay attention to the correct direction of installing the pre-buried main body, and make sure that the mark level on the top of the installation box is facing upward.
2. Install the hot and cold water inlet pipes, Shower head and hand shower holder body jet pipes. Turn on the water source to test whether the left and right inlet pipes are tightly connected without leakage. After the test, adjust the flow switch to be on to test whether the mixed outlet pipe. The connection is tight and there is no leakage.

★ MAIN BODY VALVE INSTALLATION

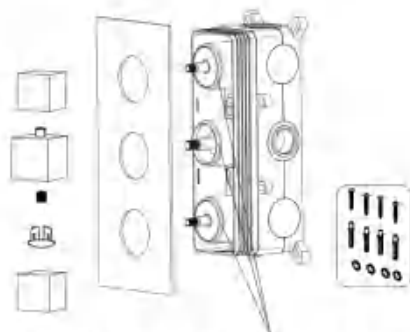

Do not remove the white wear ring otherwise the handwheel will be damaged

Precautions for handwheel installation

※1: The red line can't misplace, it should be kept in a line, otherwise the water temperature of 100 F or 38 C will not be correct.



※2: Please ensure that A Plastic locating ring and B handwheel locating pin kept in the same line with 100 F or 38 C. Otherwise, the water temperature will be wrong.

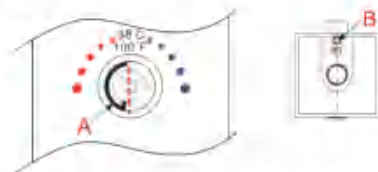

Use Valve gasket spare parts and to fixed Main body on the wall and then install Panel, Then use 3pcs screws respectively to install 1pcs hand and 2pcs water separation, and finally install the hand cover.

◆ Plumbing Layout of Shower Head

◆ Holes on Ceiling

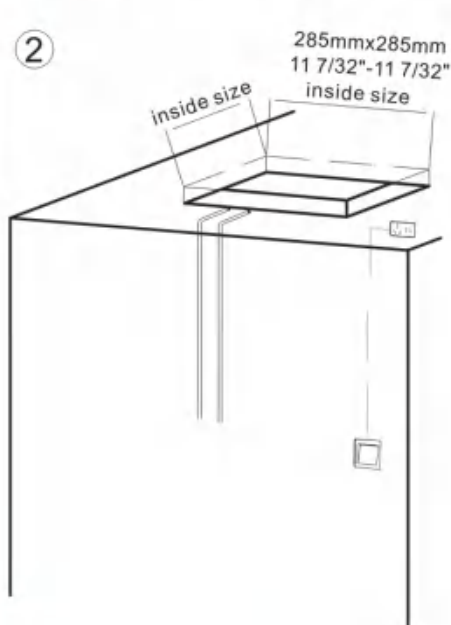
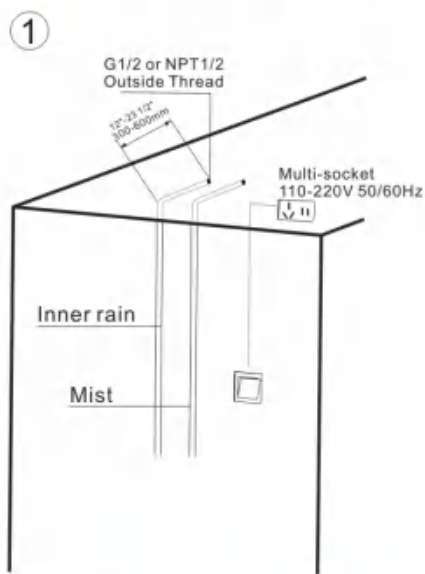

Install the power switch in the appropriate position, lay out water pipeline and connect it to the main body.

◆ Shower Head Exploded View

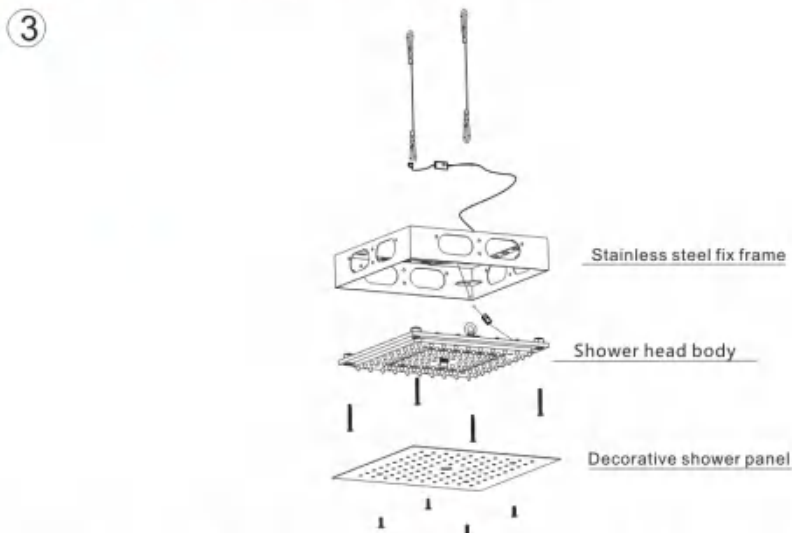

According to the mark (Remove Install) on the top of shower head panel, respectively unscrew the decorative shower panel, shower head body and fix frame.

◆ Fix Frame Installation

④

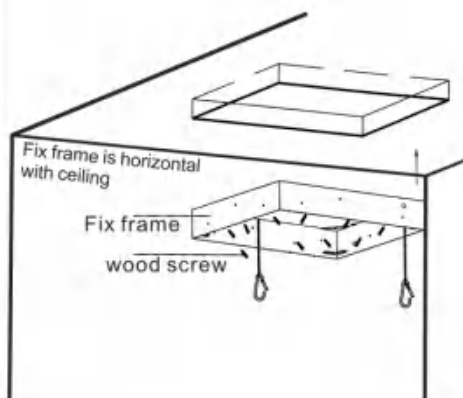

Fasten the fix frame to the wooden frame with 8 screws.

◆ Layout for Power

⑤

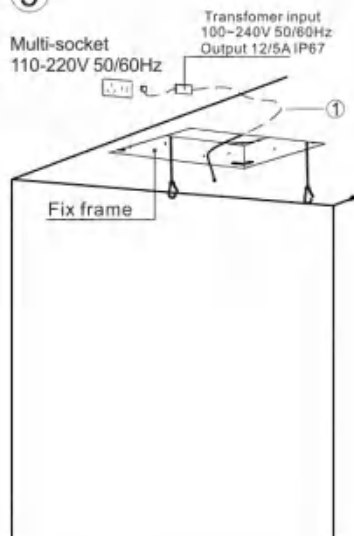

◆ Shower Head Body Installation

⑥

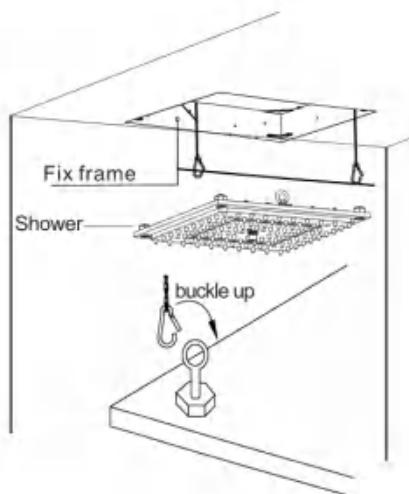

◆ Layout for Water Pipe

⑦

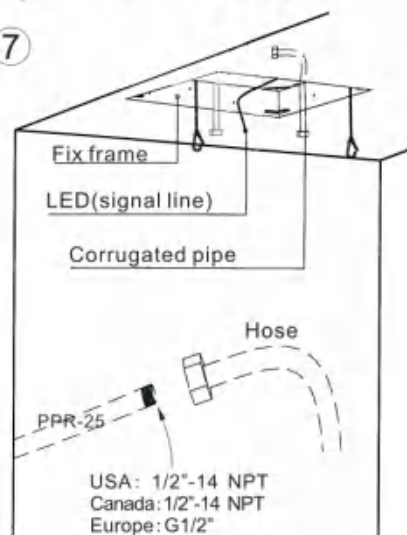

Connect one end of the corrugated pipe to the embedded PPR water pipe and the other end to the water inlet pipe on the back of shower head.

◆ Water Inlet Pipe Connection

8

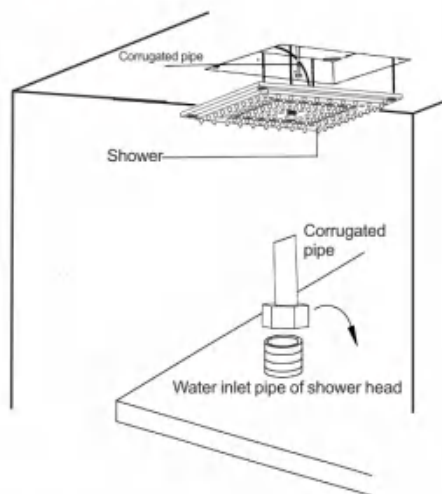

◆ LED (Single Line) Connection

9

- ① to ① wifi controuer wrap it with adhesive tape to prevent it from falling off.
- ② to ② connect the Power supply and WiFi.
- ③ to ③ connect the Power supply and sound.

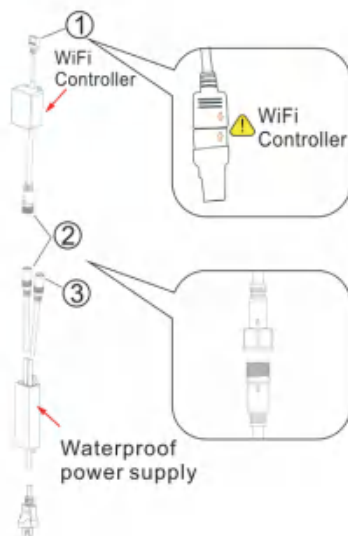
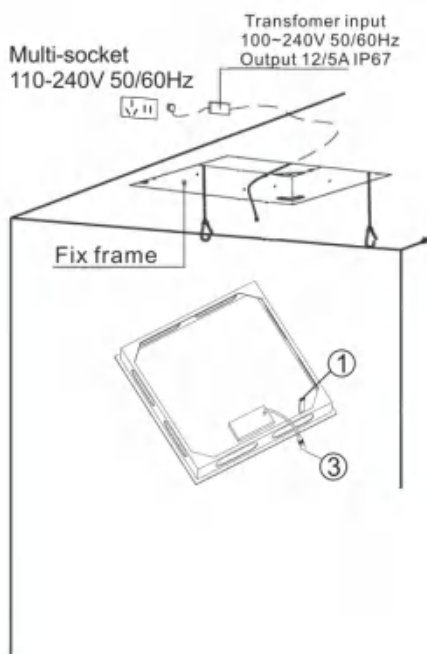

◆ LED (Single Line) Connection

10

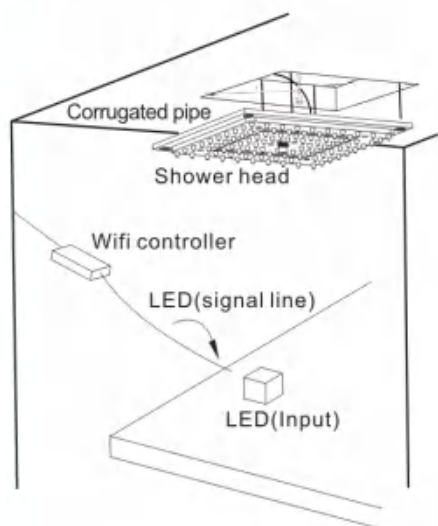

◆ Water Testing

11

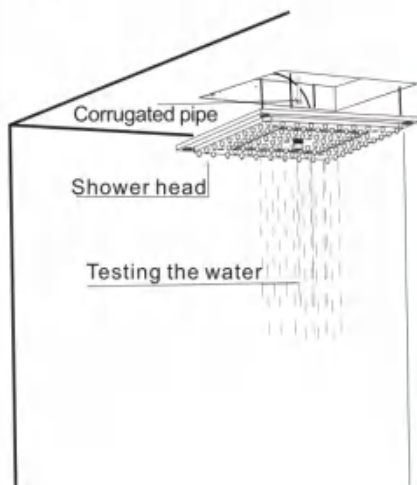

◆ Shower Head Installation

12

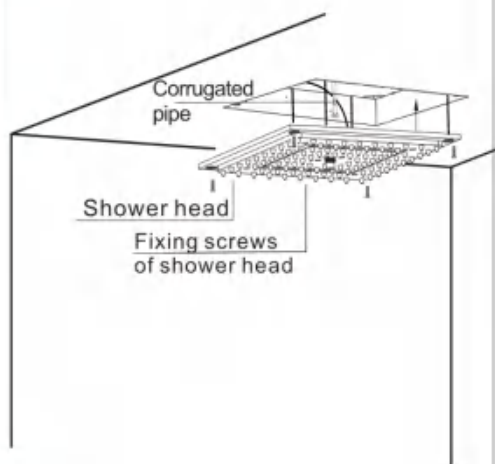

◆ Decorative Shower Panel Installation

13

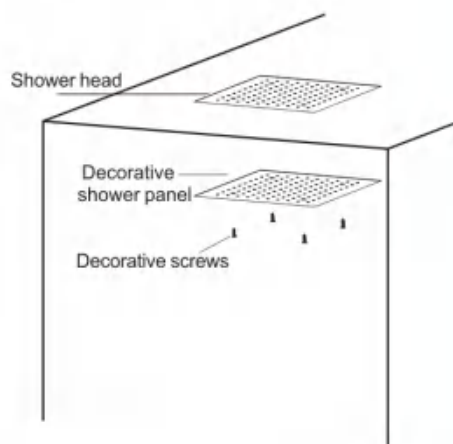

◆ Touch Remote Instruction

Main parameter:

Panel controller:

Working Temp.: -20~60°C

Supply Voltage: DC12-24V

Size: L50*W35*H23mm

1 15/16" * 1 6/16" * 14/16"

Output: 3 channels

Output Current: <2A (each channel)

Connection mode: common anode

Touch Remote:

Working voltage: 1.5V*3V

Emission current: 10mA

Working Current: 300uA

Standby Current: 3uA

Standby time: 6 months

Control Distance: 20M

Color pulley point: 60



Touch remote has 9 touch keys, with each functioning as follows:

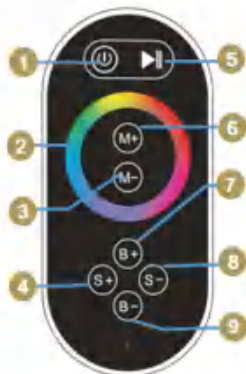

- ① Turn ON/OFF
- ⑤ Mode Switch
- ② Color Touch Ring
- ③/⑥ Color Temperature adjusting
- ④/⑧ Dynamic Speed adjusting
- ⑦/⑨ Dynamic Brightness adjusting

2. Power supply management:

The remote will enter the standby state (untouchable state) when pressed for more than 20s. If it happens, please slightly shake it once and then the remote will come back to the normal working state (touchable state).

3. Indicator light instruction:

3.1. The remote is idle or sending signal when the PWR is bright; when the PWR is off, it will enter the standby state.

3.2. When RF is bright, it means the remote is sending signal; off means there is no signal sending.

Mode:

NO.	FUNCTION	REMOTE
1	Static red	Brightness is adjustable Speed is unadjustable
2	Static green	
3	Static blue	
4	Static purple	
5	Static blue-green	
6	Static yellow	
7	Static white	
8	R G B Jumping	Brightness is adjustable Speed is adjustable
9	R G B Gradual	
10	7-Colors Jumping	
11	7-Colors Gradual	

Controller connections shown:



Remarks:

1. This product should be commissioned and installed by qualified personnel.
2. This product can not be waterproof, need to avoid sun and rain, if installed outdoors, please use waterproof box.
3. Good heat dissipation conditions will extend the life of the LED controller, please install the product in a well-ventilated environment.
4. Please do not install or use such products in lightning, thunder, strong magnetic or high voltage applications.
5. Please check whether the output voltage of the LED power supply used meets the product voltage range requirements.
6. The diameter of the wire used must be sufficient to load the connected LED luminaire, and ensure that the wiring is firm, to avoid the wire overheating or poor contact triggers the accident.
7. Before power-on debugging, ensure that all wiring is correct to avoid damage to the luminaire due to wiring errors.

◆ Body Jets Installation

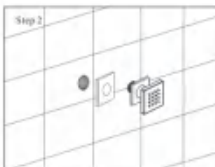
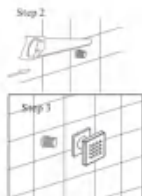

- Step 1. Wrap the threaded pipe of NPT1/2 with Teflon tape and screw it into the wall.
Step 2. Cut off excess part with a saw.
Step 3. Screw the massage body jet onto the wall.

◆ Hand Shower Holder Installation

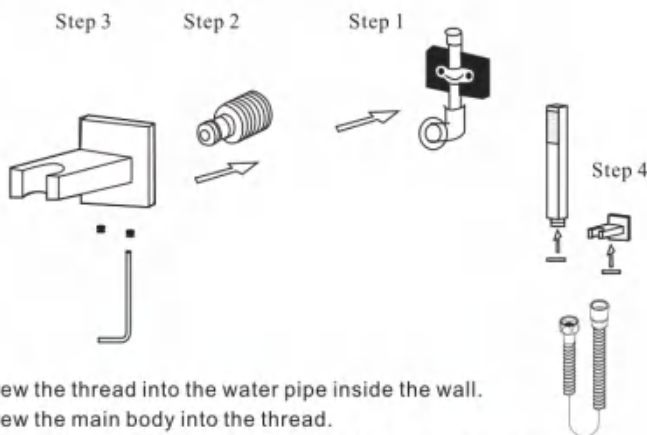

- Step 1. Screw the thread into the water pipe inside the wall.
Step 2. Screw the main body into the thread.
Step 3. Rotate and fix the body with the special-shaped wrench.
Step 4. Connect hand shower and the hose.

◆ 3 Handheld Shower Modes



Rainy water



Mixed water



Massage water

♦ CARE AND MAINTENANCE

In order to keep the mixer surface bright , please clean the mixer regularly.

Rinse faucet with clean water and wipe with soft cotton cloth.

Avoid using cleaning powder , harsh cleaning chemicals, brushes, and cloth with coarse surface to prevent scratching and corrosion.

Do not use acid cleaner to clean the faucet as it may cause surface corrosion of the faucet. If the faucet comes into contact with harmful acid substances, please rinse it with water immediately.



♦ IF A LARGE-SCALE CLEAN-UP IS NECESSARY, FOLLOW THESE PROCEDURES:

- 1: Use clean water and soft cloth to remove dirt on the surface as much as possible.
- 2: Use one of the following cleaners to remove dirt on the surface
 - Mild liquid cleaner.
 - Colorless glass cleaner, powder cleaner which does not have abrasive function and can be dissolved completely.
 - Polish liquid which does not have abrasive function.
- 3: After cleaning, remove the cleansing agent with clean water completely and wipe with soft cotton cloth.