

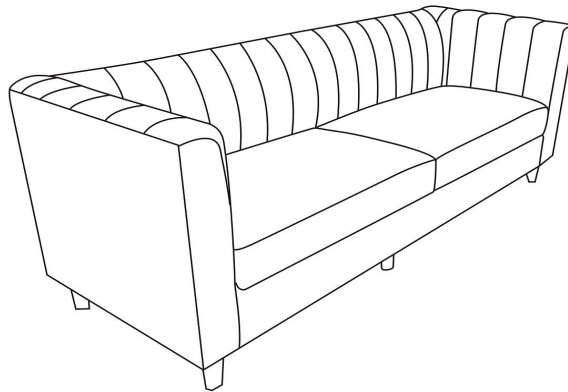

Assembly Instructions

Caution: You must read this before you proceed



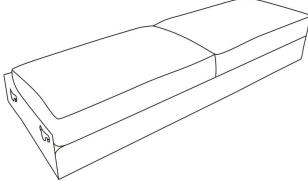
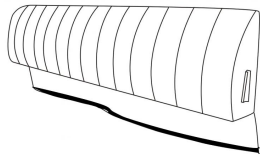
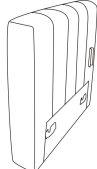

Sofa



Parts List

Label	Picture	Description	QTY(pc)
A		Sofa Base	1
B		Backrest	1
C		Left Arm	1
D		Right Arm	1
E		Leg with 1 Plastic Gasket	5

Hardware List

Label	Picture	Description	QTY
①		Plastic Gasket	7
②		Allen Wrench	1
③		Spring Ring	7
④		Flat Gasket	7
⑤		Bolt(M8*70mm)	7

Assembly Preparation

Before
Begining
Assembly:

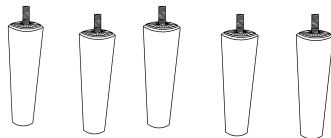
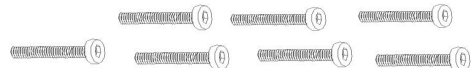
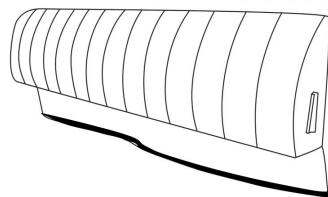
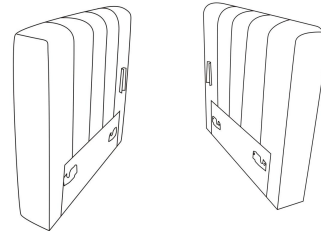
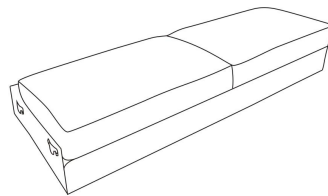

- Read instructions, cover to cover-



- Have 2 adults on hand for assembly-



- Do not assemble on flooring or carpet-



- Assemble on a clean non-marring surface (packing foam)-



- Save all packaging until finished-

Assembly Steps

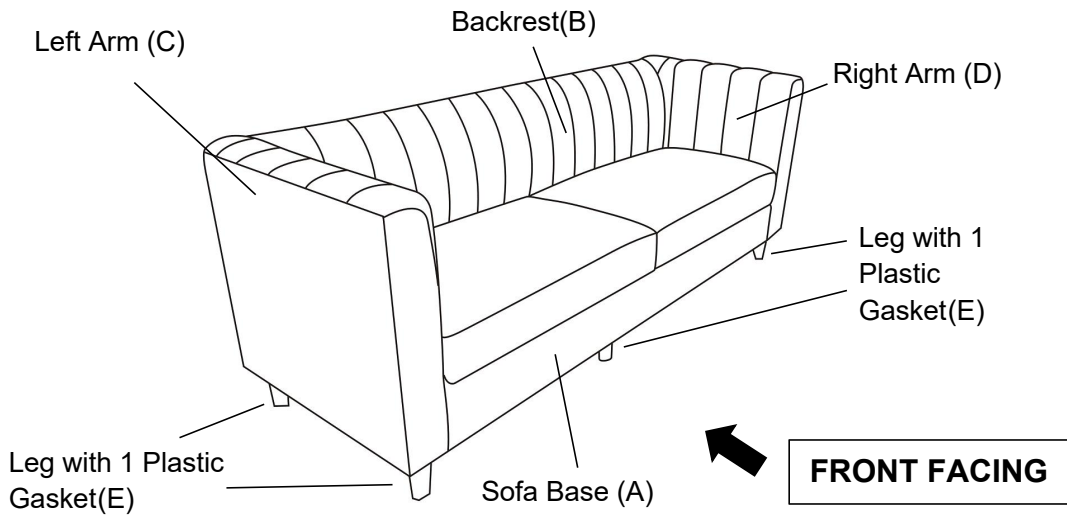

This Sofa has multiple parts and may require about 30 minutes to assemble. To give you an overview of the Sofa parts, the above picture is to help you put the various parts into perspective. Please read through the instructions below to familiarise yourself with the parts and steps before assembly.

Step 1

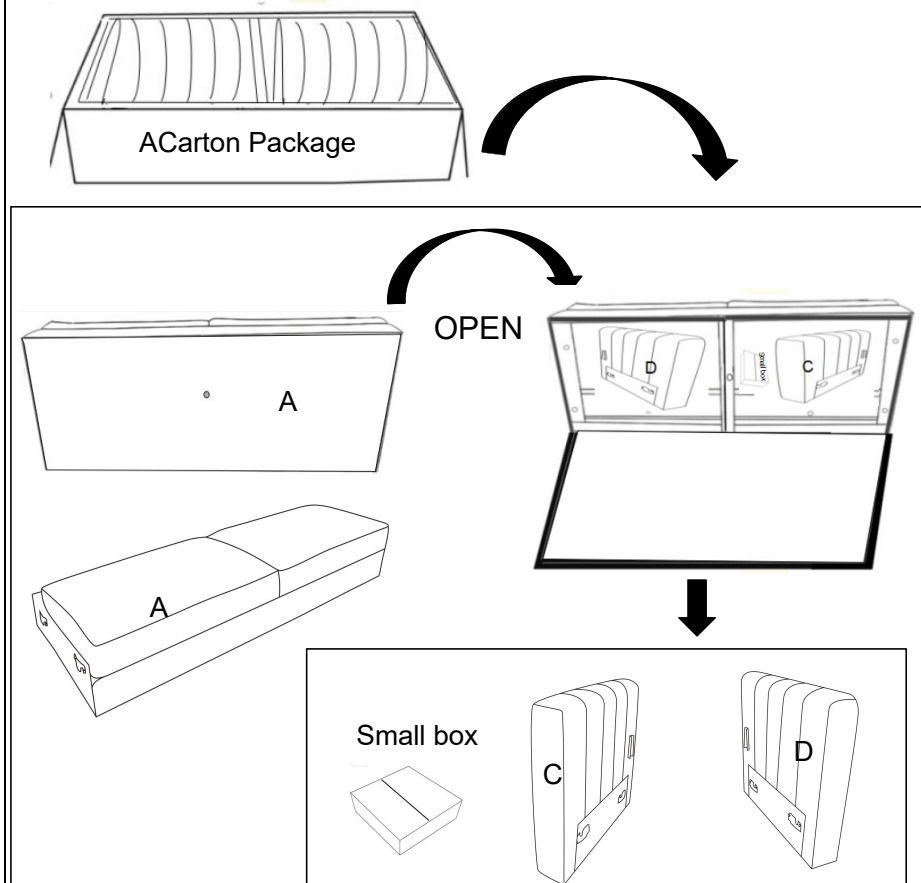

Take the Sofa Base(A), Left Arm (C), Right Arm(D) and small box out from the carton "A" and place them on a clean, non-marring surface.

Step 2

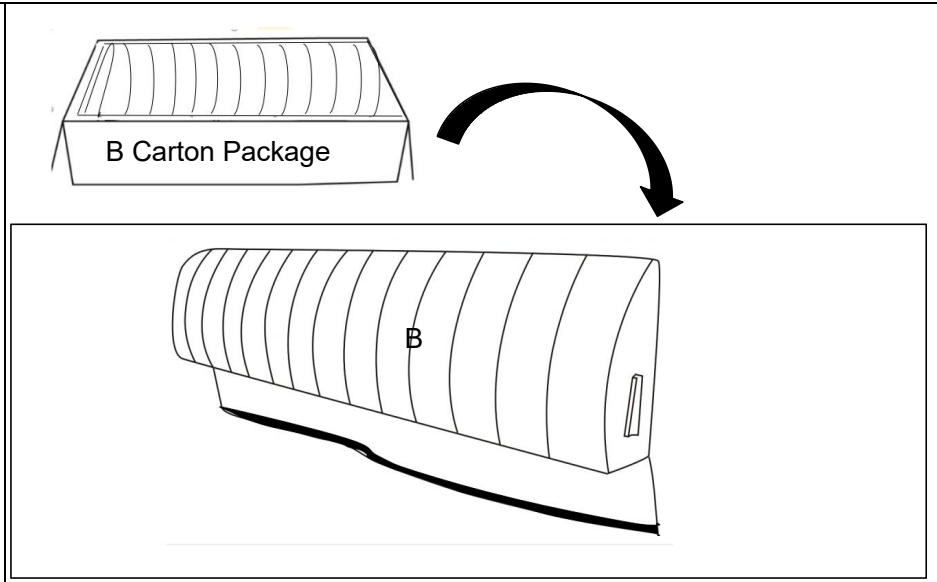

Take out the Backrest(B) from the Carton "B", place them on a clean, non-marring surface.

Step 3

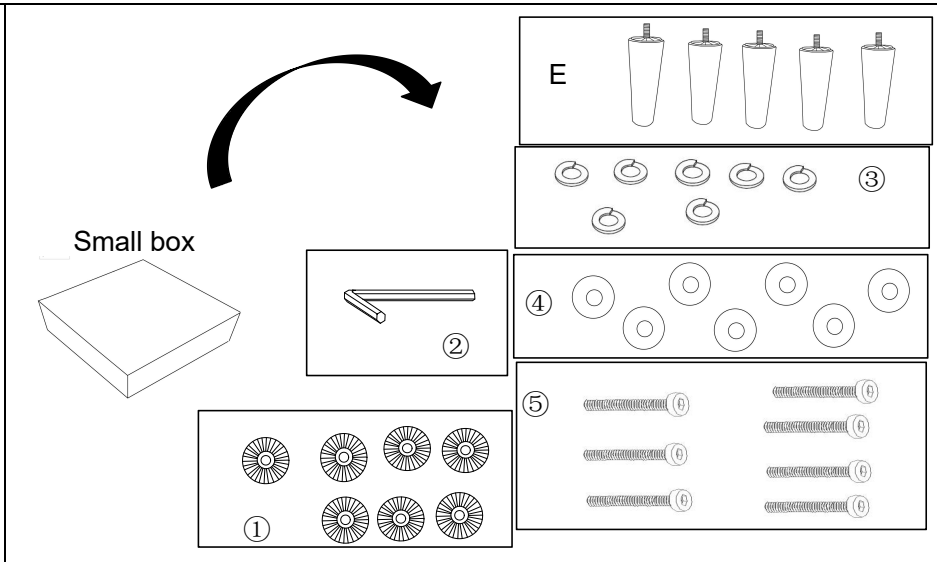

Open the Small Box to take out the Wooden Legs(E) and Hardwares.

Step 4

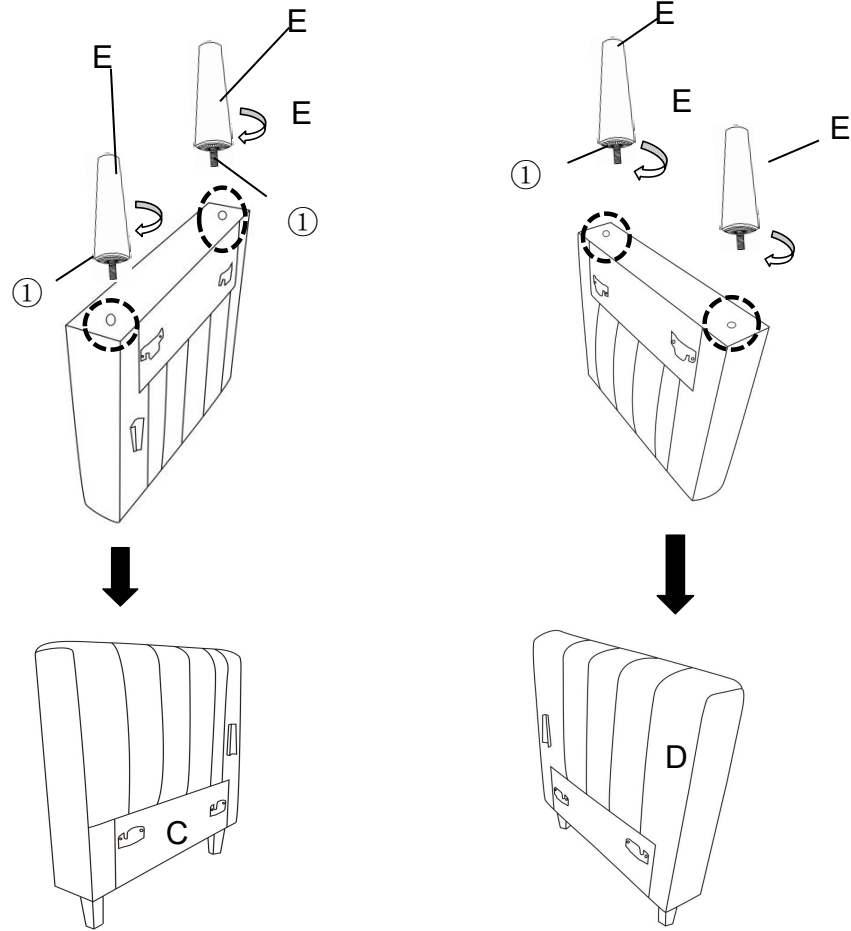

Carefully install the Wooden Legs(E) at the bottom of Left Arm(C) and Right Arm(D). Insert threaded stem into the mounting position at the corner of Left Arm(C) and Right Arm(D). Tighten by turning the Legs clockwise.

Take care of the shape of the Legs and ensure they in the correct positions.

Note:The use of Gasket(1) are **OPTIONAL** and are especially useful to help alleviate slight wobbleness. Some Legs may need more than one gasket (1) while some legs may not need any.

Step 5

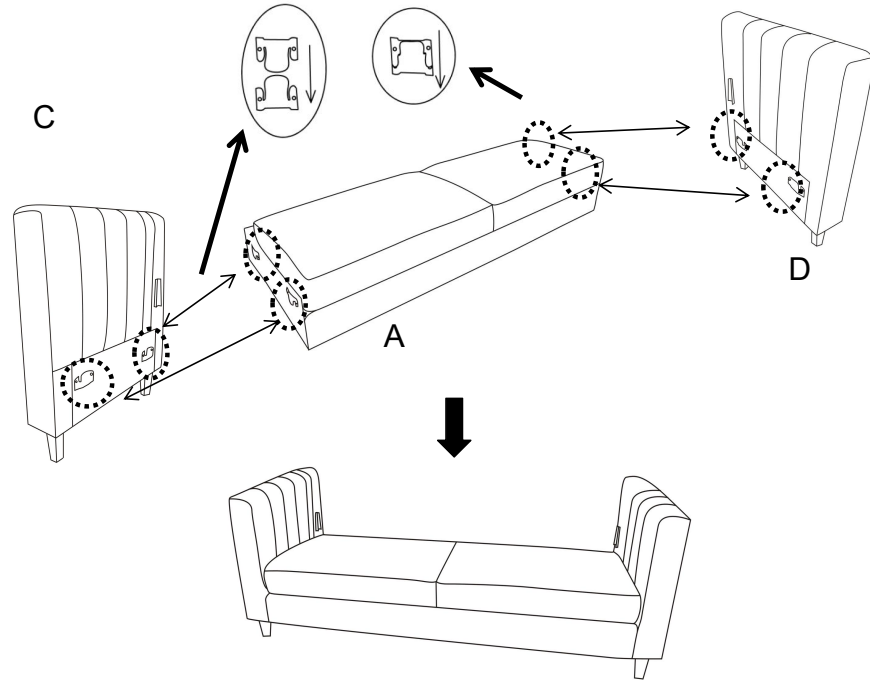

With assistance from your adult partner, align the mounting brackets on the Sofa Base(A) with those on the Left Arm(C) and Right Arm(D). Then slide Sofa Base(A) downward to make sure it locks into place as pictured.

Step 6

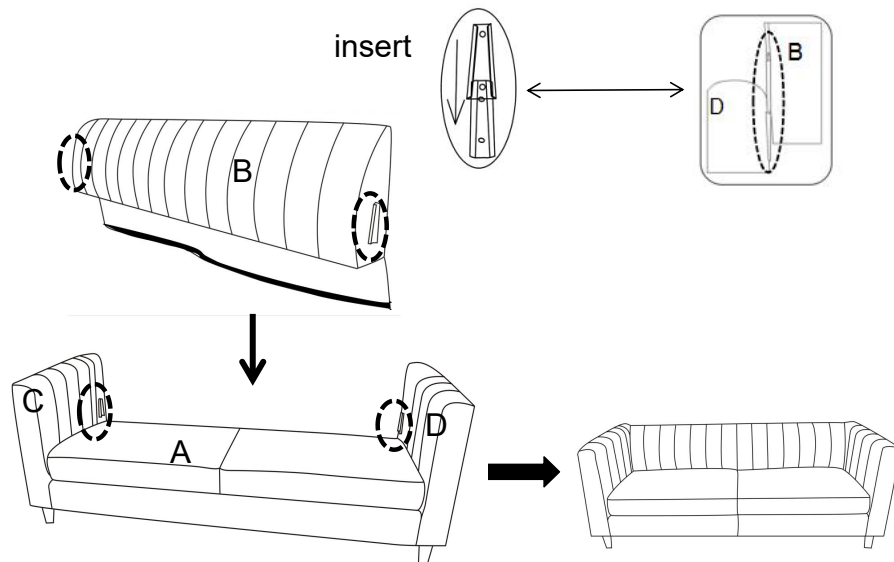

With assistance from your adult partner, align the mounting brackets on the Backrest(B) with those on the Left Arm(C) and Right Arm(D). Then slide Backrest(B) downward to make sure it locks into place as pictured. Please squeeze the armrests properly against the backrest to ensure that the inserts can be assembled smoothly.

Step 7

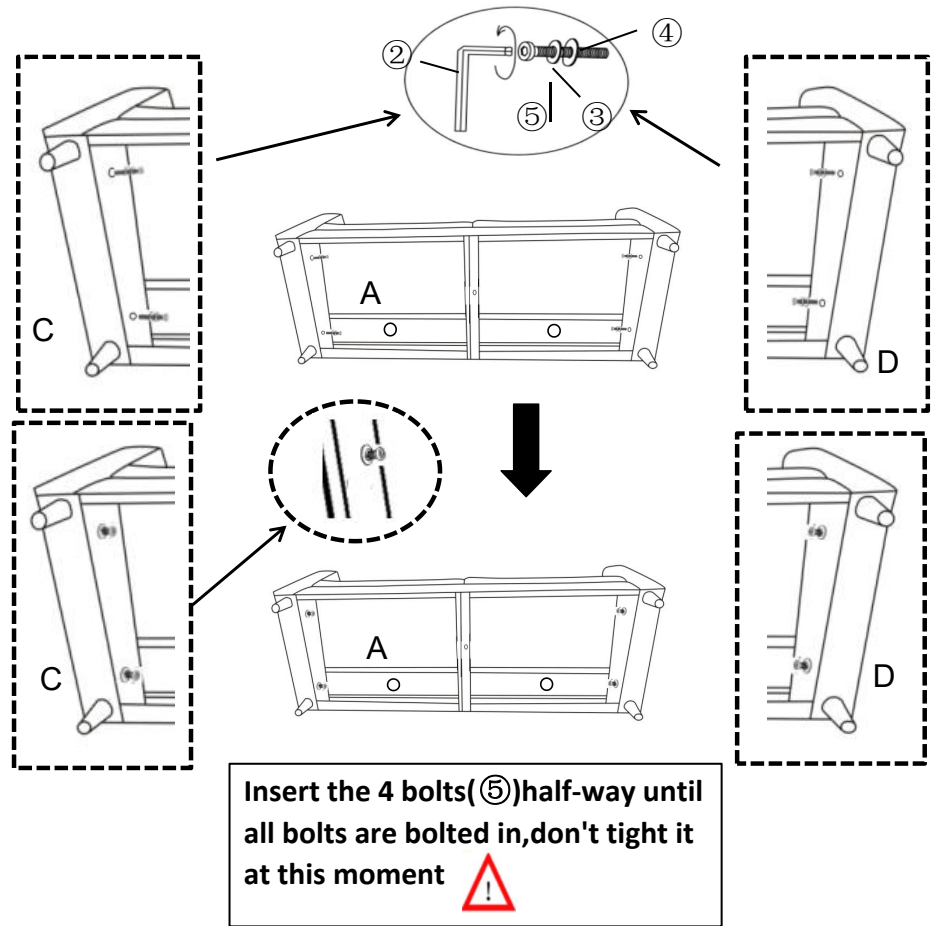

Using the Allen Wrench(2) secure Left Arm(C) and Right Arm(D) to the both sides of Sofa Base(A) with Bolts(5), Spring Washers(3)and Flat Gaskets(4).
Insert all the Bolts(5) half-way starting one by one as pictured.
Don't tighten it at this moment.

Step 8

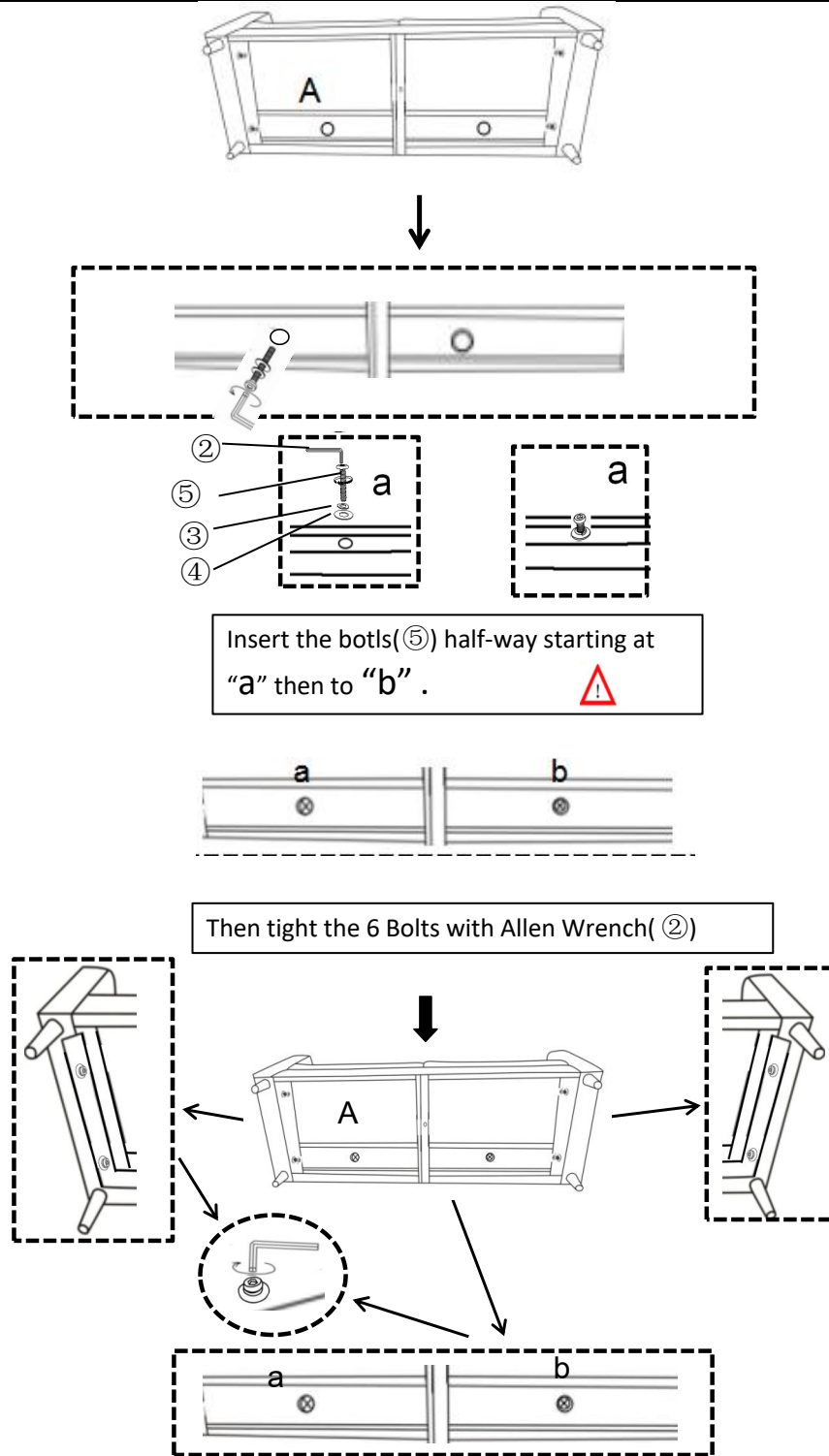

Secure Backrest(B) to the bottom of Seat Base(A) using Bolts(⑤), Spring Ring(③) and Flat Gasket(④) with Allen Wrench(②).
Insert Bolts(⑤) half-way starting at "a" then to "b", until all bolts(⑤) are bolted in.
Then tight the 6 Bolts with Allen Wrench(②)

Step 9

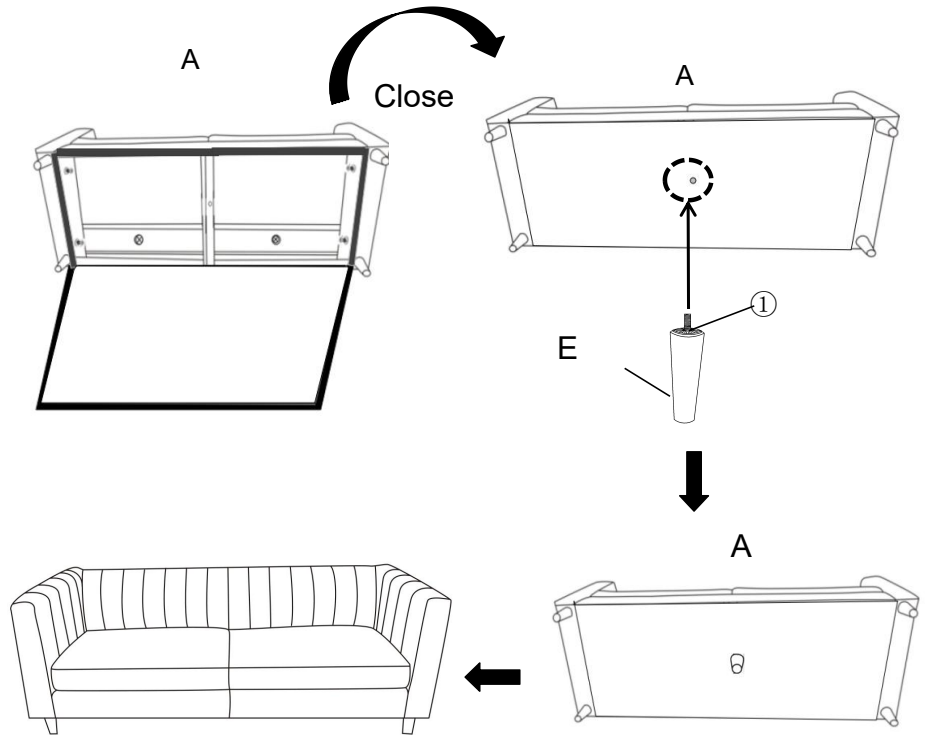

Carefully install the middle Wooden Leg(E) at the bottom of Sofa Base(A). Glue the bottom cloth with Burrs, then install the legs in the middle.

Step 10

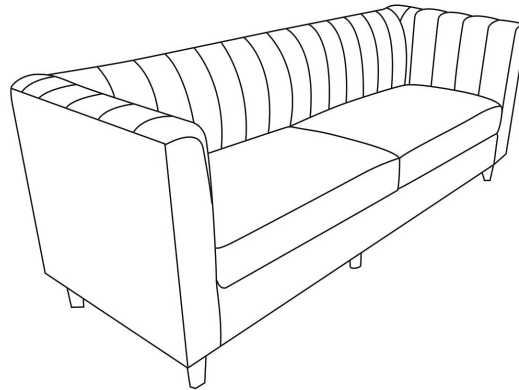

Your Sofa is ready for use.
This Sofa can only be used on a flat, level surface.