

INSTALLATION INSTRUCTIONS FOR OUTDOOR WALL LIGHT



INSTRUCTIONS PERTAINING TO RISK OF FIRE OR INJURY TO PERSONS
READ ALL INSTRUCTIONS

IMPORTANT SAFETY
INSTRUCTIONS

SAVE THESE INSTRUCTIONS

Before starting the installation, disconnect the Power by Turning Off the Circuit Breaker. Turning the Power Off using the LightSwitch is not sufficient to prevent electrical shock. All electrical connections and installation must be following local codes, ordinances, and/or National Electric Code and Must Be Done by an Electrician Only.

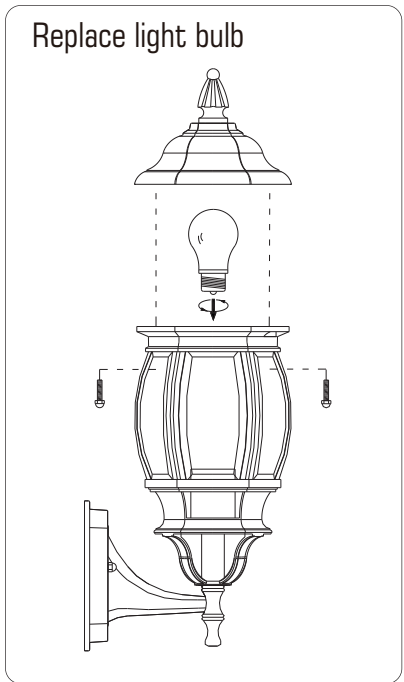
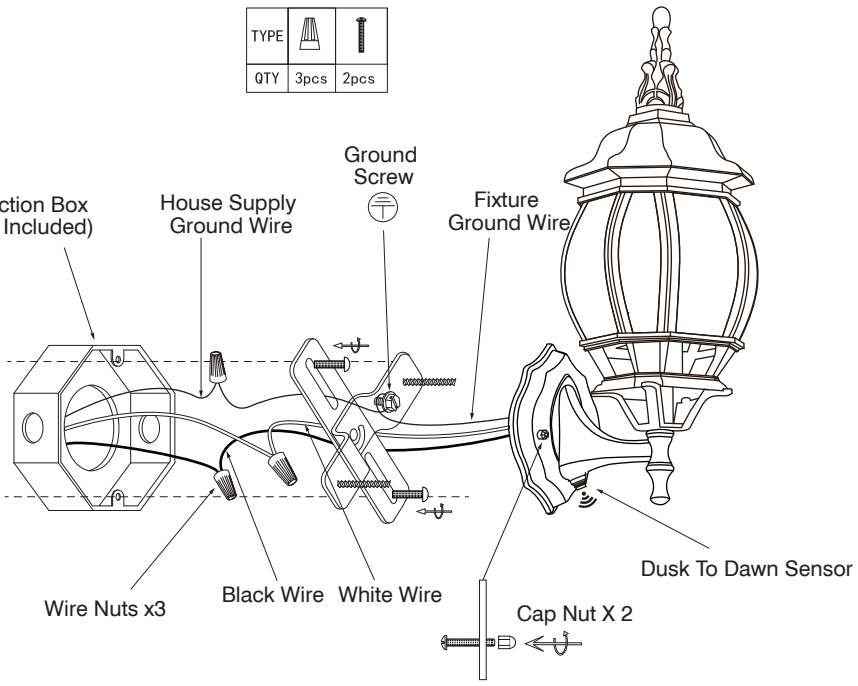

PRODUCT DETAILS

Dusk To Dawn Sensor

The sensor can turn on and off the lamp according to the ambient light. When the light is dark, such as at night (5-60Lux Outdoor natural light), the lamp will automatically turn on, and when the surrounding environment is bright, such as after dawn, the lamp will automatically turn off.

So you don't have to manually turn on or off the lights, you can keep the switch always on, and automatically turn on and off every day, saving your electricity bills. If you want to disable this feature, cover the sensor with dark tape.

- Power Source:** Corded Electric
- Voltage:** 120V AC
- Bulb Support:**
- All E26 base bulbs
- Max: 100W
- (Bulb not included)

1 YEAR LIMITED WARRANTY*

This Light Fixture is warranted against defects in material and quality for 1 year from the purchase date. This warranty does not cover acts of nature such as lighting damage or corrosion and discoloration of components. Nor does it cover damages caused through abuse, improper installation, surges in electric current, or acts of third parties. This warranty does not cover the costs of removing and resealing the lighting fixture. If this product falls for any reason covered by this warranty, feel free to contact us.

ASSEMBLY INSTRUCTIONS

TOOLS AND MATERIALS REQUIRED:



SAFETY PRECAUTIONS:

1. Turn off electrical power before starting the installation of the light fixture.
 2. This product must be installed in accordance with the applicable installation code by a person familiar with the construction and operation of the product and the hazards involved.
 3. Firmly attach the fixture ground wire (bare copper) to the mounting bracket with the ground screw (by wrapping around the ground screw) and then connect it to the house supply ground wire with a wire nut.
 4. To clean the fixture, turn off the power, wait for it to cool, and wipe the fixture with a clean, soft cloth.
- Note: the product may not look exactly as shown in the figures.

INSTALLATION:

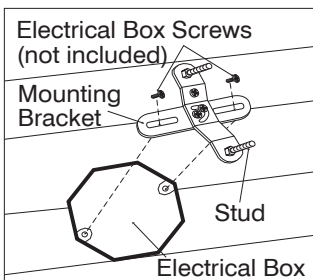

1. Mount the mounting bracket to the electrical box using electrical box screws (not included). Make sure the studs on the mounting bracket are facing out from the electrical box.

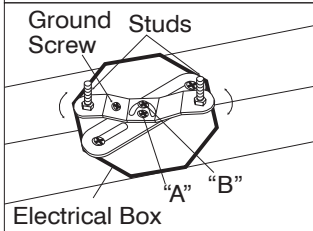

2. Position the mounting bracket so that the fixture will sit level once it is mounted to the wall. Tighten screws "A" and "B" to hold in place.

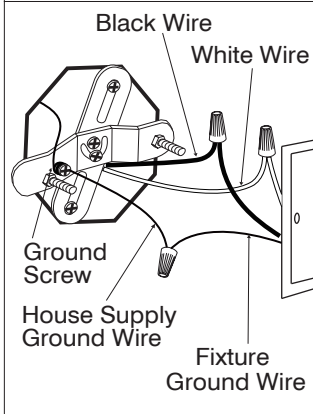

3. Firmly attach the fixture ground wire (bare copper) to the mounting bracket with the ground screw (by wrapping around the ground screw) and then connect it to the house supply ground wire with a wire nut. Connect black wire from fixture to black wire in the electrical box and connect the white wire from fixture to white wire in the electrical box.

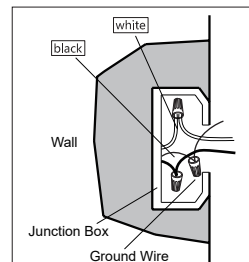

4. Once connections of wires are completed, carefully tuck wires and wire nuts into the electrical box making sure no bare wire (on the black and white) is visible at the wire nuts. Position fixture over studs on mounting bracket assembly. A secure fixture in place cap nut(s).

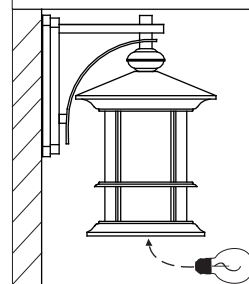

5. Install the proper bulb type and wattage (not included). Note: Please use dimmable led bulbs or incandescent bulbs to be compatible with wall lights and avoid flicker problems. Very few models of dimming bulbs may have compatibility issues. If flickering occurs, please consider replacing dimming bulbs of other brands.

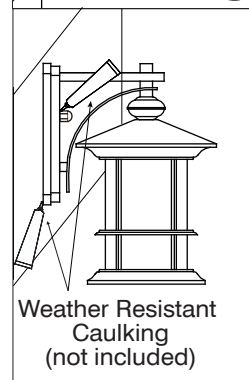

6. After Installation, seal around the top and side perimeter between the fixture and the wall surface with weather-resistant caulking. The bottom should be left un-caulked to prevent moisture build-up. Apply a small amount of weather-resistant caulking around the side perimeter between the cap nut and mounting plate.