

C END TABLE

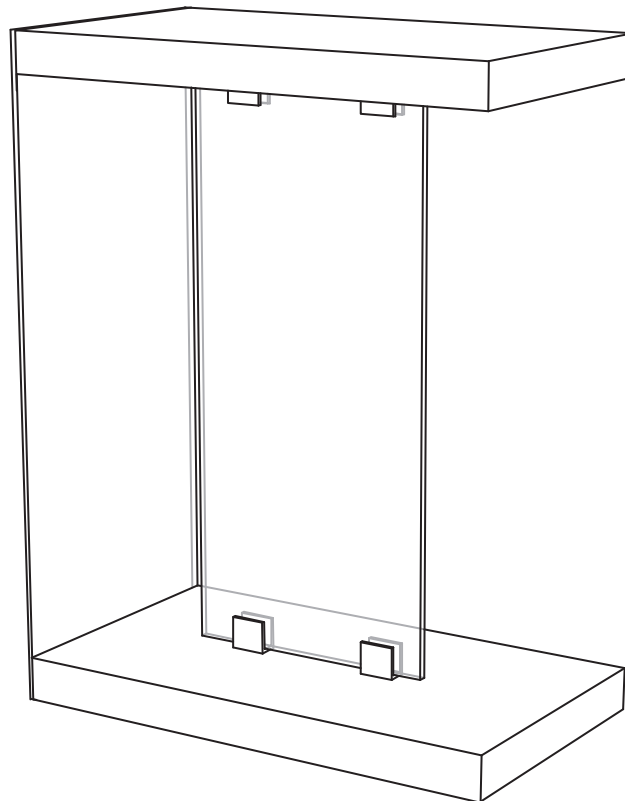





THANK YOU FOR YOUR ORDER!
ENCLOSED PLEASE FIND A POLISHING CLOTH FOR YOUR USE TO CLEAN THE GLASS
OF THIS PRODUCT.
PLEASE ALSO CALL US IF YOU HAVE ANY QUESTIONS.



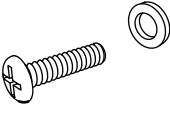

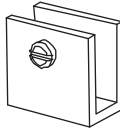
ASSEMBLY INSTRUCTIONS

We have designed our furniture with you , the customer in mind . Our clear , easy to follow , step by step instructions will guide you through the project from start to finish . Feel confident that this will be a fun and rewarding project . The final product will be a quality piece of furniture that will go together smoothly and give years of enjoyment .

Hardware List

A  Screw and washer (4pcs)	B  Locking nut (4pcs)	C  Bracket (4pcs)	D  Small Screw (4pcs)	E  Polishing cloth (1pc)
---	--	--	--	---

Panel List

①  Top panel (1pc)	②  Side panel (1pc)	③  Bottom panel (1pc)	④  Glass panel (1pc)
---	--	---	---

Step 1

1. Connect brackets (C) to top panel ① as show using small screws (D) .
2. Connect brackets (C) to bottom panel ③ as show using small screws (D) .

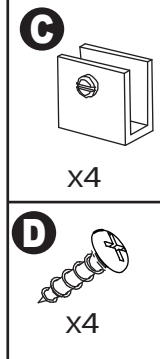
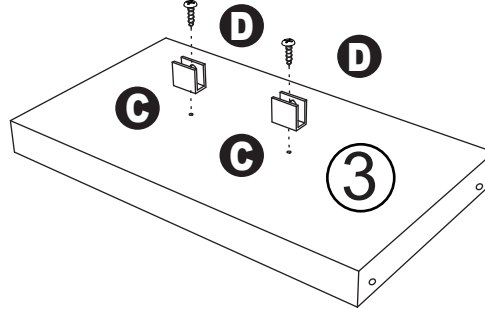
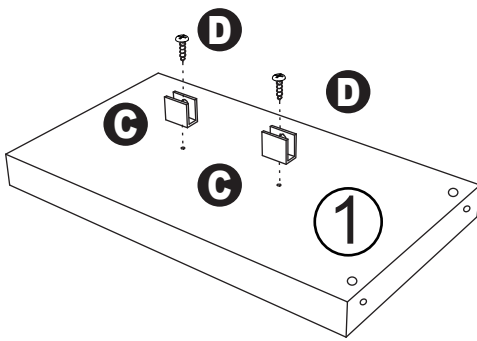

Step 2

Place face down on carpet or soft surface.

1. Insert locking nuts (B) into top panel ① and bottom panel ③.
2. Connect the side panel ② to top panel ① and bottom panel ③ using screws and washers (A).

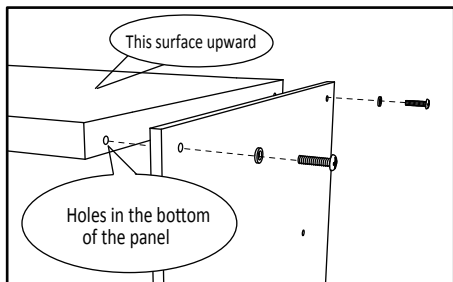
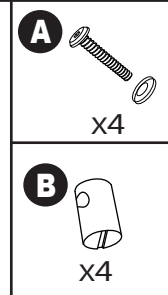
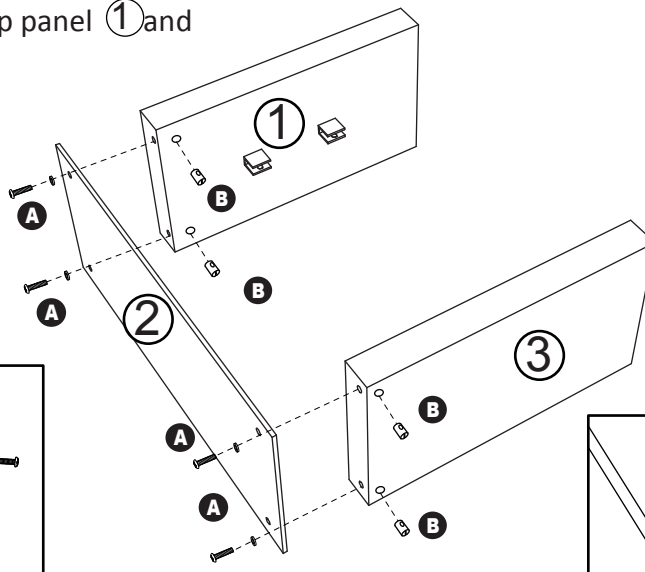

*Note.
Make sure threads of lock nuts face bolt holes.

Step 3

1. Place the unit upright.
2. Using a slight angle, carefully insert glass panels ④ into unit.

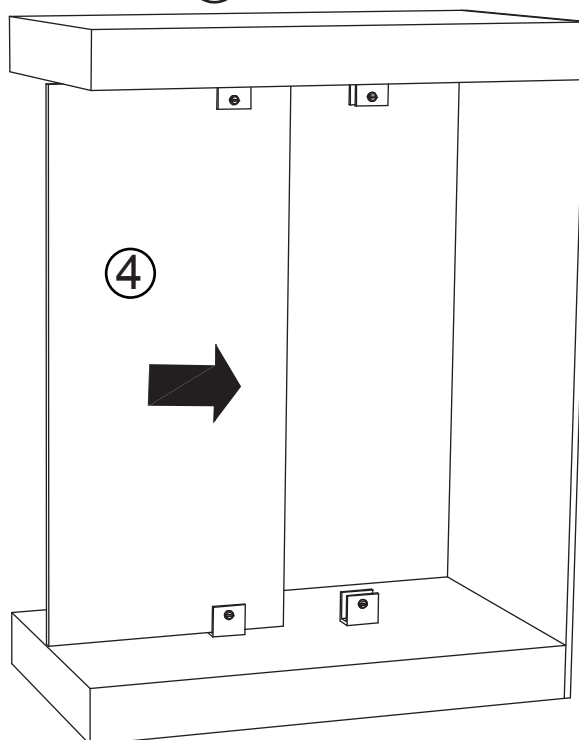

Step 4

1. Carefully lock the bracket screws.
2. Enjoy!

