

INSTALLATION

TV TABLE

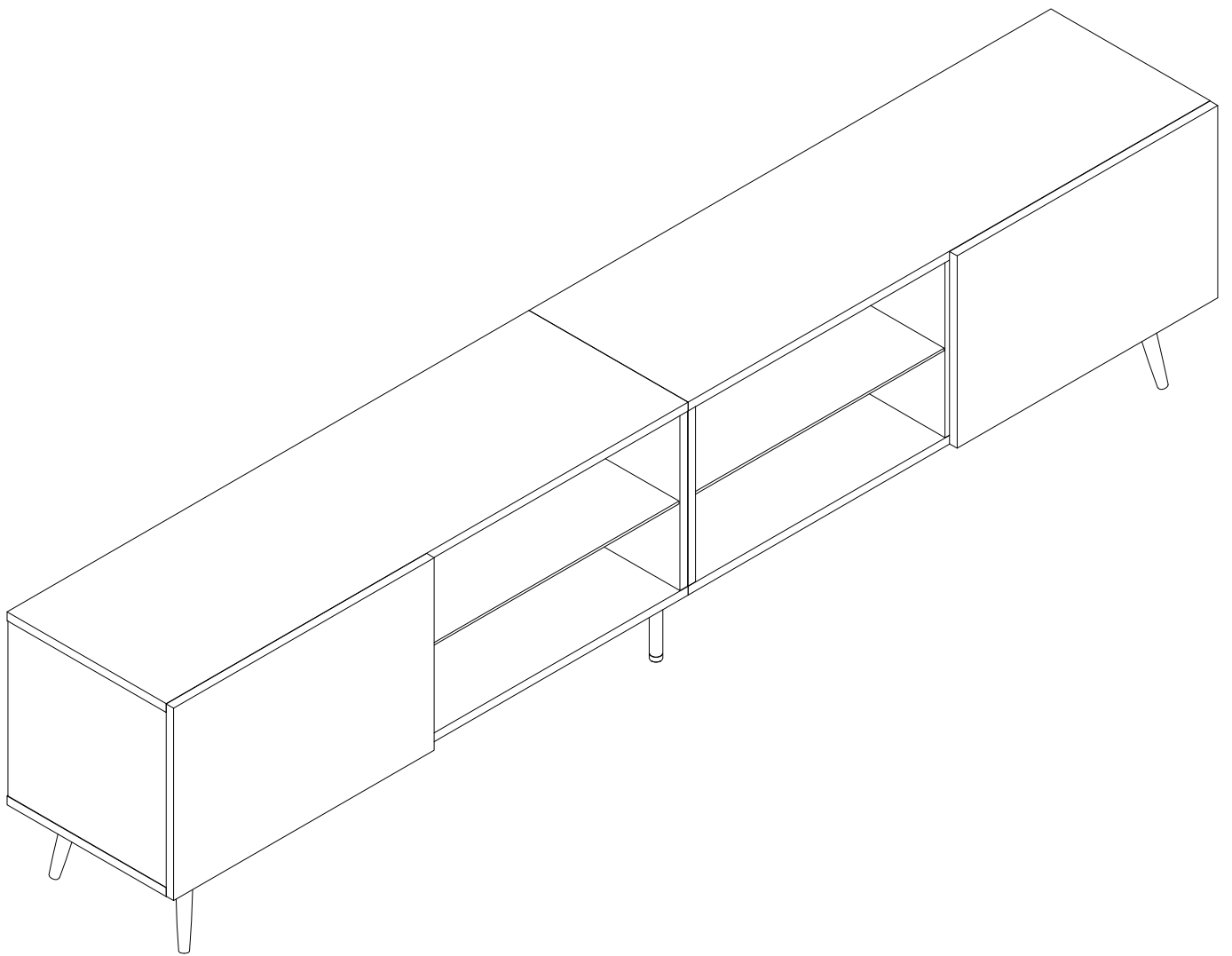

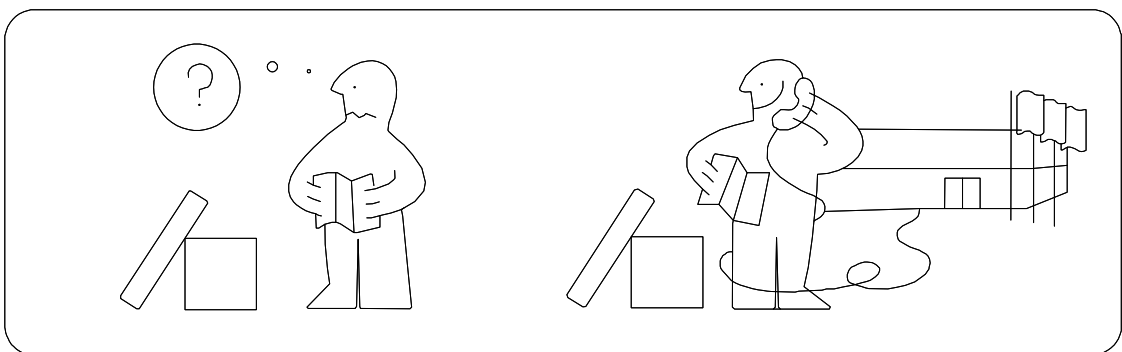

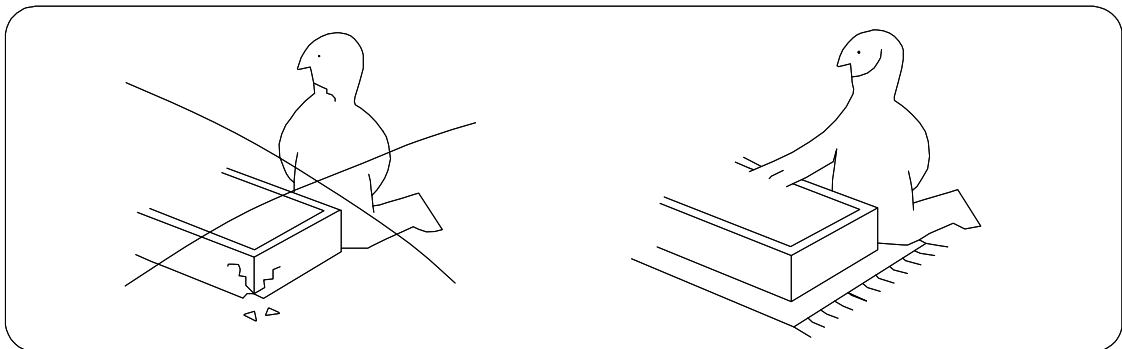
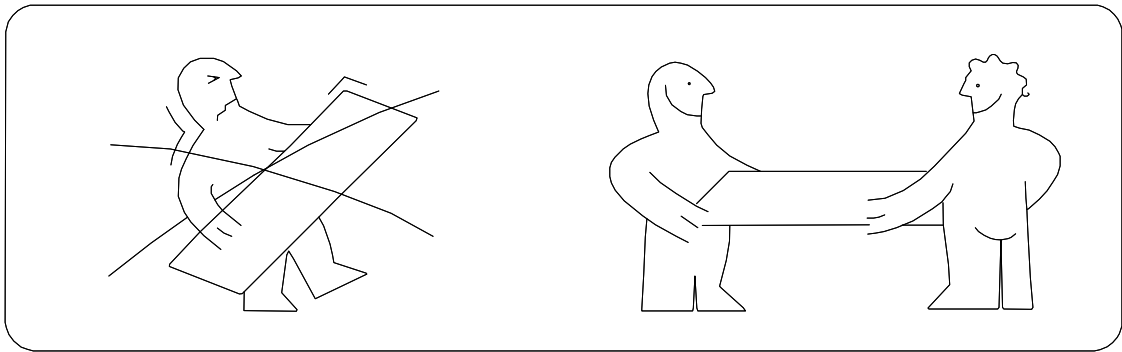
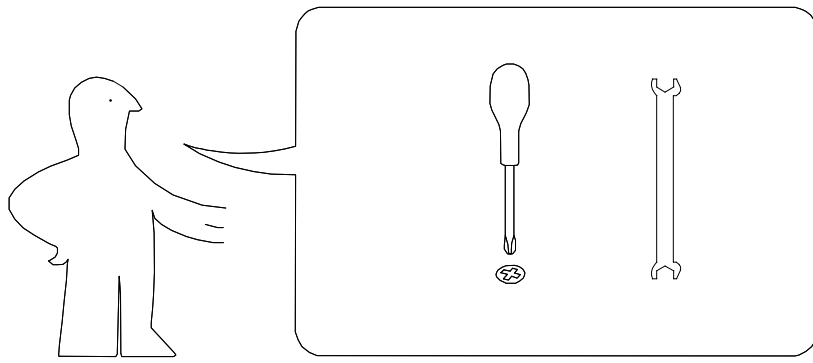
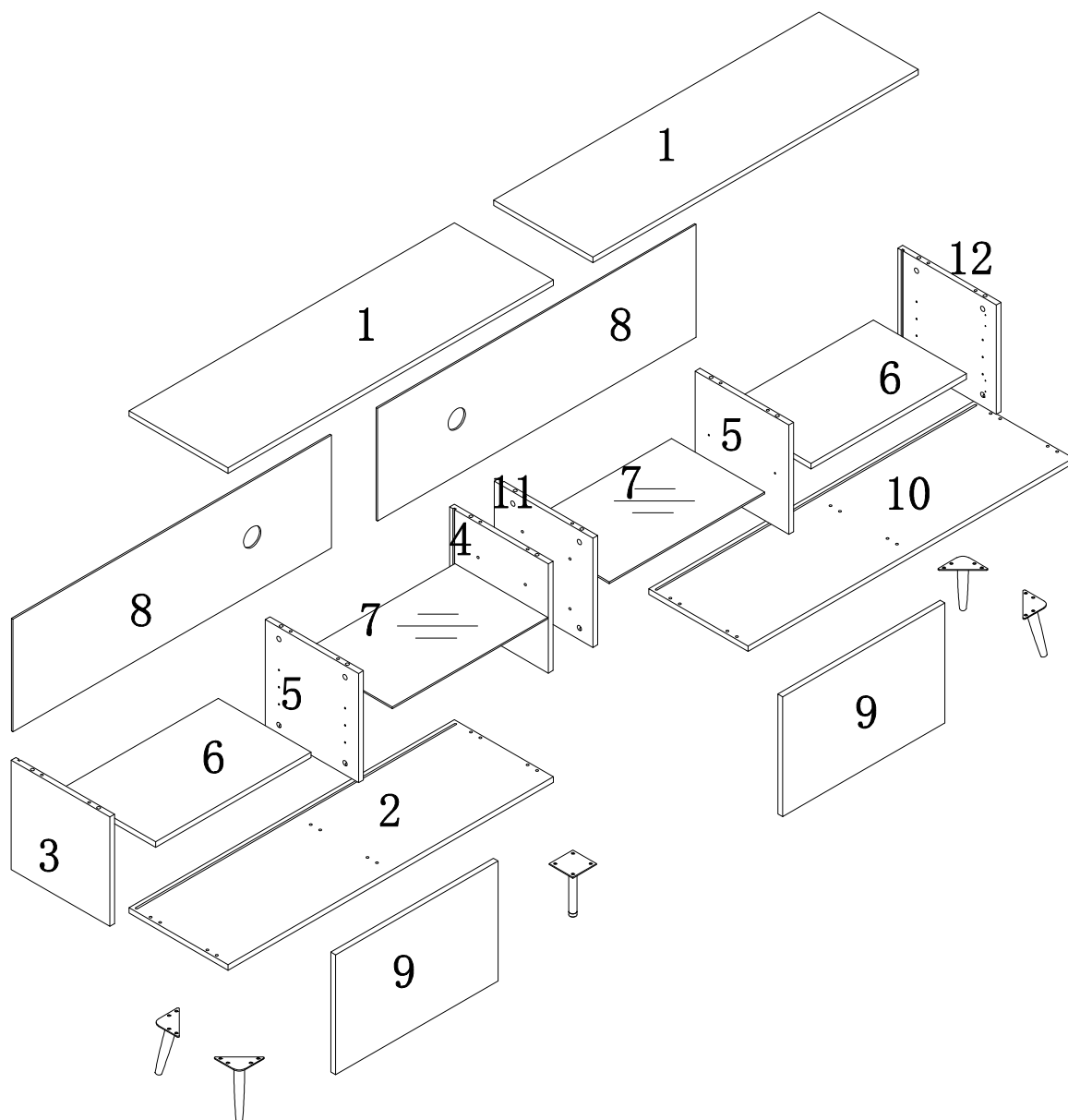







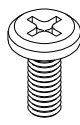



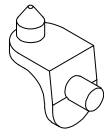
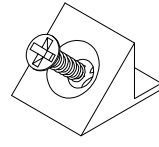
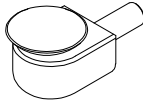

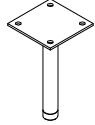
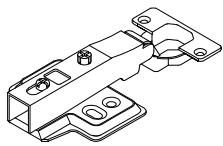
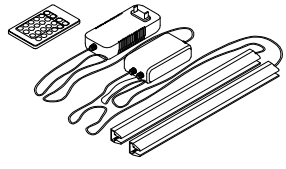
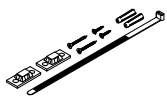
NO.	SIZE	QTY
1	1100*335*16	2
2	1100*335*16	1
3	333.5*320*16	1
4	333.5*320*16	1
5	316*320*16	2
6	525*314*16	2

NO.	SIZE	QTY
7	GLASS	2
8	1077*330*5	2
9	549*351*16	2
10	1100*335*16	1
11	333.5*320*16	1
12	333.5*320*16	1

								
A	L=42mm	25pcs (1pc spare)	B	∅15*13.5	25pcs (1pc spare)	C	∅8*30	25pcs (1pc spare)
								
D	M6*15	21pcs (1pc spare)	E	M6*25	4pcs	F	/	4pcs
								
G	L4	2pcs	H	/	8pcs	I	/	9pcs (1pc spare)
								
J	/	8pcs	K	/	4pcs	M	/	1pcs
								
N	/	4set	O	/	1set	P	/	1set

STEP 1

								
A	L=42mm	12pcs	B	$\phi 15 \times 13.5$	6pcs	C	$\phi 8 \times 30$	12pcs

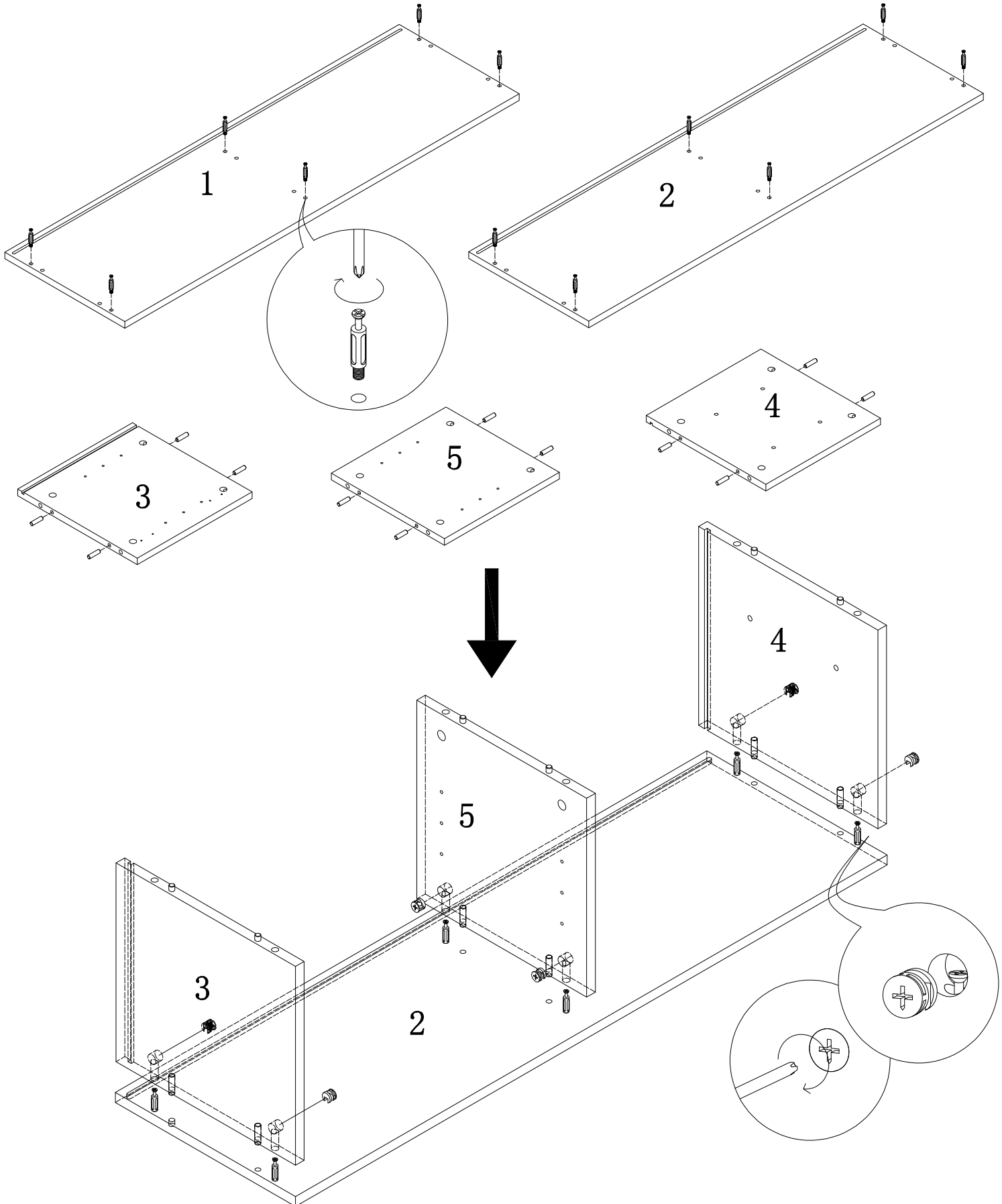

STEP 2

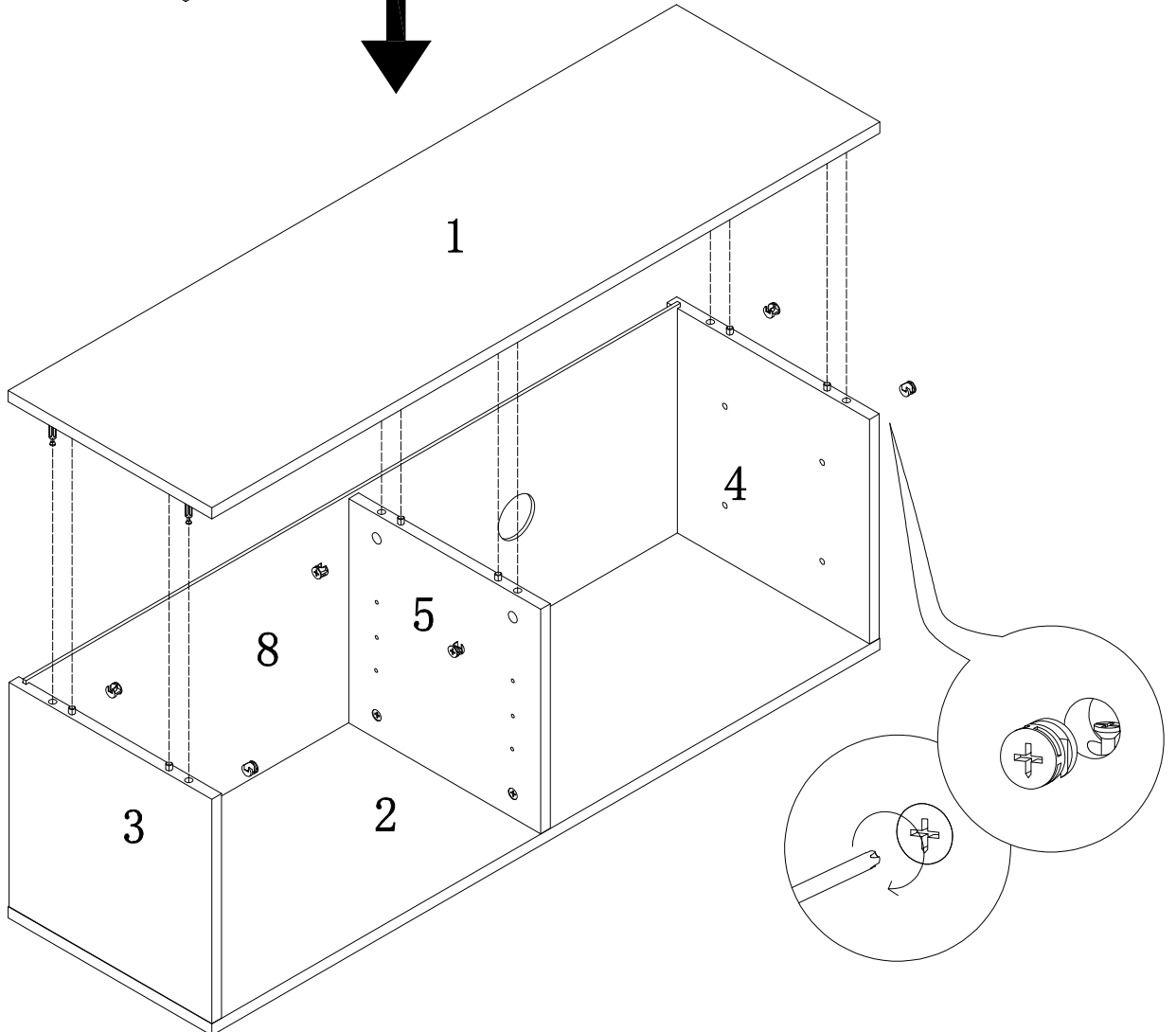
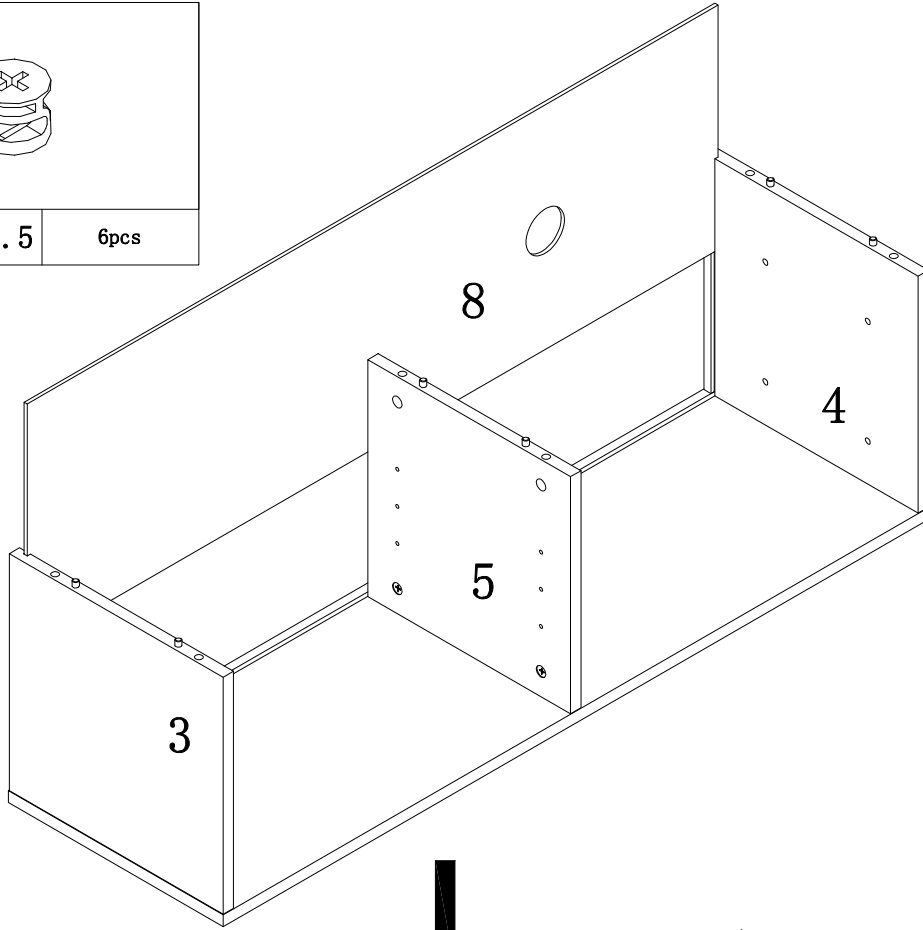
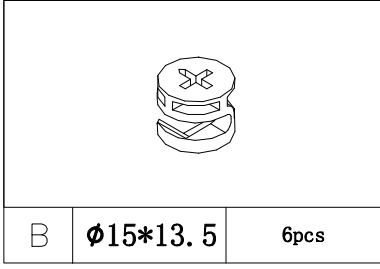

STEP 3

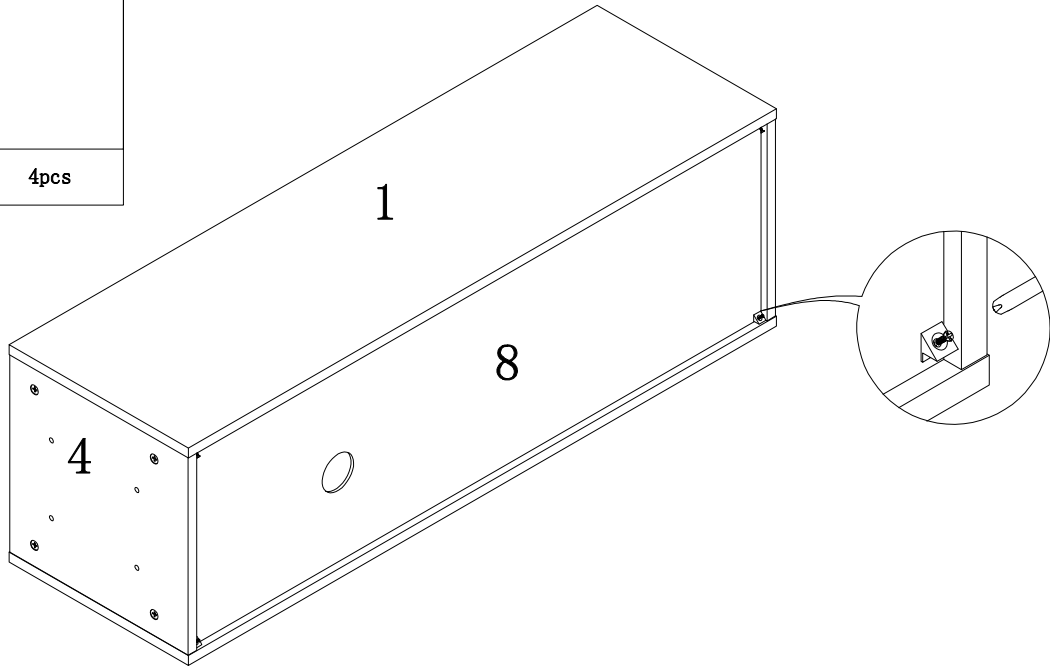
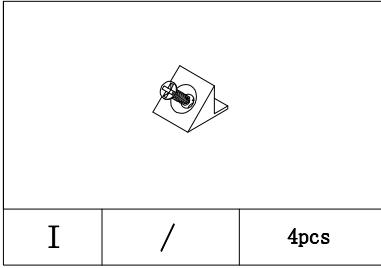

STEP 4

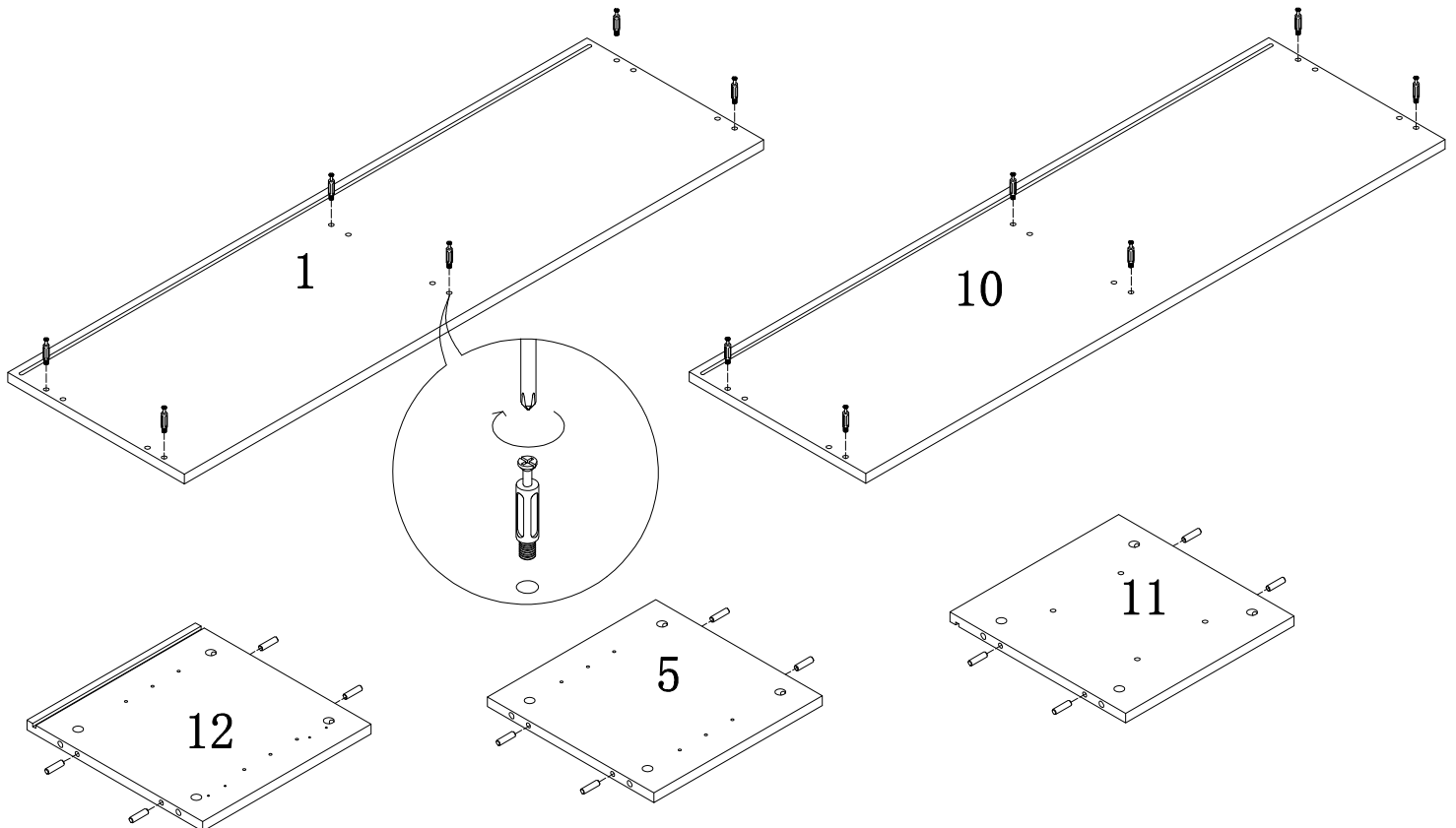
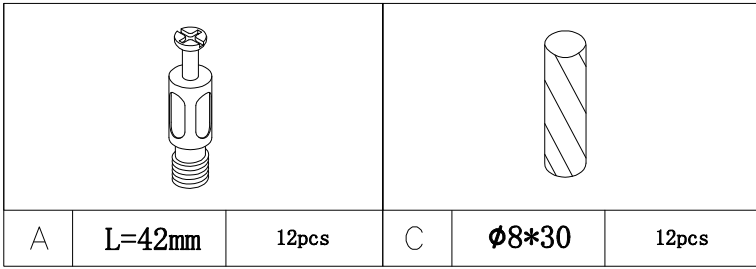

STEP 5

		
B	$\phi 15 * 13.5$	12pcs

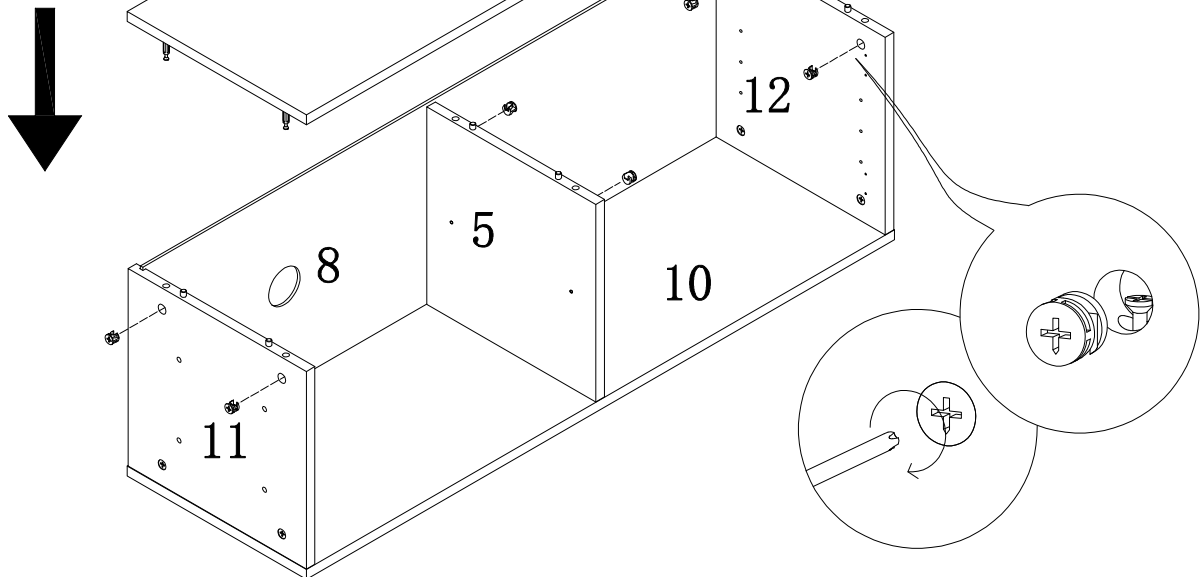
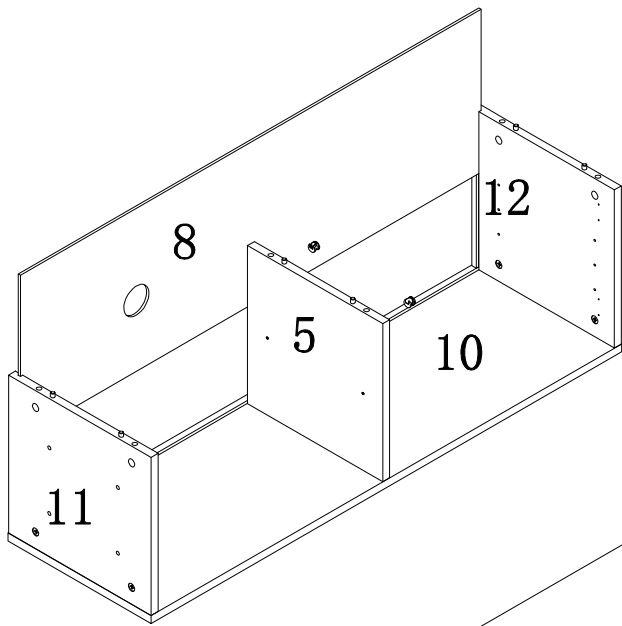
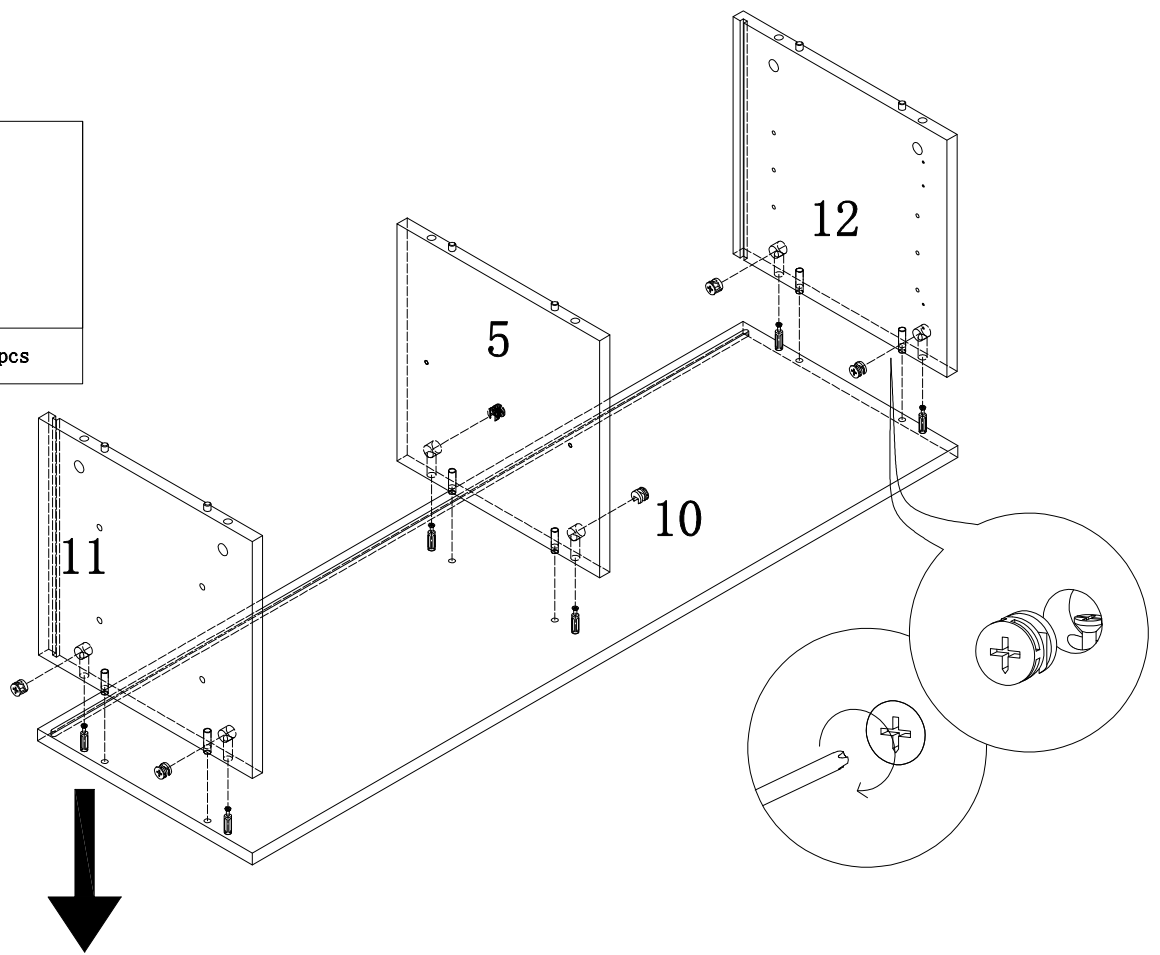

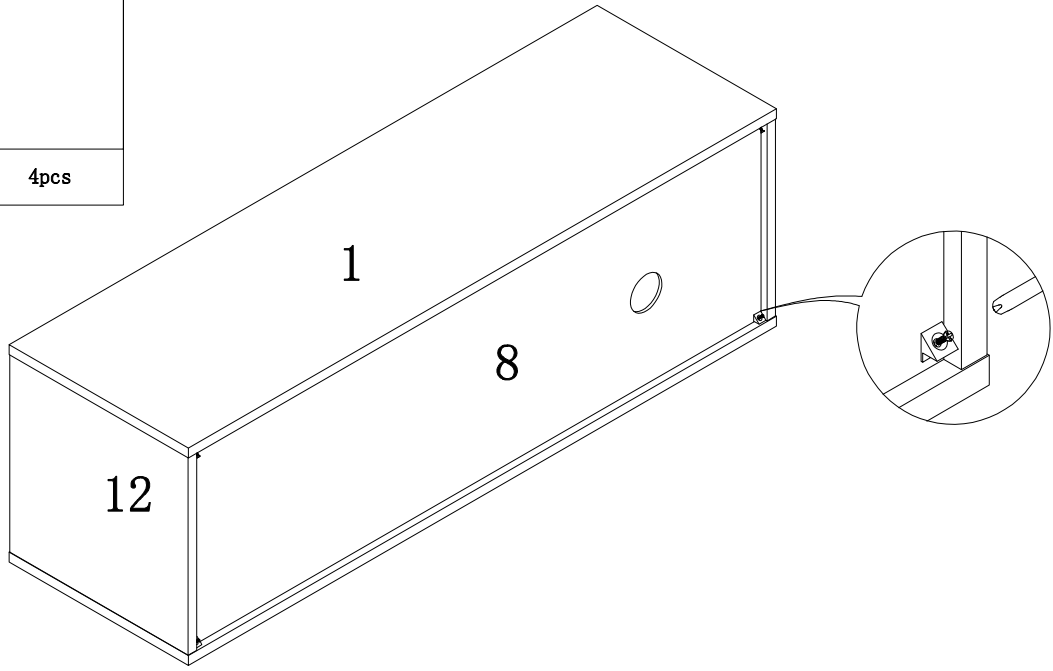
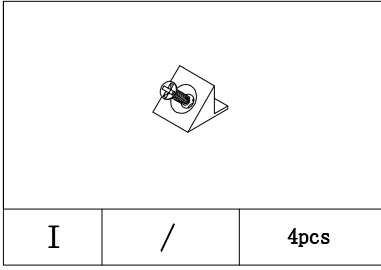

STEP 6

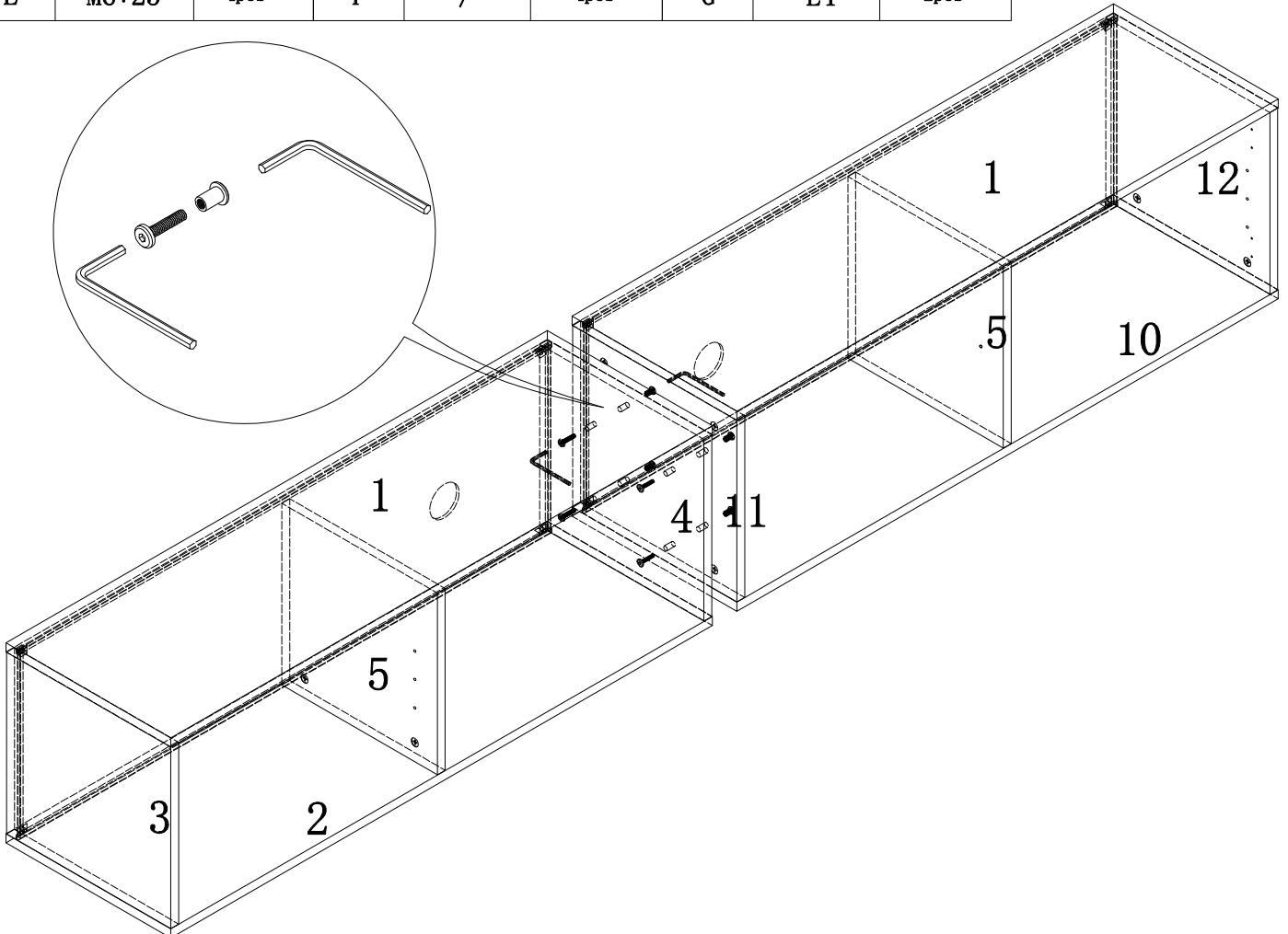
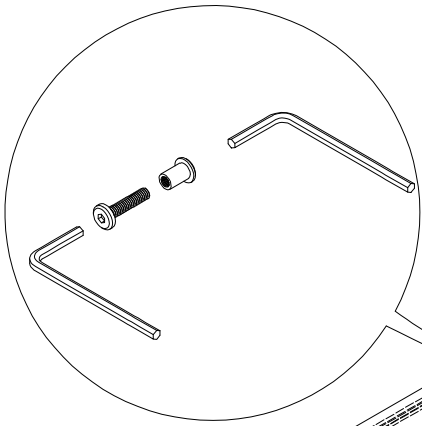
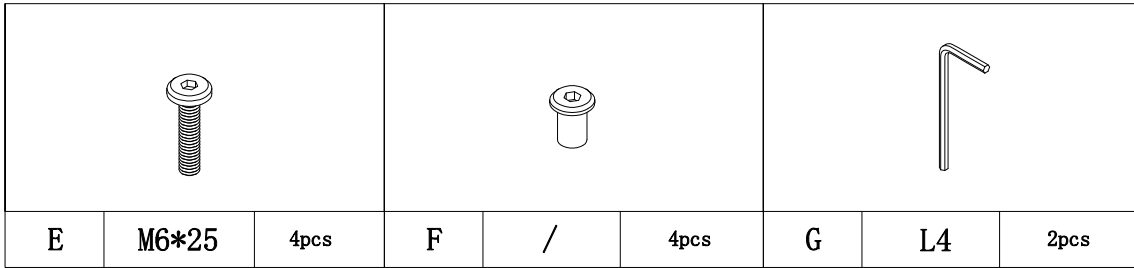

STEP 7

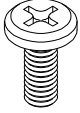

STEP 8

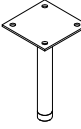
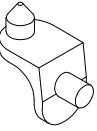
											
D	M6*15	20pcs	K	/	4pcs	M	/	1pcs	H	/	8pcs

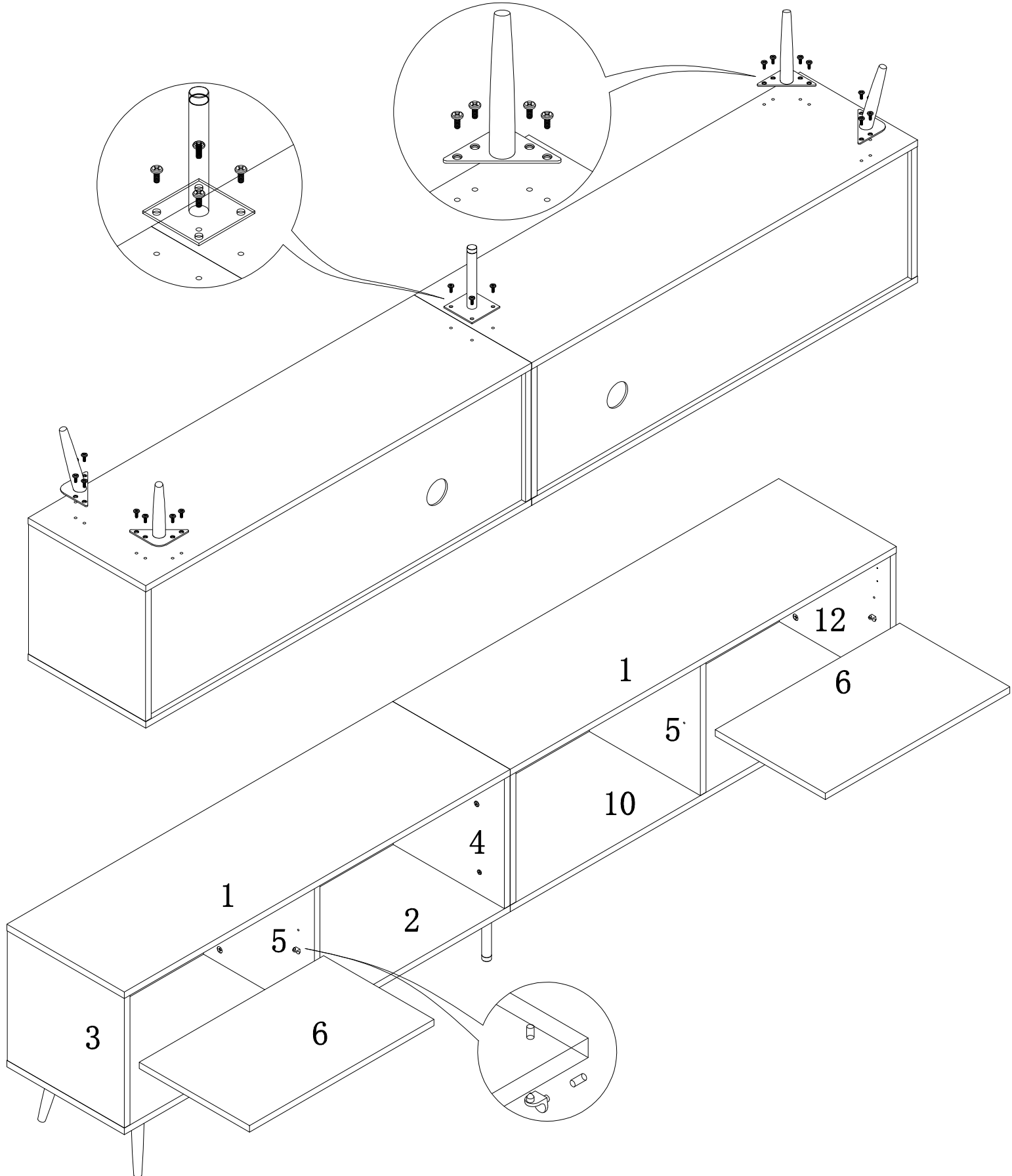

STEP 9

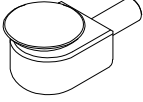
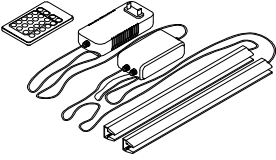

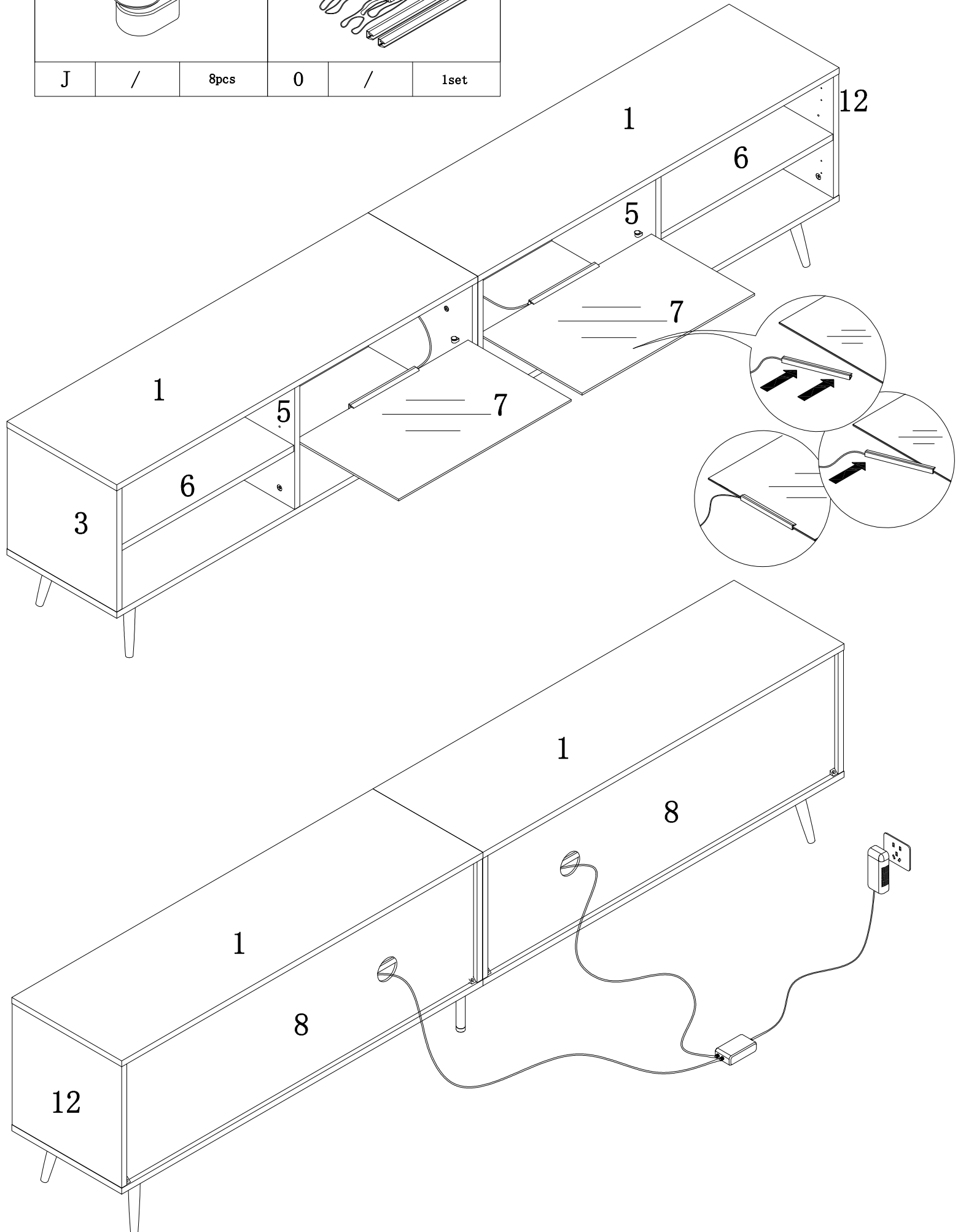

					
J	/	8pcs	0	/	1set

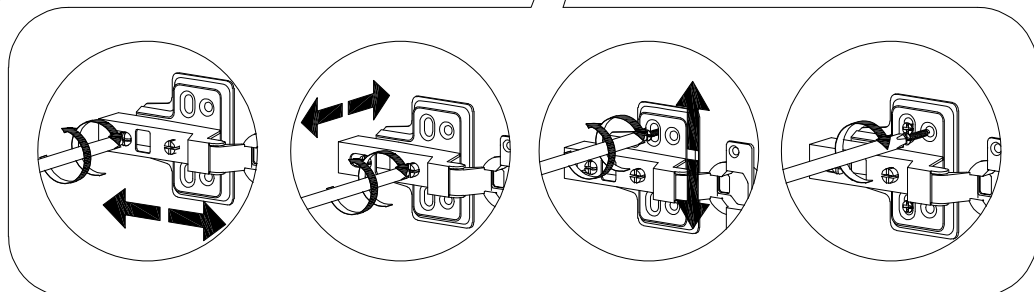
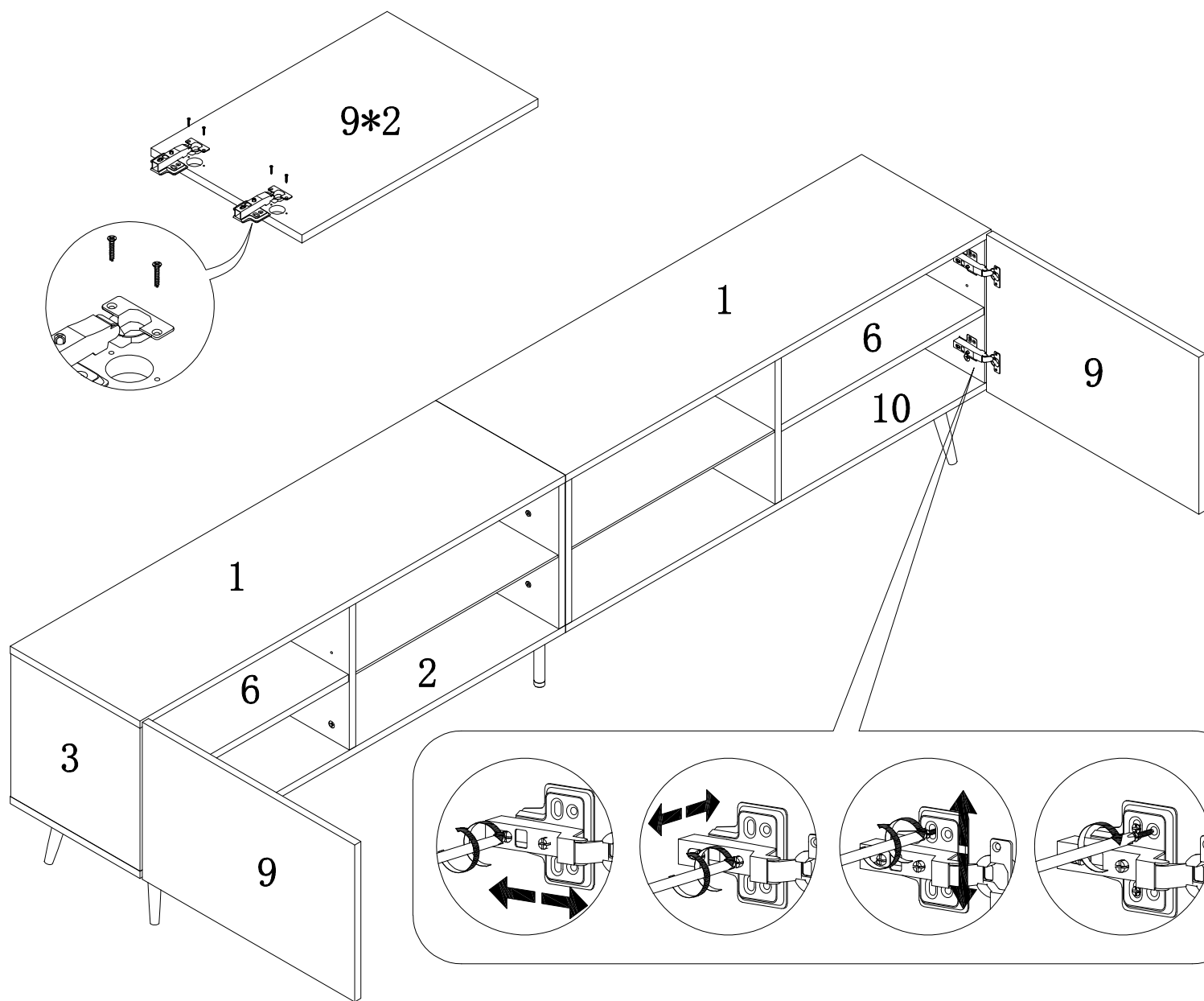
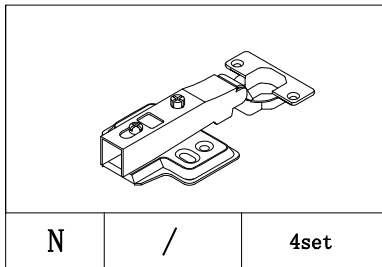

STEP 10

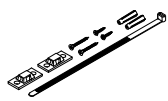

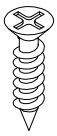
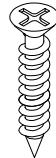
STEP 11

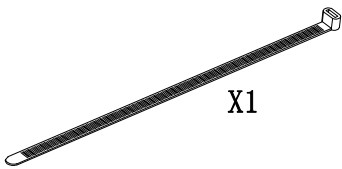
			 X2	 X2	 X2	 X2	 X1
P	/	1set				1set	

