

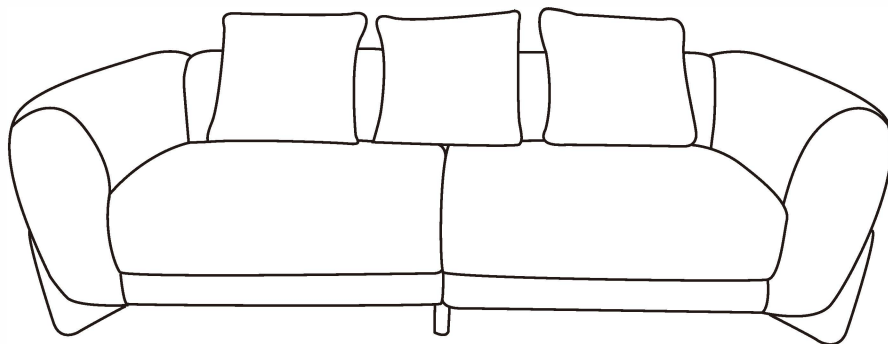

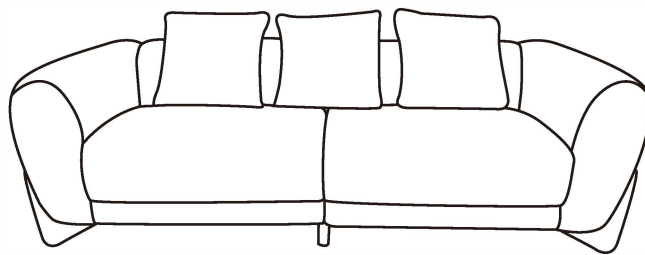







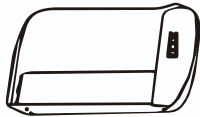







CLOUD SOFA

**ASSEMBLY
INSTRUCTIONS**



ASSEMBLY INSTRUCTIONS



ID	PARTS IDENTIFICATION	QTY	Carton	ID	HARDWARE PACKAGE	QTY
A1	 LEFT ARM	1 PC	CLOUD-ARM	①		2 PCS
				②	M6*20mm SCREWS 	9 PCS
③	M8*60MM SCREWS 	9 PCS				
④	ALLEN KEY 	1 PC				
⑤	3*22mm WASHER 	9 pcs				
⑥	MIDDLE LEG 	2 PCS				
⑦	M8*80MM SCREWS 	9 PCS				
⑧	M8 NUT 	9 PCS				
⑨	φ15mm SPRING SHIM 	9 PCS				
⑩	3*17mm WASHER 	9 PCS				
⑪	ALLEN KEY 	1 PC				
B1	 LEFT BACK FRAME	1 PC	CLOUD- S1-LAF CHAIR	⑫		2 PCS
C1	 LEFT SEAT	1 PC				
B2	 RIGHT BACK FRAME	1 PC	CLOUD-S2-RAF CHAIR	⑫		2 PCS
C2	 RIGHT SEAT	1 PC				

Step 1

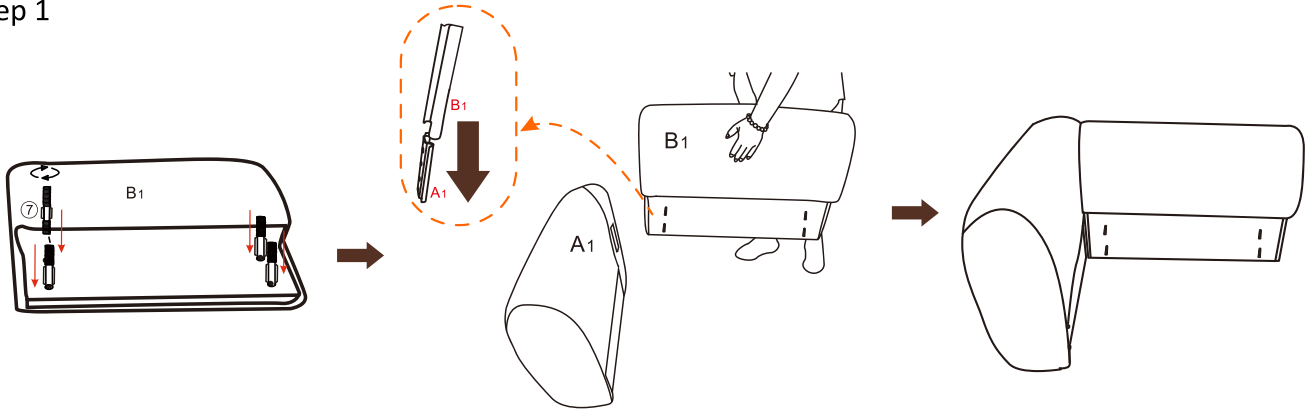

Step 2

"Assemble the bench on a soft, scratch-free surface (e.g., a carpet), then tighten the seat back screws with a hex wrench after assembly."

Step 3

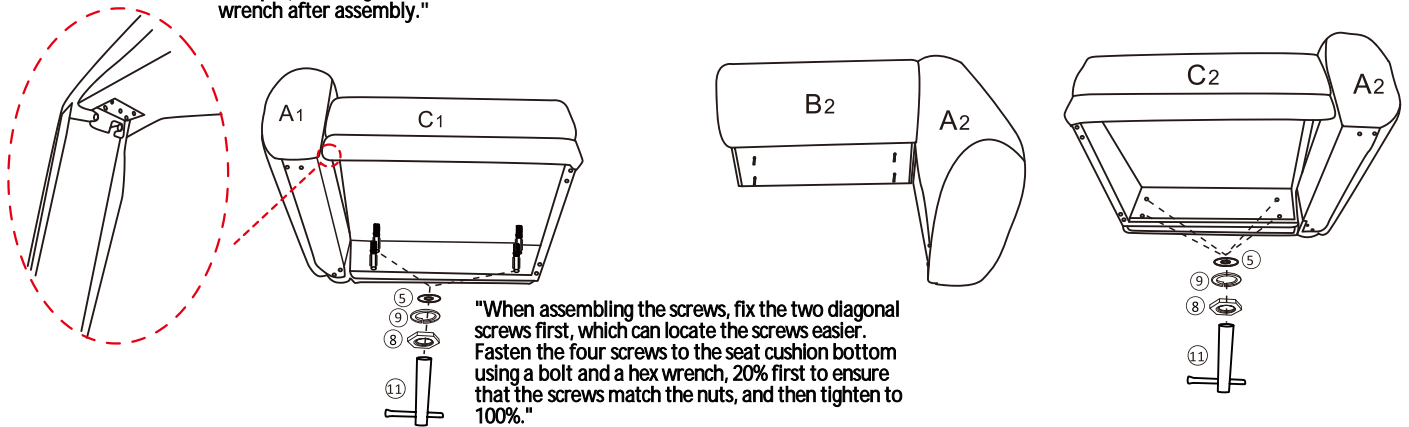

Step 4

"Pre-assemble the center leg screws but do not tighten them yet."

"Insert the bracket halfway first and leave some space. After locating the position of the screws, fix the bracket firmly and tighten the screws."

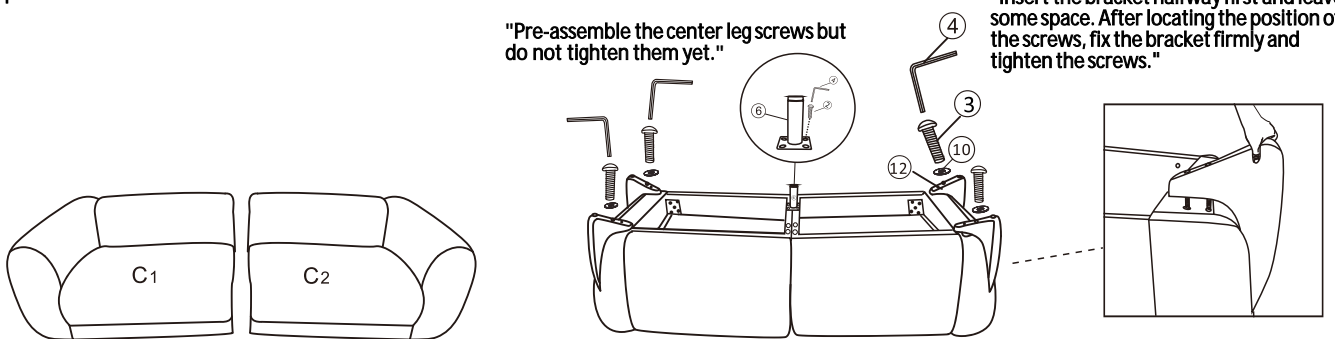

Step 5

"Pre-assemble the screws (1) but do not tighten them yet."

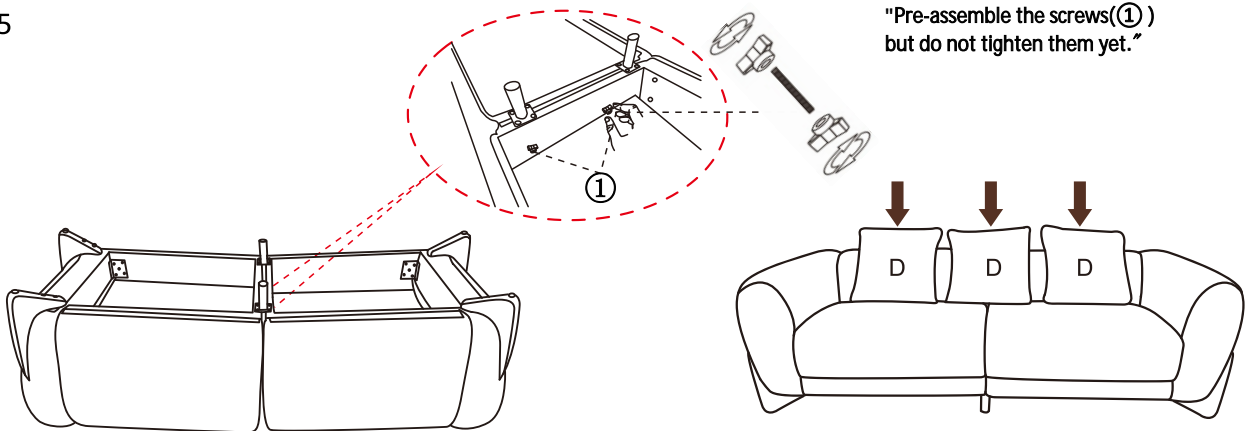

"First tighten all center leg screws in order, then proceed to tighten all screws (1)."







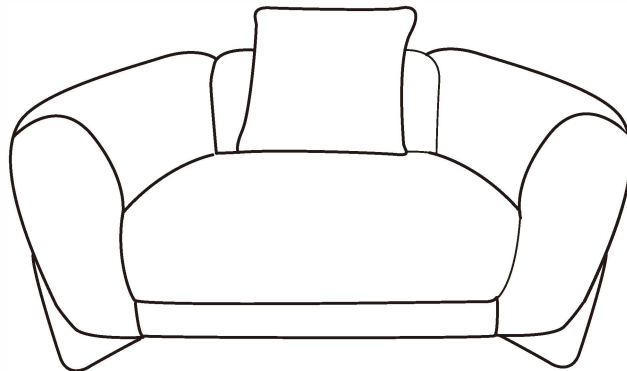

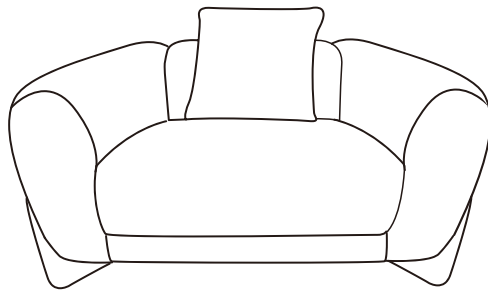

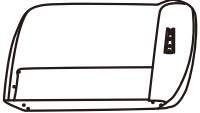
"

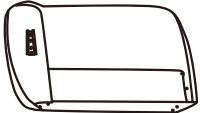
CLOUD CHAIR

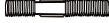
**ASSEMBLY
INSTRUCTIONS**



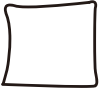

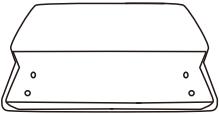
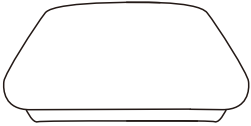
ID	PARTS IDENTIFICATION	QTY	Carton	ID	HARDWARE PACKAGE	QTY
A	 LEFT ARM	1 PC	CLOUD-ARM		M8*60MM SCREWS 	9PCS
					ALLEN KEY 	1PC
B	 RIGHT ARM	1 PC			3*22mm WASHER 	5PCS
					M8*80MM SCREWS 	5PCS
					M8 NUT 	5PCS
					φ15mm SPRING SHIM 	5PCS
					3*17mm WASHER 	9PCS
E	 PILLOW	1 PC			ALLEN KEY 	1PC
					 LEG	4PCS
C	 BACK FRAME	1 PC		CLOUD CHAIR		
D	 SEAT	1 PC				

Step 1

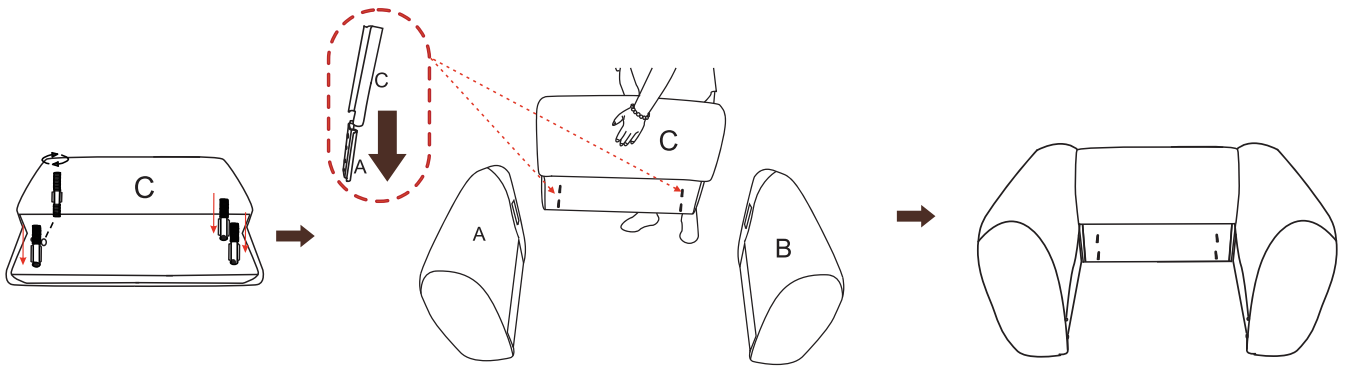

Step 2

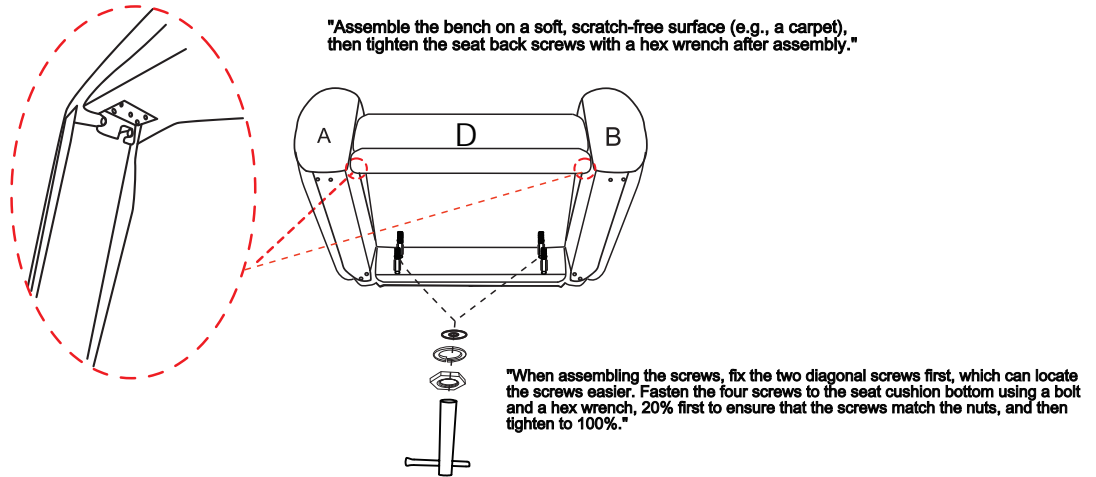

Step 3

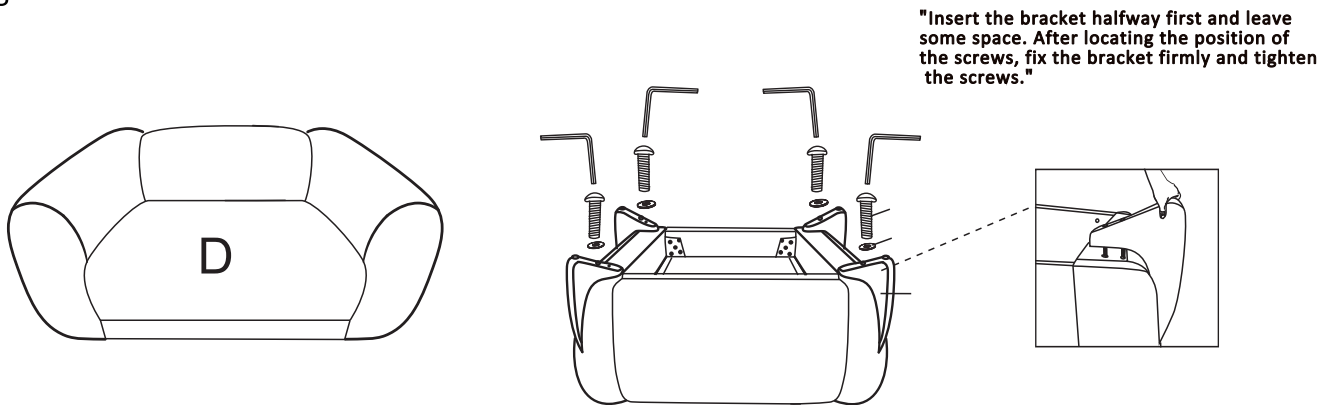

Step 4

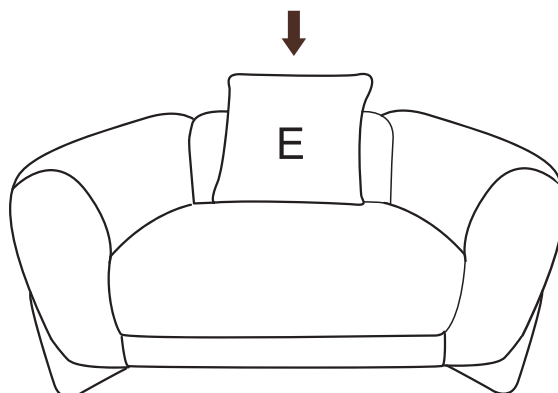

ITEM: CLOUD SOFA SET

ASSEMBLY INSTRUCTIONS

ASSEMBLY TIPS

1. Remove hardware from box and sort by size.
2. Please check to see that all hardware and parts are present prior to start of assembly.
3. Please follow attached instructions in the same sequence as numbered to assure fast & easy assembly.



WARNING!

1. Don't attempt to repair or modify parts that are broken or defective. Please contact the store immediately.
2. This product is for home use only and not intended for commercial establishments.

ASSEMBLY TIME: 45 MINUTES

