

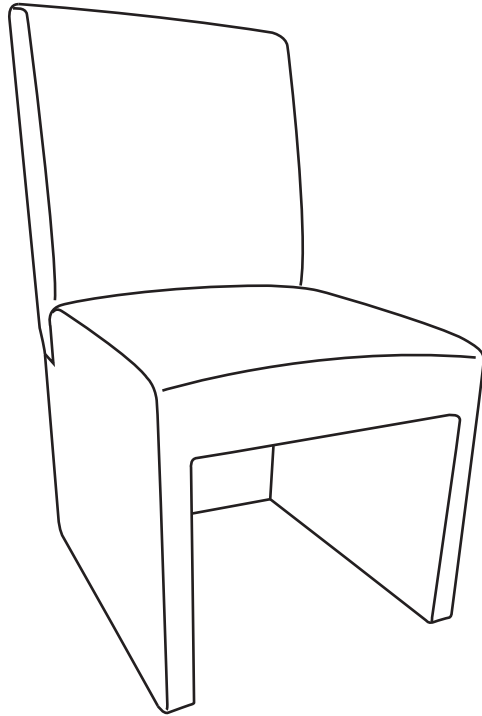

SKU:BR-008



cd.service001@gmail.com

We Make Beautiful Chair



Safety Information

- **Do not completely tighten screws until all screws are started.** Tighten each bolt firmly and properly.
- Some parts may contain sharp edges. Wear protective gloves as necessary.
- Children under the age of 16 should not be engaged in the assembly, removal or disassembly of the product. Children under the age of 10 should be supervised by a competent adult while using this furniture.
- Please keep children out of the assembly area during assembly.
- Never use this product as a support. Do not shake, lean, or climb on the product at any time.

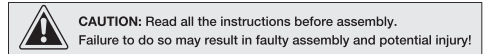
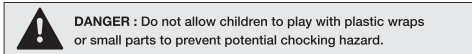

Warranty

LIMITED WARRANTY

This warranty is a limited warranty, and applies to the original purchase is required. This is a residential warranty and does not apply to commercial use. This collection carries a (1) year limited warranty and is valid from original date of purchase to the original owner (proof of purchase required).

WHAT IS COVERED

We warrant the frame to be free of Manufacturing defects to the original purchaser for one year.

WHAT IS NOT COVERED

This warranty does not cover commercial use, hardware, acts of nature, fire, freezing and abusive. In addition, purchased parts are not covered under this warranty.

We reserve the right to make substitutions with similar merchandise, if the model in question is no longer in production.

For a copy of our full limited warranty, please contact our customer service team.

Cleaning and Maintenance

- Clean the furniture with damp cloth, rinse thoroughly. Dry frame parts completely. Do not use bleach, acid or other solvents on the textile or metal parts.
- We recommend the use of furniture covers to protect the product when not in use.
- Inspect and tighten all screws on a regular basis to ensure proper performance and safety.
- In order to prolong the life and beauty of your product, we recommend storing it in a dry and protected area during off season periods.

WARNING

Please read the instructions carefully and follow the assembly steps.



**SAFETY AND
CARE ADVICE**



NO POWER TOOLS

ASSEMBLY PARTS AND TOOL

A

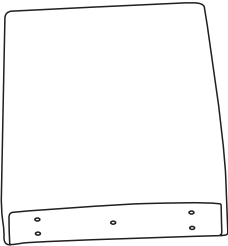

1PC

B

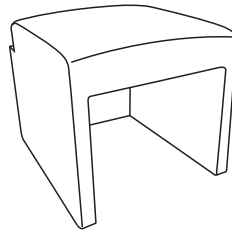

1PC

C



5PCS

D



5PCS

E



5PCS

F



1PC

G



4PCS

Assembly

STEP 1 Place Parts (A) & (B) on a clean & flat surface. Tighten 100% secure for Screws (C) & Spring washers (D) & Flat Washers(E) by Wrench (F). Insert Foot pegs (G) into the bottom of chair . (If the chair is uneven, you can also adjust the Foot pegs (G) at the bottom of the chair to improve balance.)

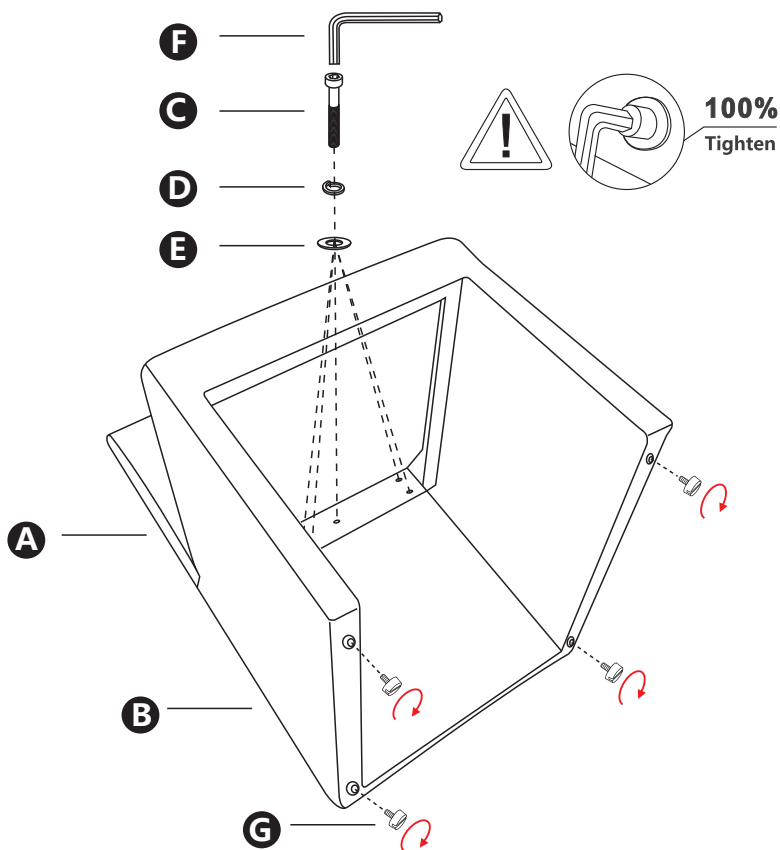

Assembly

STEP 2 Your chair assembly is complete!

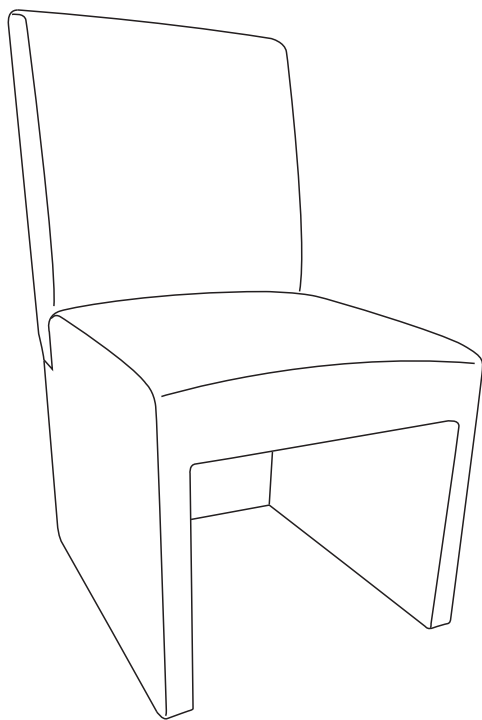



If you need help or have damaged
or missing parts, please don't worry!
Just reach out to our online
customer service team at
cd.service001@gmail.com