

**IMPORTANT - READ CAREFULLY
RETAIN FOR FUTURE REFERENCE**

4'0 TAURUS BED LOW FOOT END Assembly Instructions

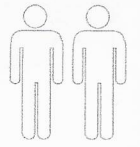

1:30min

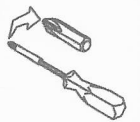

Do Not Use Power Tools

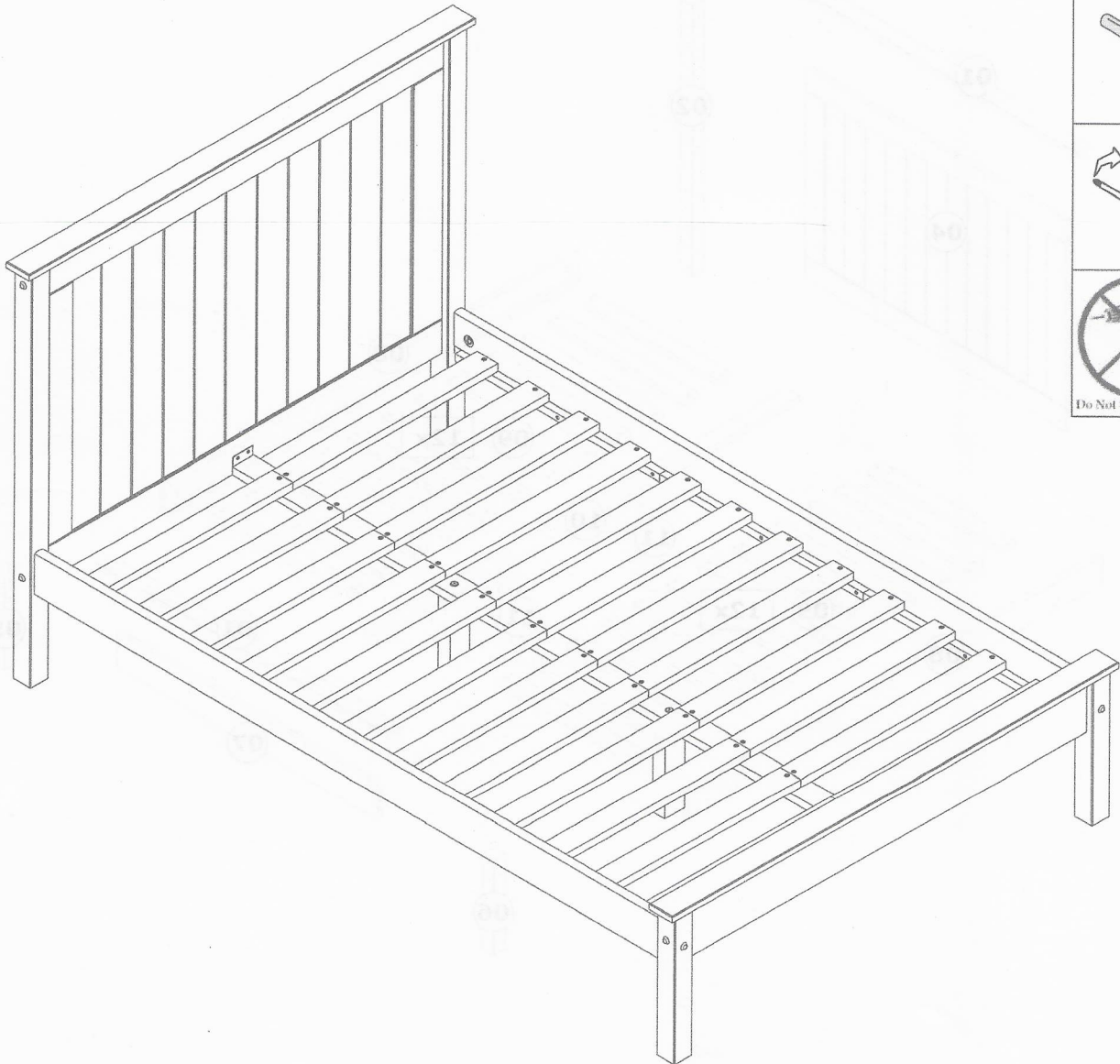





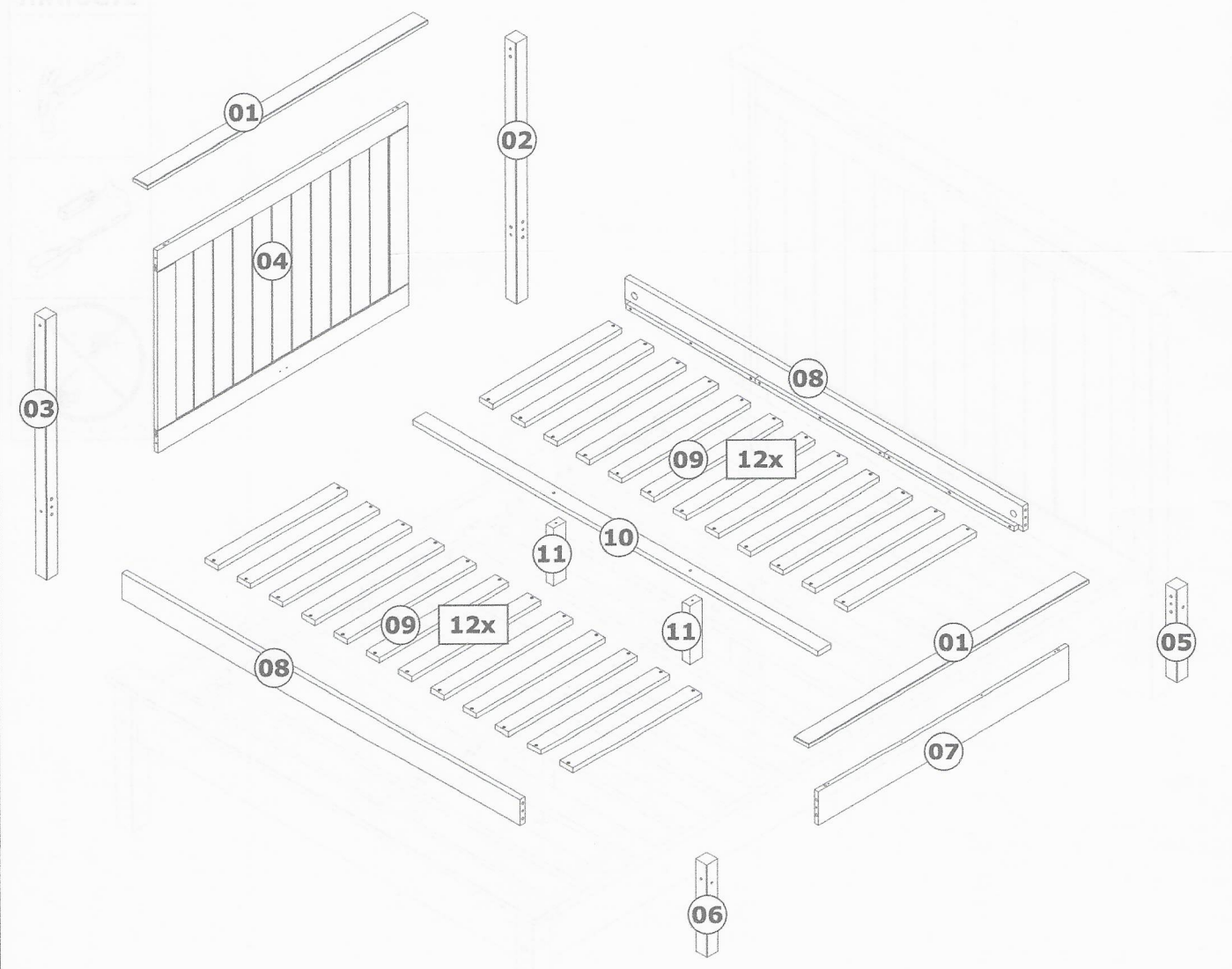
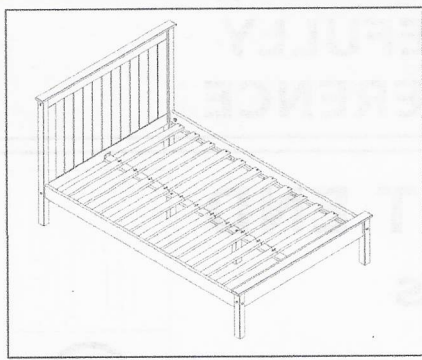

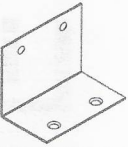
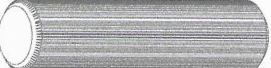

BATCH: 23/0025
PROFORMA: 2023/0206
ORDER: 2386

PARTS.:

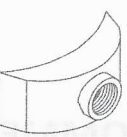
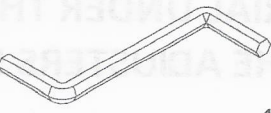

BATCH: 239025
 PROGRAM: 2023/0208
 ORDER: 288

4'0 TAURUS BED LOW FOOT END HARDWARE

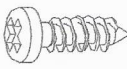
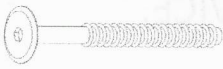
A	 Ø8x30mm	04	L	 CT 26	02
B	 Ø10x40mm	16	X	 spacer	02
C	 Ø1/4"x100mm - Cab. Ø17mm	04			
D	 Ø7x90mm - Cab. Ø17mm	06			
E	 Ø3,5x30mm	08			
F	 Ø4,0x35mm	48			
G	 Ø1/4"x25mm	04			
H	 4mm	01			
I		10			
J	 Ø3,5x16mm	08			
K	 Ø7,0x60mm - Cab. Ø17mm	02			

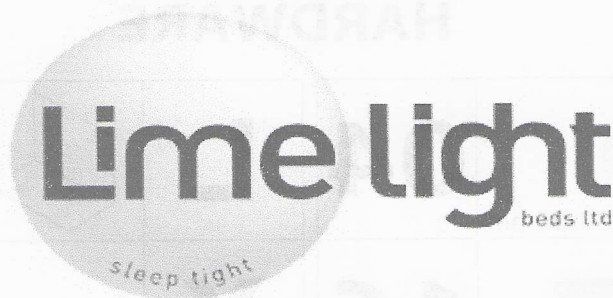

BEDS WITH CENTRE LEGS

PLEASE NOTE THE RECOMMENDED PROCESS FOR ADJUSTING CENTRE LEGS WHEN ASSEMBLING YOUR BED.

BEFORE PLACING THE MATTRESS ON THE BASE, PLEASE ENSURE THAT THE SUPPORT LEGS ARE NOT QUITE TOUCHING THE FLOOR. WHEN THE BED IS THEN IN USE THE SUPPORT LEGS WILL SIT FIRMLY ON THE SOLID SURFACE.

PLEASE ENSURE THAT THE LEGS ARE VERTICAL

DUE TO THE NATURE OF LAMINATE FLOORING WE RECOMMEND THAT YOU PLACE A SMALL PIECE OF NON SLIP MATERIAL UNDER THE LEGS WHICH WILL GIVE YOU THE FLEXIBILITY THAT THE ADJUSTERS NEED.

WHEN MOVING THE BED IT IS ESSENTIAL THAT IT IS LIFTED INTO THE NEW POSITION. NEVER DRAG THE BED AS THIS WILL MOVE THE LEGS FROM THE VERTICAL POSITION THUS WEAKENING THE SUPPORT OF THE CENTRE RAIL.

ADHERING TO THE RECOMMENDED PROCESS SHOULD ENSURE THAT YOUR BED GIVES YOU YEARS OF TROUBLEFREE SERVICE.

THANK YOU

PROBLEMS?

SHOULD YOU ENCOUNTER ANY DIFFICULTY WITH THE ASSEMBLY OF YOUR BED, PLEASE DO NOT TROUBLE YOUR RETAILER BUT

CALL, FAX, E-MAIL or WRITE to our
CUSTOMER SERVICES DEPARTMENT
BETWEEN THE HOURS OF
9.00am to 5.00pm MONDAY to THURSDAY
and
9.00am to 4.00pm FRIDAY

Tel : 01455 850 150

Fax: 01455 848 169

Email: info@limelightbeds.co.uk

Limelight Beds Ltd

Orbital House

Arthur Street

Barwell

Leicestershire

LE9 8GZ

Please have the following information ready for our staff

- Product Name

- Part Number

see our range on website:

www.limelightbeds.co.uk

CARING FOR YOUR NEW LIMELIGHT PRODUCT

- ✍ **PLEASE NOTE : GOODS THAT NEED TO BE RETURNED SHOULD BE SENT BACK IN ITS ORIGINAL PACKAGING.**
- ✍ When assembling your bed, please ensure that you have checked the contents for all relevant parts.
- ✍ When tightening bolts, do make sure that they are fully tightened but not forced.
- ✍ When moving your fully assembled bed, you must first remove the mattress and lift the frame into position; taking care when lifting and always have two people handling the bed. **PLEASE DO NOT DRAG THE BED** as this will cause damage to the central support legs and rail. Central legs **MUST** be in a vertical position at all times.
- ✍ Due to the nature of laminate flooring, we recommend that you place non-slip material under the central support legs. This will stop the legs from sliding on laminate/wooden floors and will prevent the bed from collapsing.
- ✍ It is advisable to use approved cleaning products when cleaning the furniture and bed frame as certain chemical -based cleaners could have an adverse effect on the bed's finish.
- ✍ All Limelight beds are produced to the highest standards and are packed to avoid damage in transit. Should you find that your new bed does not meet your satisfaction, please contact Limelight's Customer Services Department at 01455 850 150.

01

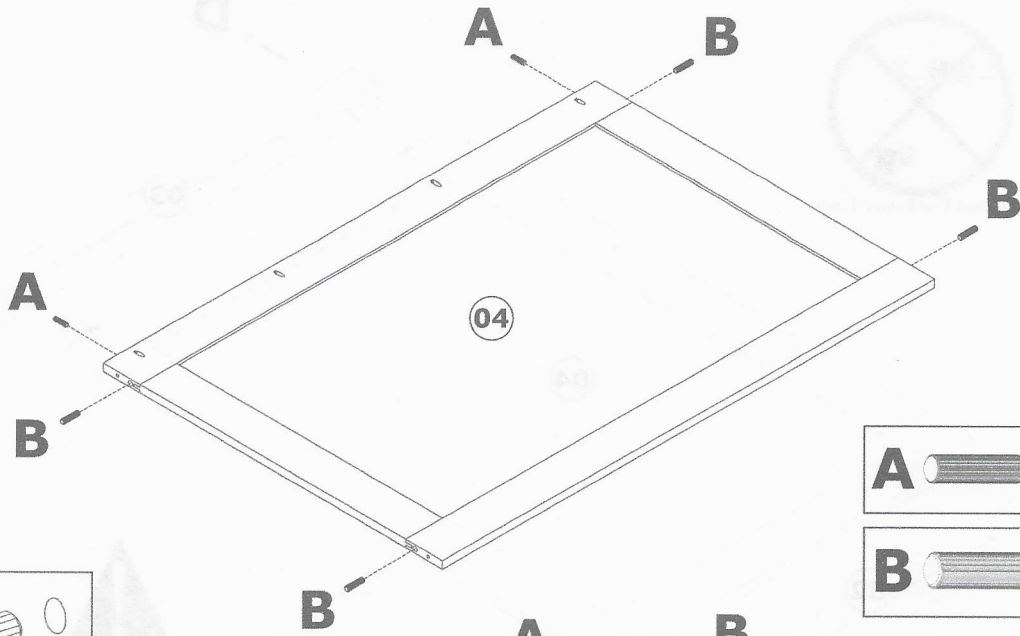

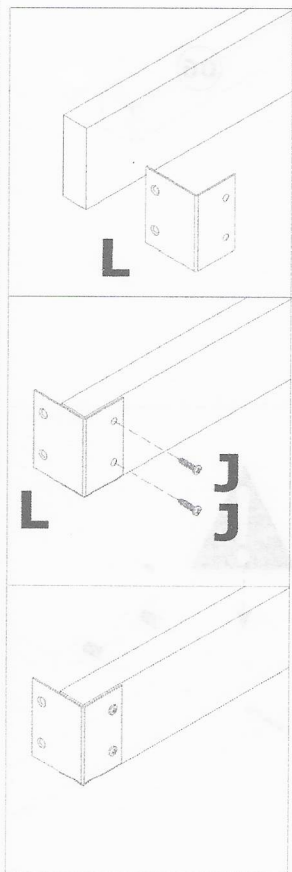
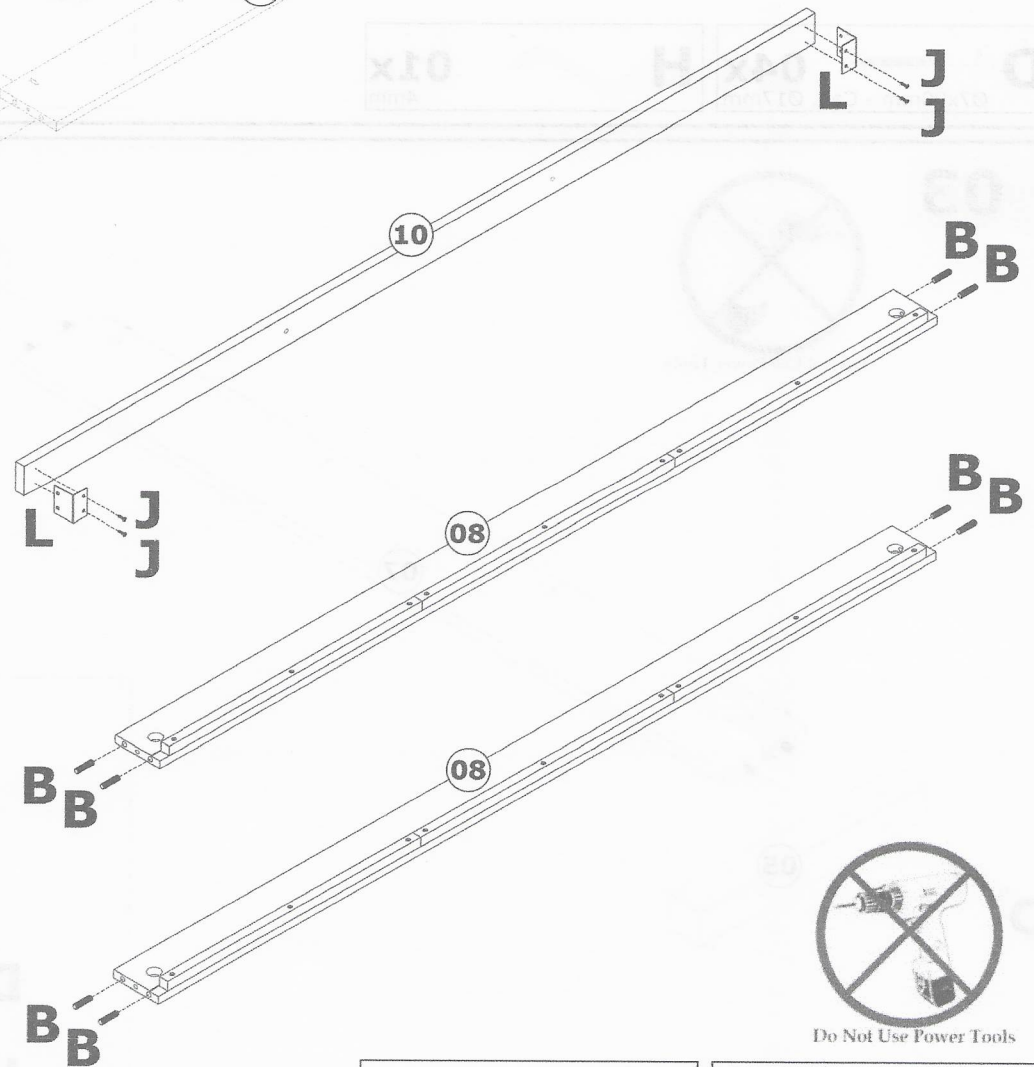
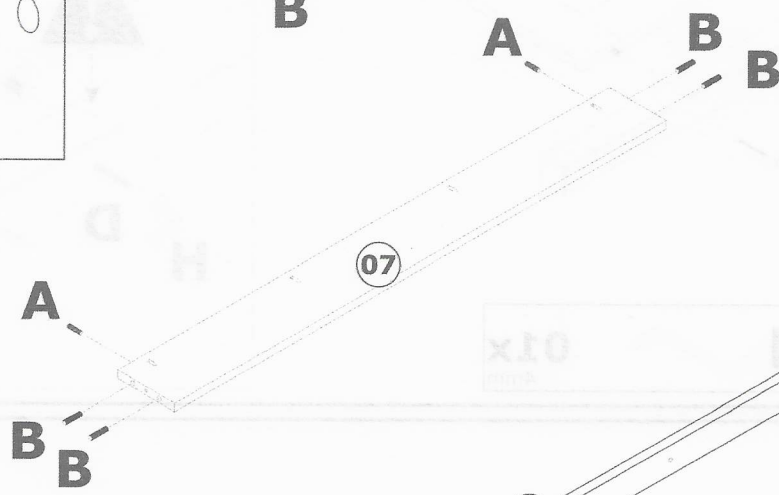
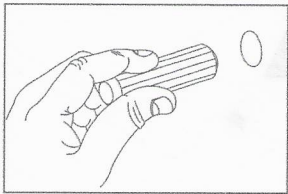

A  **04x**
Ø8,0x30mm

B  **16x**
Ø10x40mm



Do Not Use Power Tools

J  **04x**
Ø3,5x16mm

L  **02x**
CT26

02



Do Not Use Power Tools

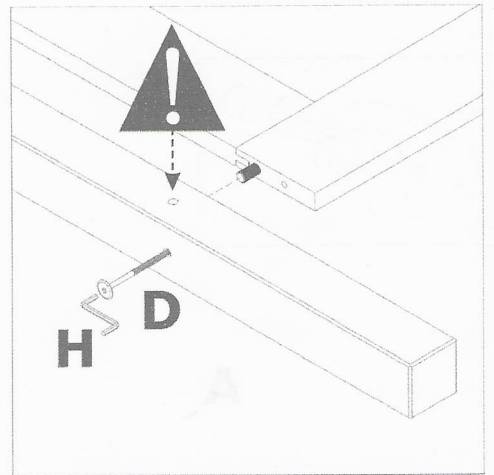
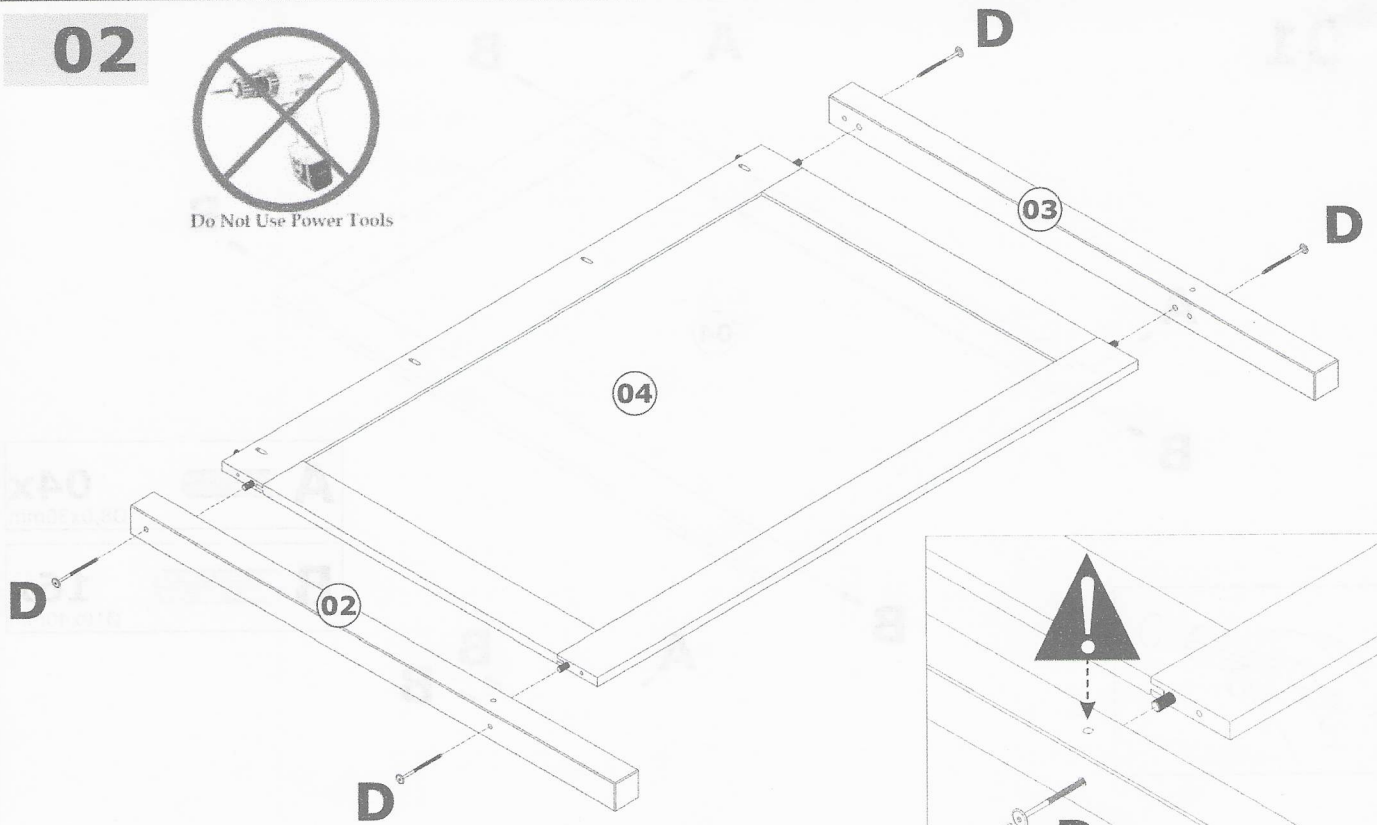

D **04x**
Ø7x90mm - Cab. Ø17mm

H **01x**
4mm

03



Do Not Use Power Tools

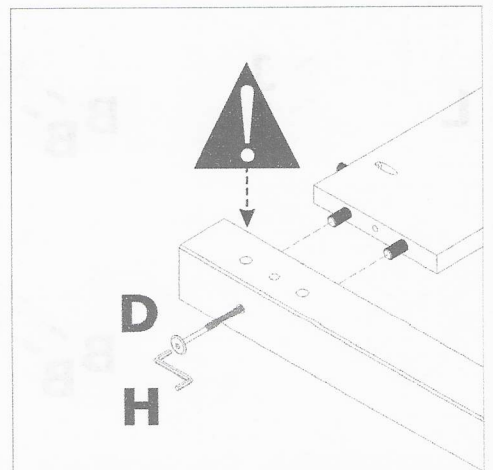
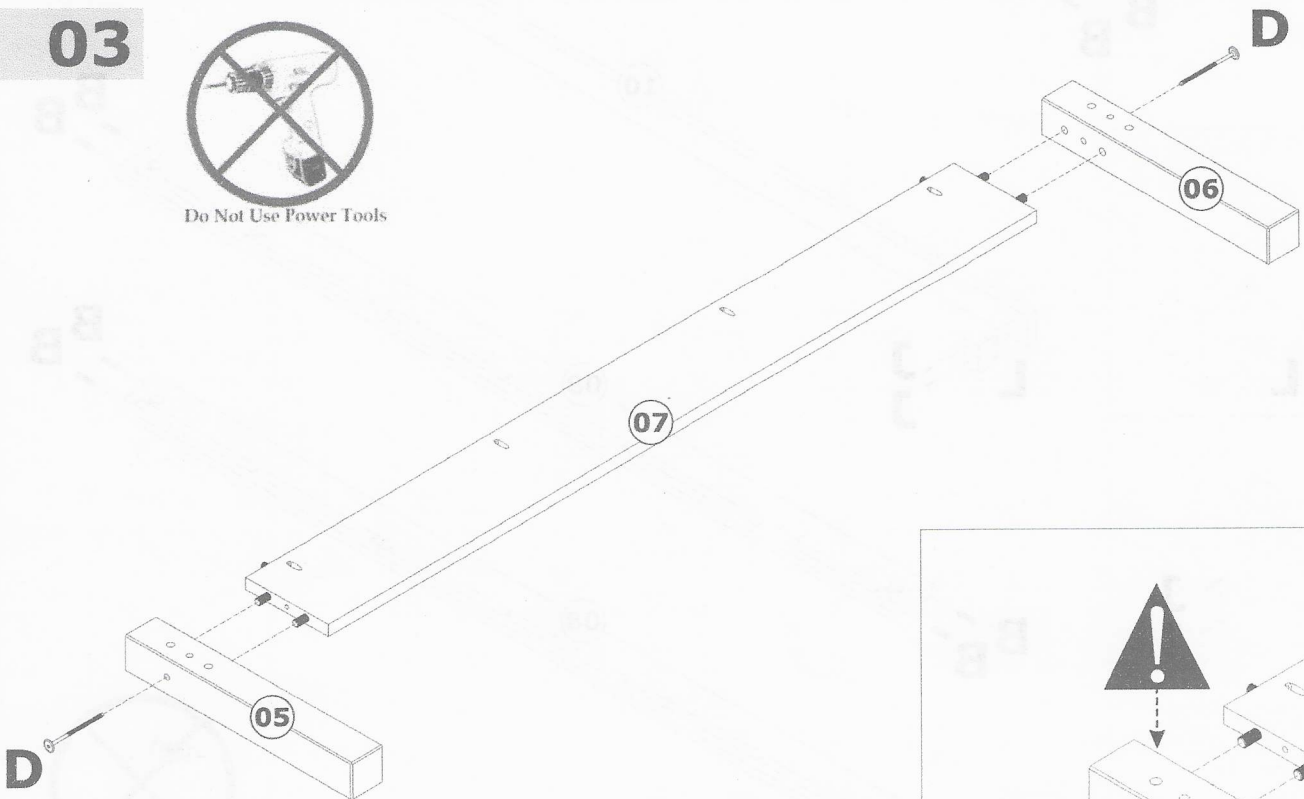

D **02x**
Ø7x90mm - Cab. Ø17mm

H **01x**
4mm

04



Do Not Use Power Tools

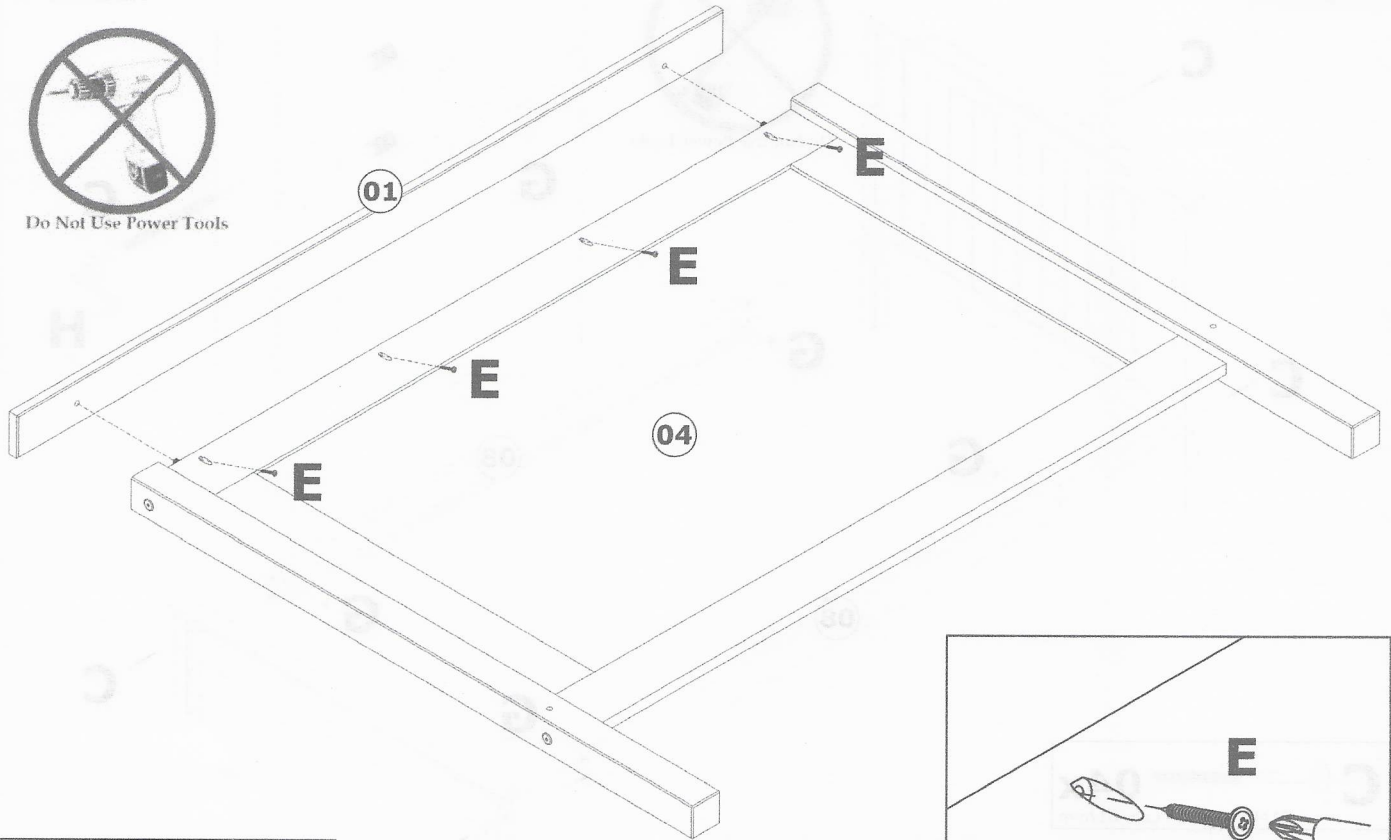

E  **04x**
Ø3,5x30mm

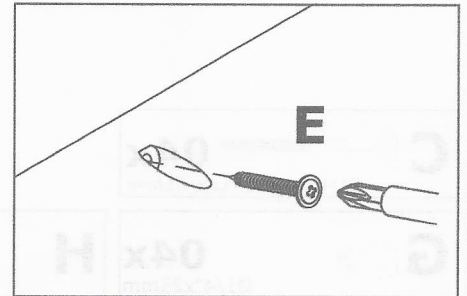

05



Do Not Use Power Tools

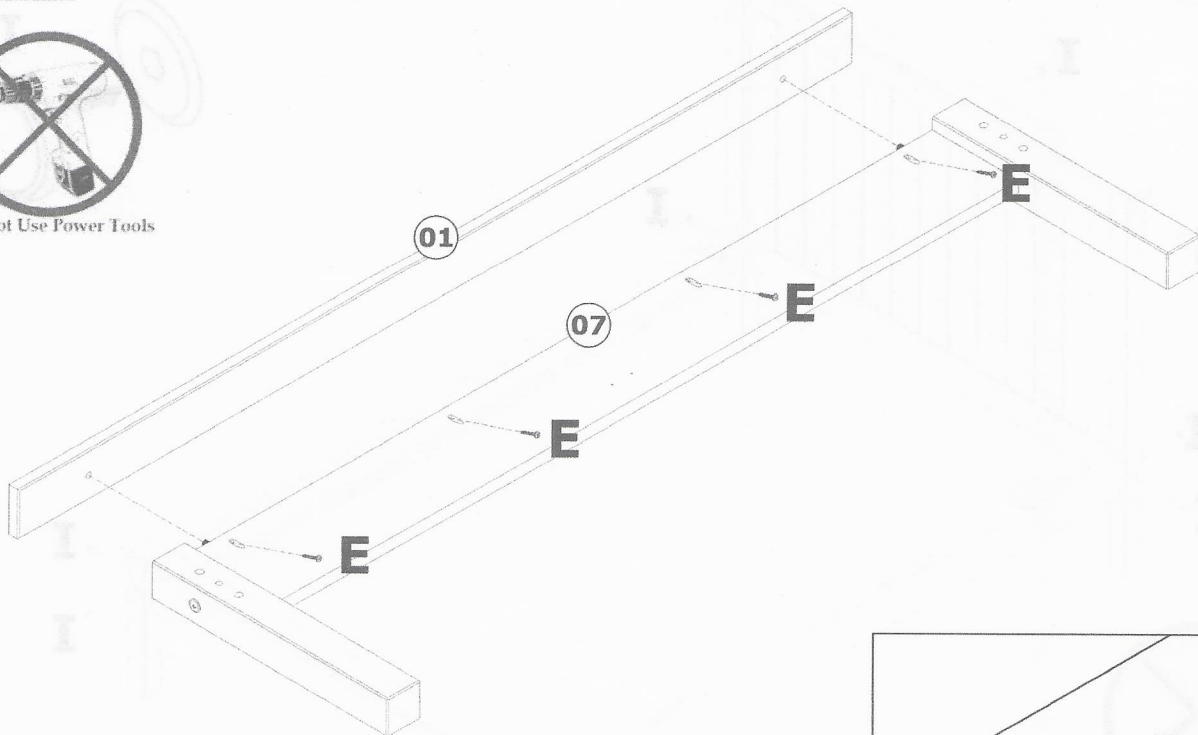

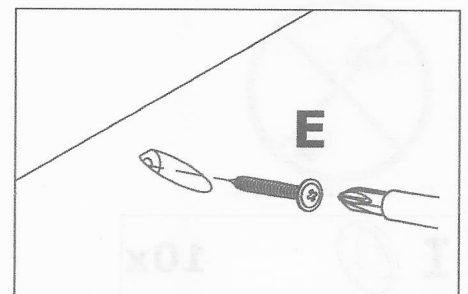

E  **04x**
Ø3,5x30mm

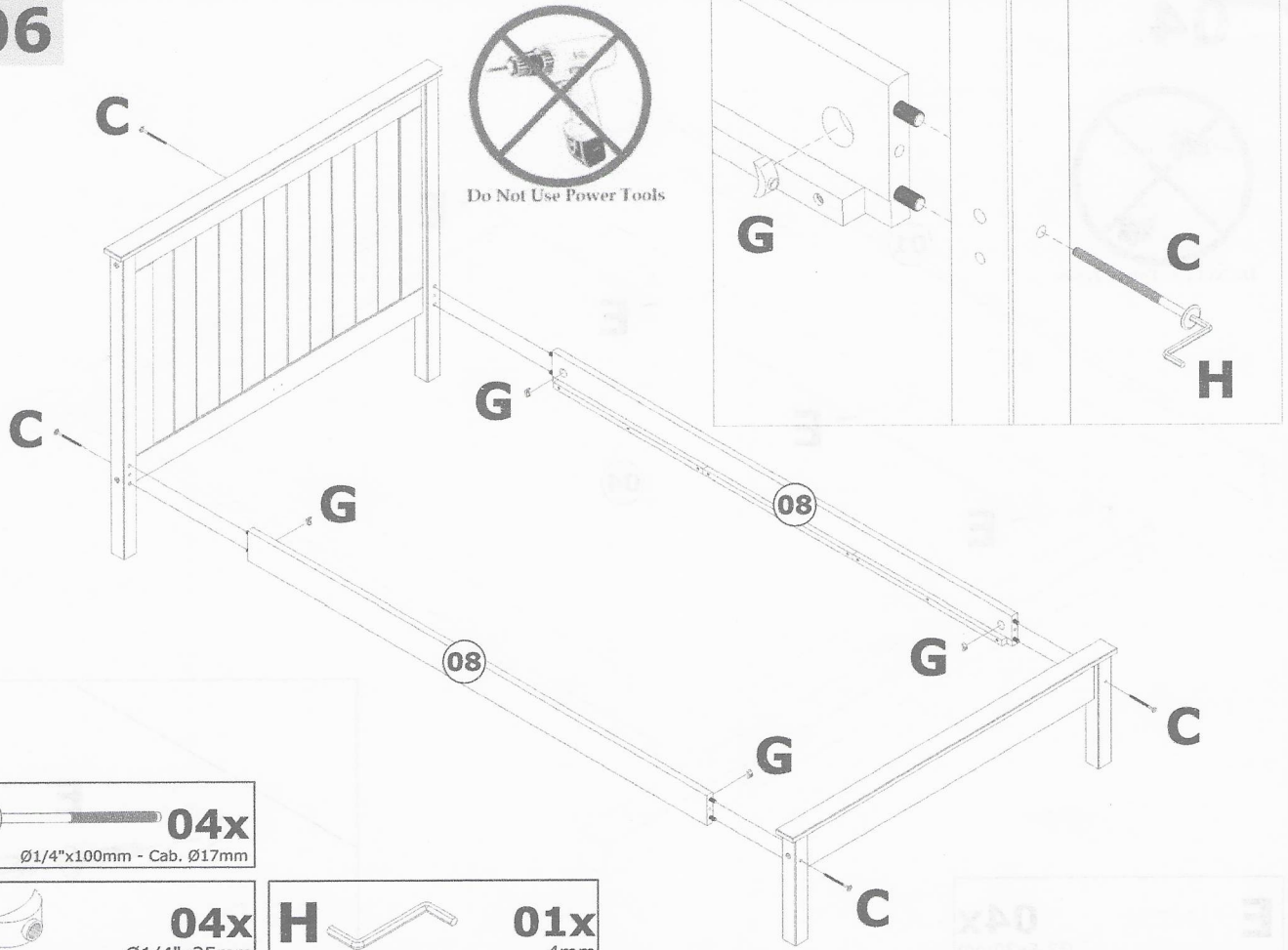

06

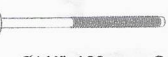



C  **04x**
 Ø1/4"x100mm - Cab. Ø17mm

G  **04x**
 Ø1/4"x25mm

H  **01x**
 4mm

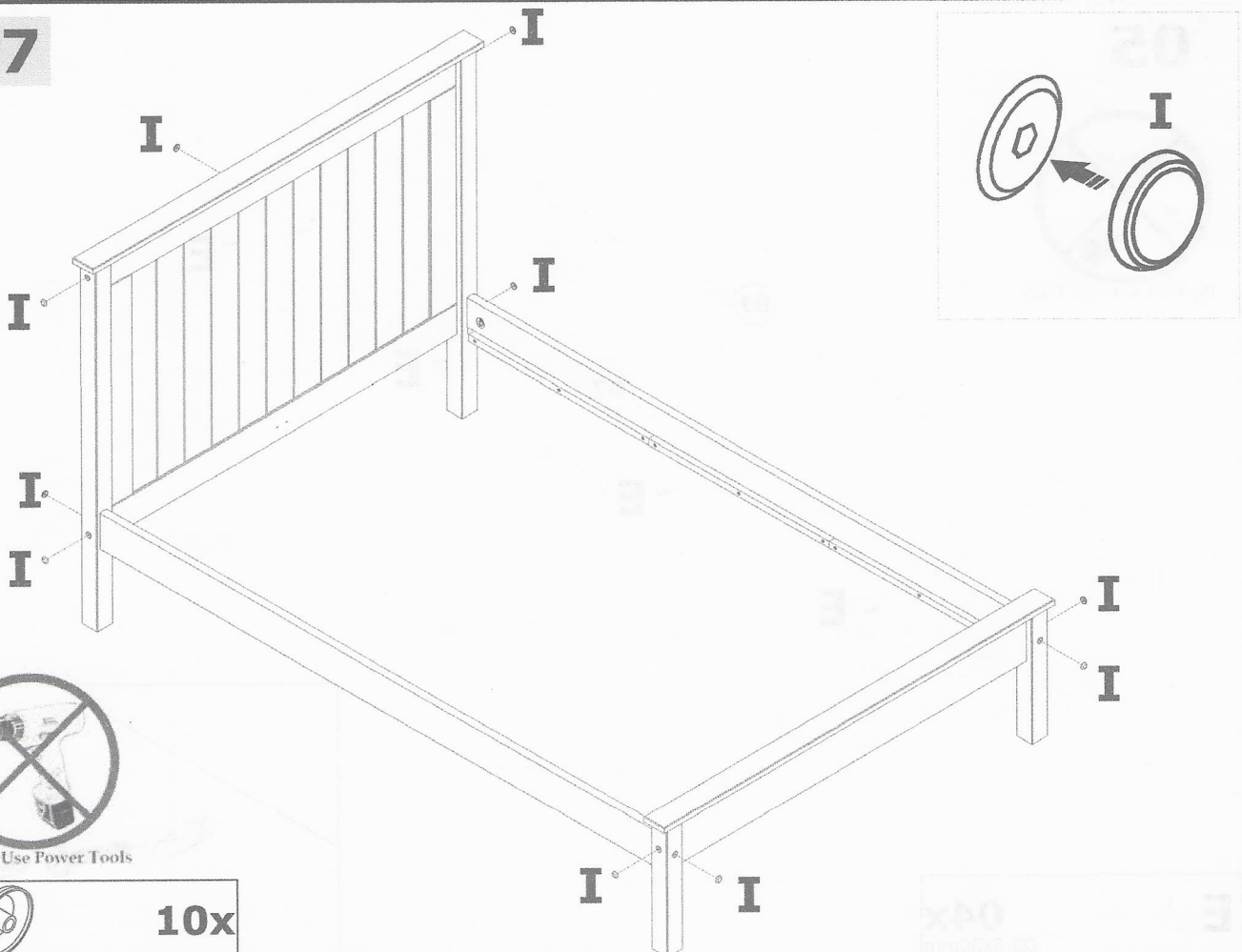
07



I  **10x**

08



01x
4mm

K  02x
Ø7,0x60mm - Cab. Ø17mm

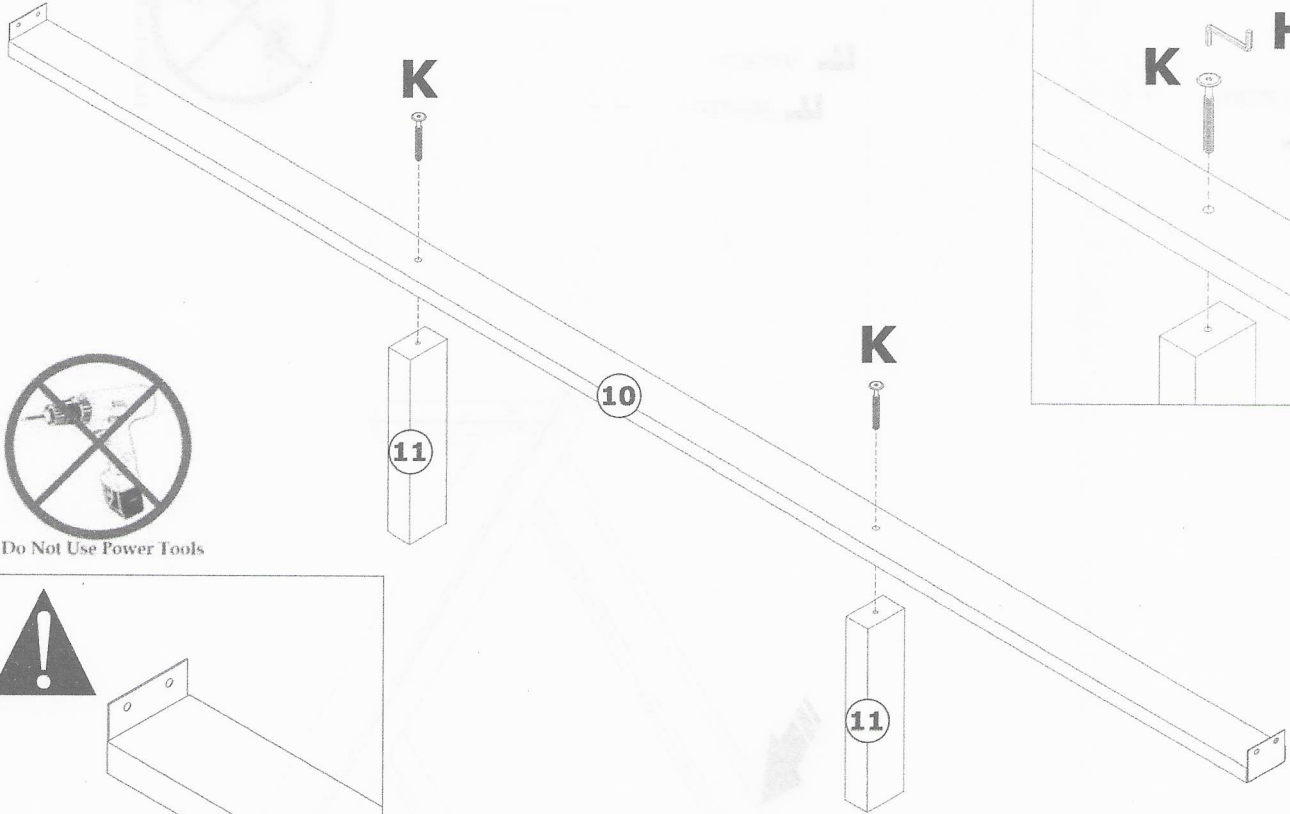
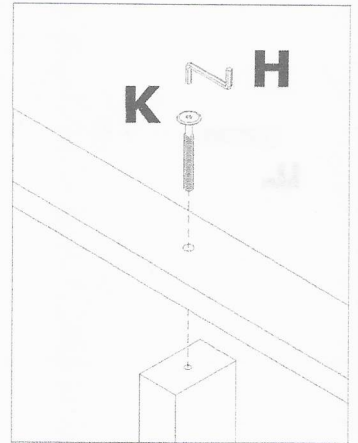

Do Not Use Power Tools

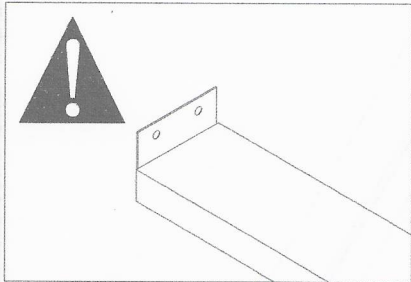

09

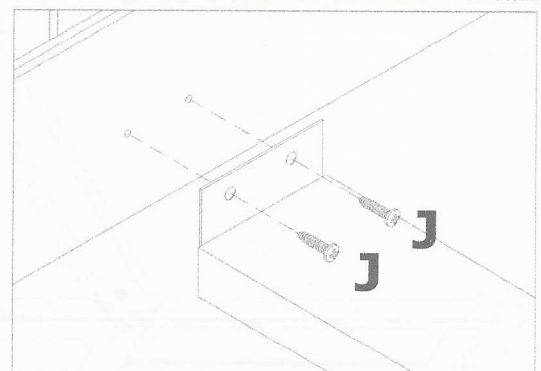
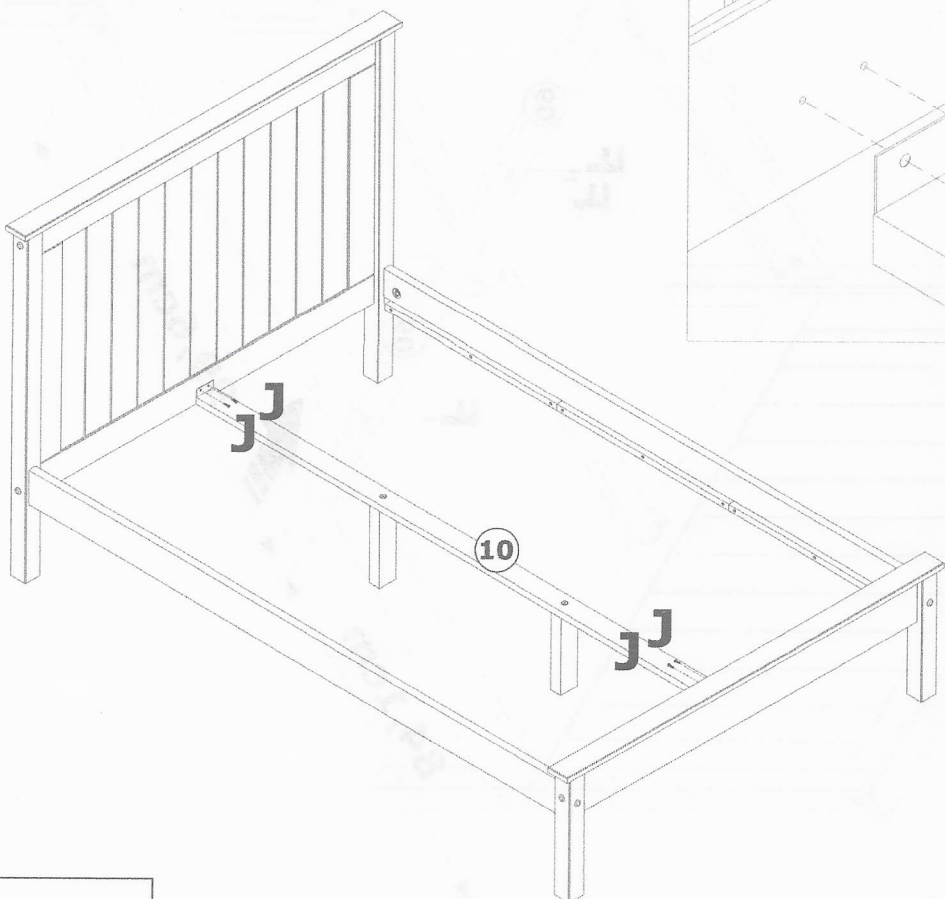

J  04x
Ø3,5x16mm



Do Not Use Power Tools

10

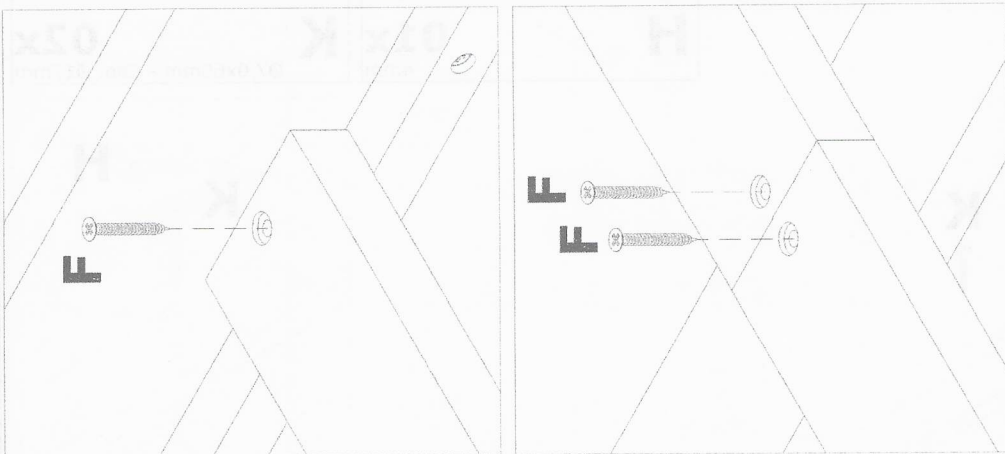
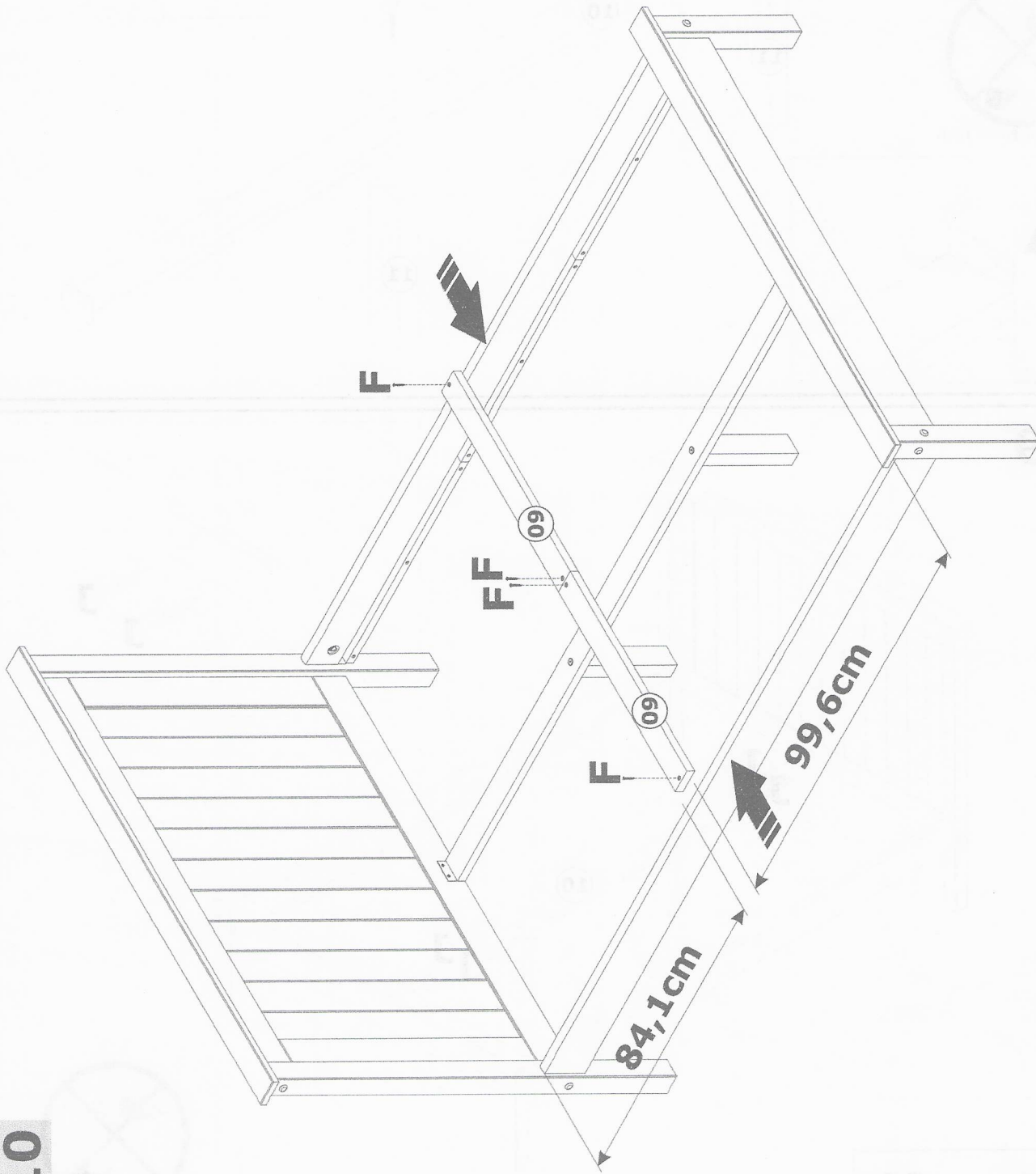

Do Not Use Power Tools

F  **04X**
Ø4,0x35mm

11

F  **44X**
Ø4,0x35mm

X  **02X**
SPACER

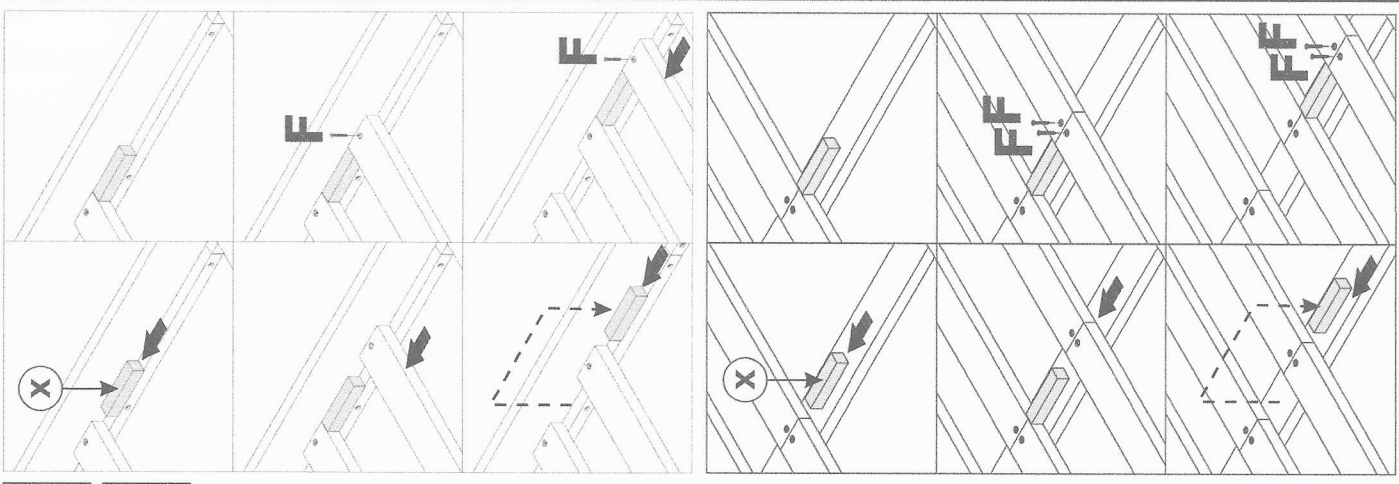
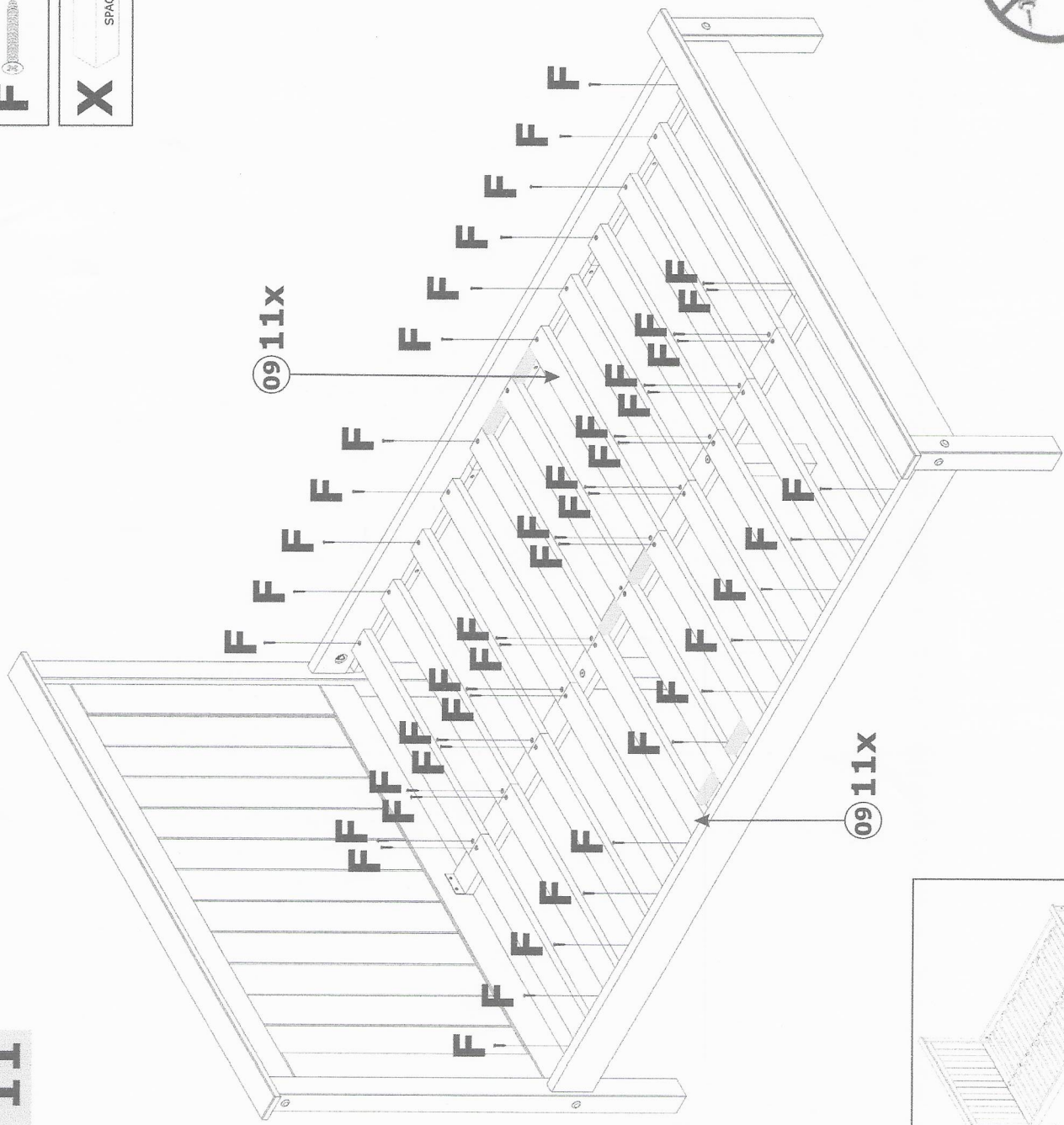

Do Not Use Power Tools

