

# Assembly Instructions

**Caution: You must read this before you proceed.**

## Table

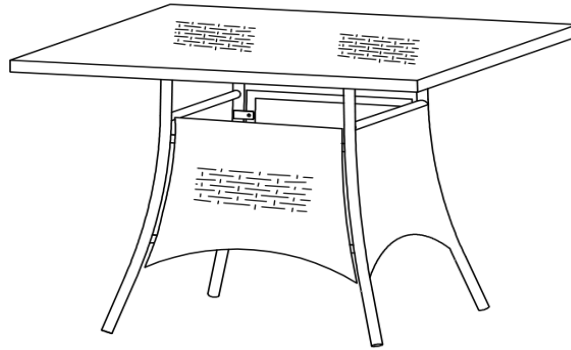

## Parts List

Label	Picture	Description	QTY
A		Table Top	1
B		Leg Panel	2
C		Leg Support Panels	2

## Hardware

Label	Picture	Description	QTY
①		Allen Key	1
②		Bolt M6*20mm	13
③		Washer	13

# Assembly Preparation

Before Beginning Assembly: Unpack all the parts for a clear overview.

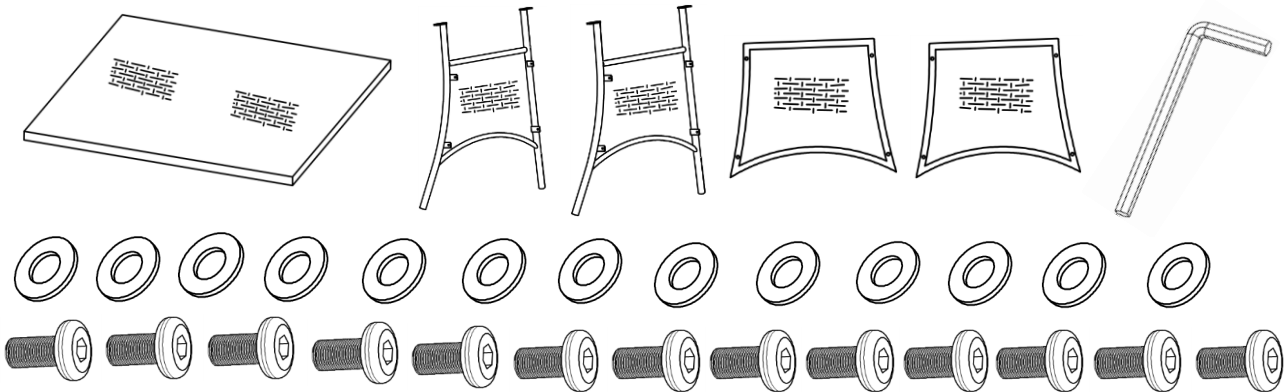

- Read instructions, cover to cover-



- Have 2 adults on hand for assembly-



- Do not assemble on flooring or carpet-



- Assemble on a clean non-marring surface (packing foam)-



- Save all packaging until finished-

# Assembly Steps

## Overview

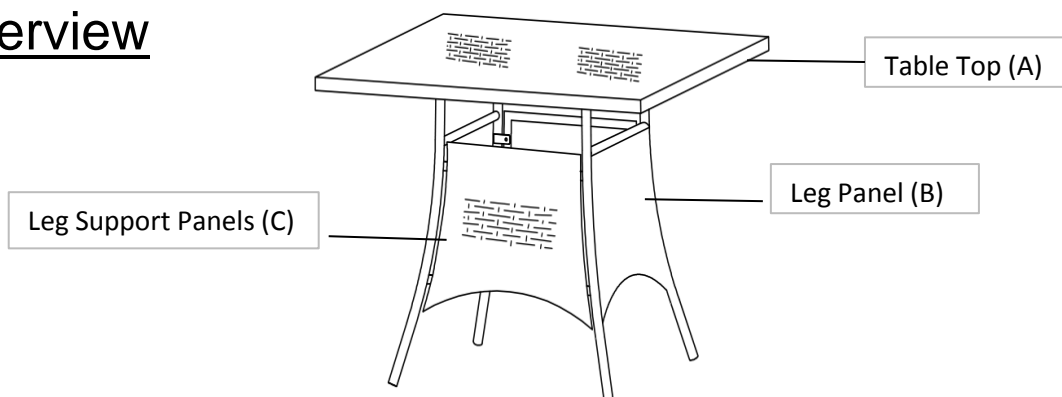

This Table has multiple parts and may require up to some 30 minutes to assemble. To give you an overview of the Table parts, the above picture is to help you put the various parts into perspective. Please read through the instructions below to familiarise yourself with the parts and steps before assembly.

## Step 1

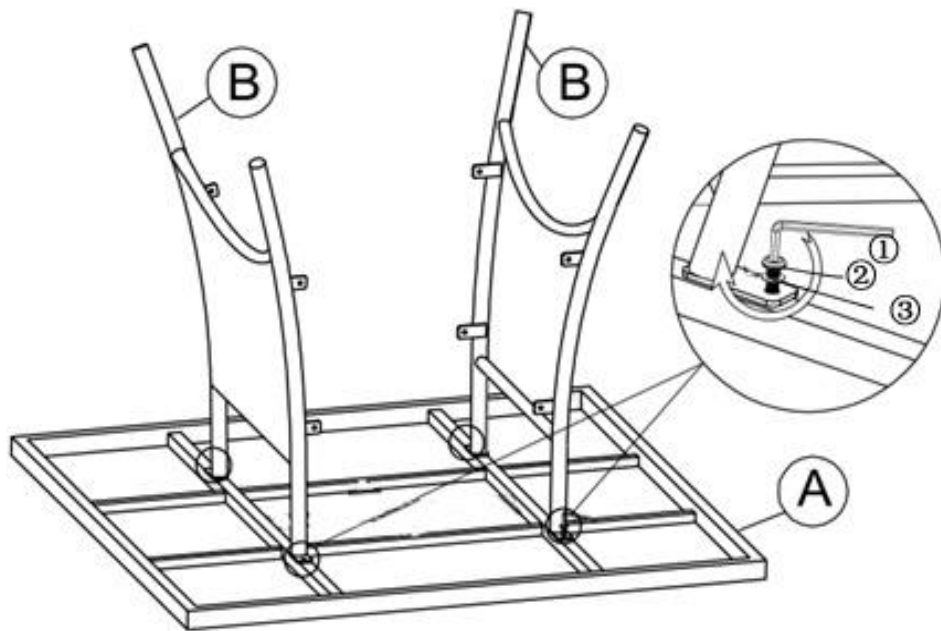

Open the carton and place all the parts on a clean, non-marring surface.  
Turn table top upside down. Attach Leg Panel (B) to the Table Top (A) using Bolt (2) and Washer (3) with Allen Key (1) as shown in the picture above.  
Repeat this process with the other Leg Panel (B)  
**DO NOT FULLY TIGHTEN THE BOLTS.**

## Step 2

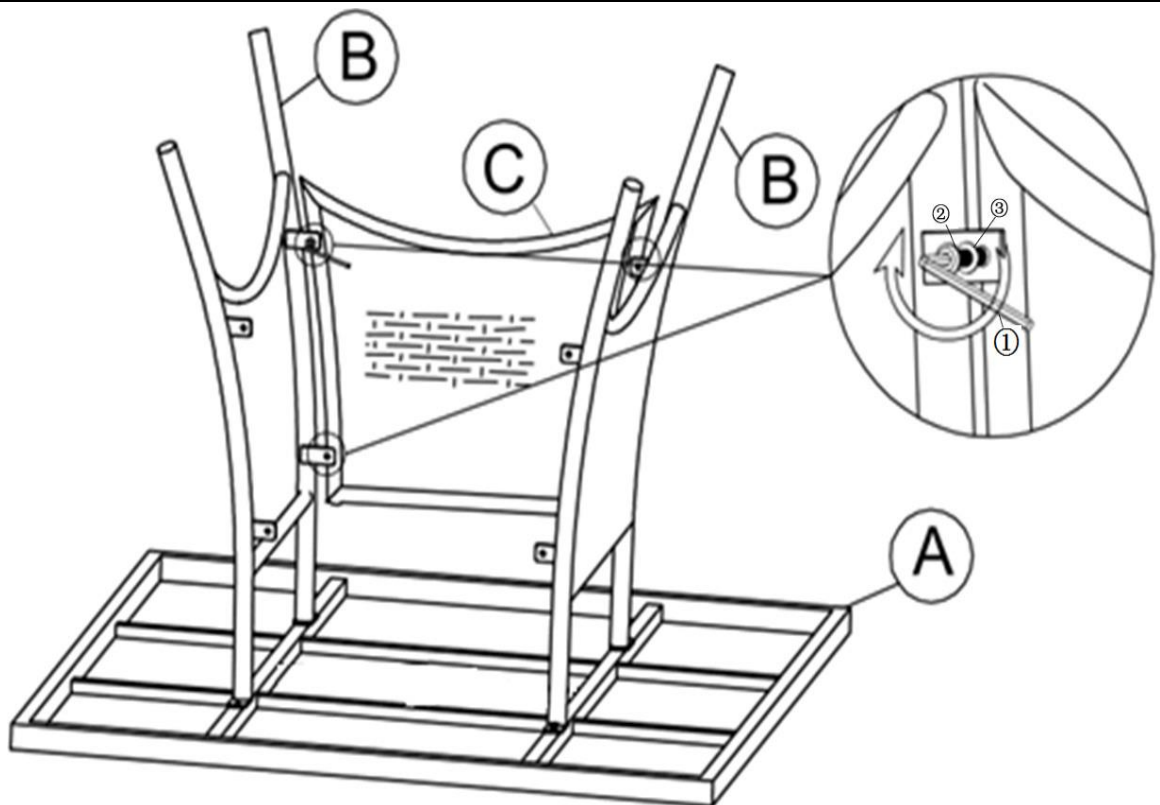

Attach Leg Support Panel (C) between Leg Panels (B) using Bolt (2) and Washer (3) with Allen Key (1) as shown in the picture above.  
Repeat the same process to affix the another Leg Support Panel (C)  
**Tighten the Bolts.**

## Step 3

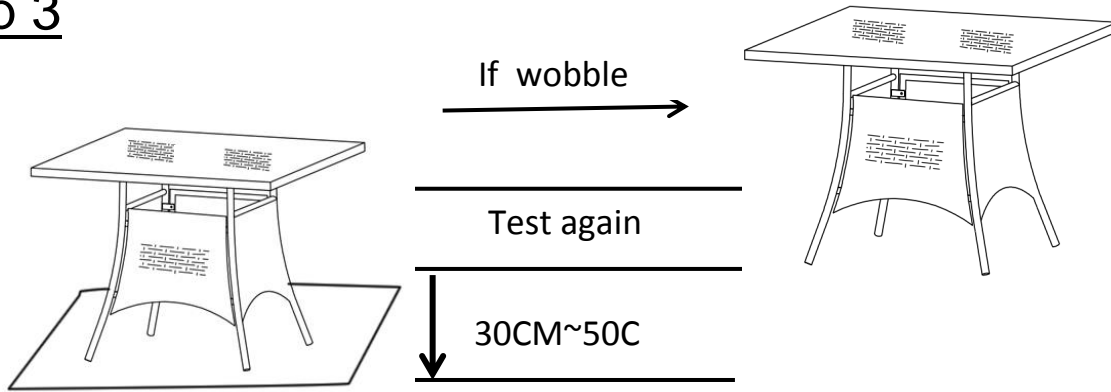

Place the table on a **LEVEL SURFACE** to check for wobbles.

If it wobbles, with 2 to 3 adult partners, lift the table to some 20cm to 30cm height from the ground.

Keep your feet and toes well away from the drop zone.

Drop the table freely and vertically with the four legs, hitting the ground, all at the same time. This Drop Test will help to ensure that all the bolts and gaps to all reach full alignment status. Test again for evenness on a **LEVEL SURFACE**.

If no wobbles found, with assistance from 2 to 3 adult partners, slowly and steadily, turn the table upside down.

Then, proceed to tighten all bolts in a sequential manner.

**CAUTION : When tightening these bolts, tighten sequentially.**

**DO NOT** tighten any screw fully and then towards the next one.

**This would cause the frame to warp.**

**If there is still wobbles, loosen the bolts and execute this same drop tests.**





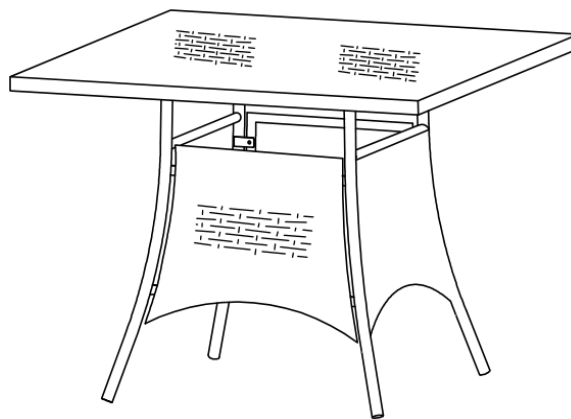















**WARNING!! IF TABLE IS NOT STABLE , IT COULD LEAD TO DAMAGING THE PRODUCT.**

## Step 4



Your table is ready for use.

## Care & Maintenance

-   ● Do not put hot items directly on furniture surface
  -   ● Do not clean furniture with harsh cleansers or polish.
  -   ● To obtain the longest lifespan of your outdoor products, minimizing exposure to direct sunlight is recommended.
  -   ● Children should not climb or jump on the furniture.
  -   ● Do not write on furniture without a padded barrier to protect the surface.
  -   ● To obtain the longest lifespan of your outdoor products, avoid extended and lengthy exposure to rain, snow, and direct sunshine. Whenever possible cover the product and /or place under patio or awnings.
  -   ● Not for commercial use. For residential use only .
  -   ● Stains may be removed with mild soap solution and damp cloth.
  -   ● Keep away from sources of ignition.
- 
-   ● Dust and pick-up spills using a clean, non-colored, lint-free cloth.

### Questions & Answers about Proposition 65

#### • What is Proposition 65?

Proposition 65 requires businesses to provide warnings to Californians about significant exposures to chemicals that cause cancer, birth defects or other reproductive harm. These chemicals can be in the products that Californians purchase, in their homes or workplaces, or that are released into the environment. By requiring that this information be provided, Proposition 65 enables Californians to make informed decisions about their exposures to these chemicals.

Proposition 65 also prohibits California businesses from knowingly discharging significant amounts of listed chemicals into sources of drinking water.

Proposition 65 requires California to publish a list of chemicals known to cause cancer, birth defects or other reproductive harm. This list, which must be updated at least once a year, has grown to include approximately 900 chemicals since it was first published in 1987.

#### • What types of chemicals are on the Proposition 65 list?

The list contains a wide range of naturally occurring and synthetic chemicals that include additives or ingredients in pesticides, common household products, food, drugs, dyes, or solvents. Listed chemicals may also be used in manufacturing and construction, or they may be byproducts of chemical processes, such as motor vehicle exhaust.

#### • What does a warning mean?

If a warning is placed on a product label or posted or distributed at a workplace, a business, or in rental housing, the business issuing the warning is aware or believes that it is exposing individuals to one or more listed chemicals.

By law, a warning must be given for listed chemicals unless the exposure is low enough to pose no significant risk of cancer or is significantly below levels observed to cause birth defects or other reproductive harm.

#### • Where can I get more information on Proposition 65?

If you have specific questions on the administration or implementation of Proposition 65, you can contact OEHHA's Proposition 65 program at [P65.Questions@oehha.ca.gov](mailto:P65.Questions@oehha.ca.gov), or by phone at (916) 445-6900.