

# Assembling Instruction

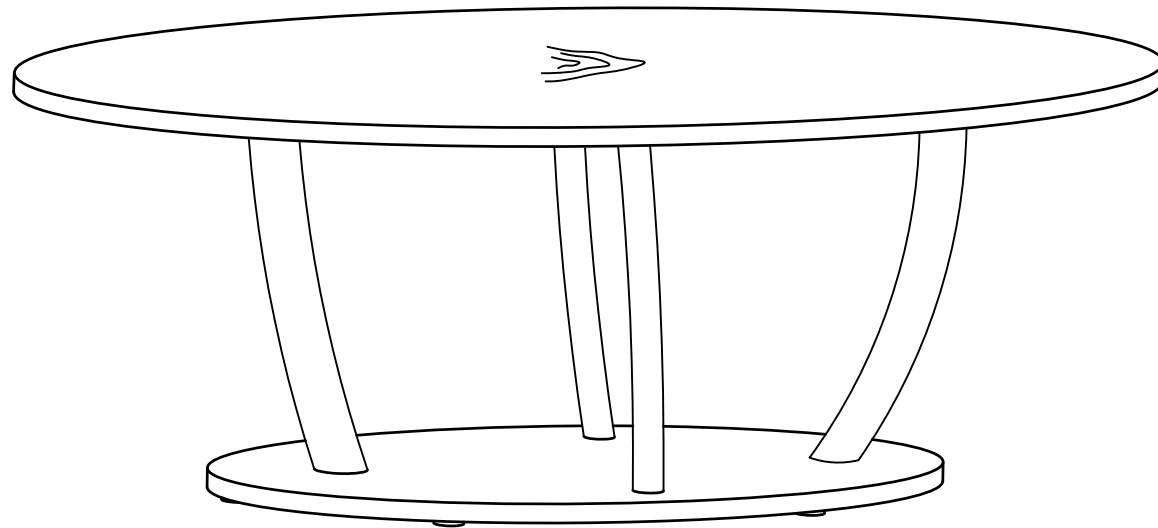

## PRODUCT DIMENSIONS

1000\*550\*420

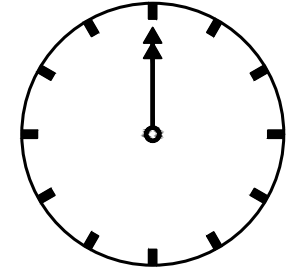

15 MIN

APPROXIMATE ASSEMBLY TIME



Single-Person Assembly

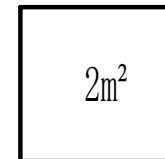

2m<sup>2</sup>

FLOOR AREA 1M\*2M

REQUIRED ASSEMBLY SPACE

# General Guidelines – Important Notice

## ● General Guidelines – Important Notice

Before starting assembly, be sure to read these instructions in full.

Please keep this manual and hand it over when transferring the product. This summary may not cover all variants or every detail of the steps to be considered. If you have any questions during installation, please contact us and we will provide assistance within 24 hours.

## ● Precautions

This product is for indoor use only. Assembly and use must be carried out in accordance with the instructions.

To avoid damaging your product, ensure that your electric drill is set to a low-torque mode.

Do not expose the product to humid environments for extended periods to prevent mold growth. During assembly, first align all screws with their corresponding pre-drilled holes, then tighten them one by one.

Check the screws regularly; they may loosen after long-term use. Retighten them if necessary to ensure stability and safety.

The seller shall not be liable for any damage or injury caused by improper assembly or use.

## ● Warnings

Children must not assemble this product. During assembly, keep children and pets away from the work area. Keep all small parts out of children's reach to prevent fatal risks from swallowing or inhalation. Children must not stand on, climb on, or play on the product to avoid serious bodily injury from product tipping. Keep plastic packaging bags out of children's reach to prevent potential suffocation hazards. Avoid contact between sharp objects, corrosive chemicals and the product to prevent product damage or bodily injury.

## ● Tip-over Warning!

Tipping furniture can cause serious or fatal crushing injuries. To prevent tipping, be sure to use the included wall anchoring device (if the product is not equipped with one). Purchase a wall anchoring device that matches your wall size. If in doubt, seek professional advice. Read and follow each step in the instructions carefully.

Do not allow children to climb on the furniture or hang items on it

Do not open multiple drawers at once

Do not place heavy objects in the top drawer

Do not place heavy objects on top of the furniture

Note that only the anti-tip nails are provided.

You will also need to prepare wall plugs and screws suitable for your wall type.

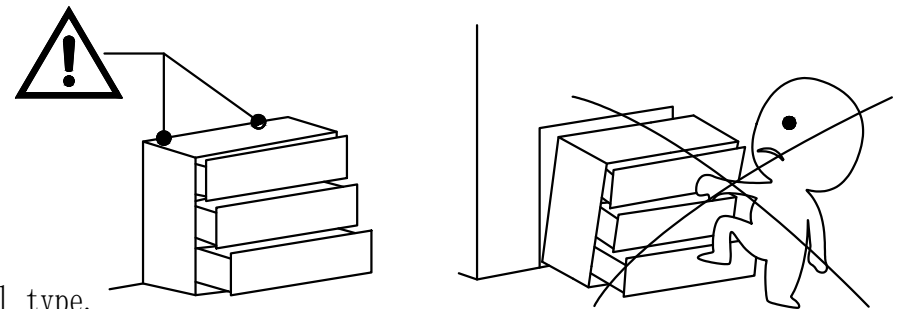

## ● Maintenance and Care

Clean the device only with a damp cloth. Inspect it regularly and use mild detergent; do not use bleach or abrasive cleaners to avoid damaging the device.

This device should not be disposed of with household waste and must be taken to a local government waste disposal center.

# Main parts list

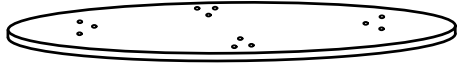

① ×1

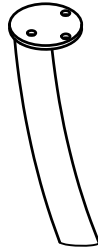

② ×2



③ ×2

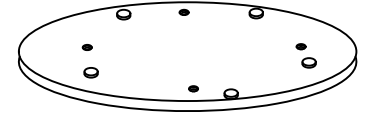

④ ×1

# Accessories List

Ⓐ

×12

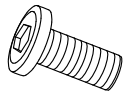

M6\*12

Ⓑ

×4

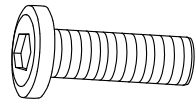

M8\*25

Ⓒ

×1



S=4

Ⓓ

×1



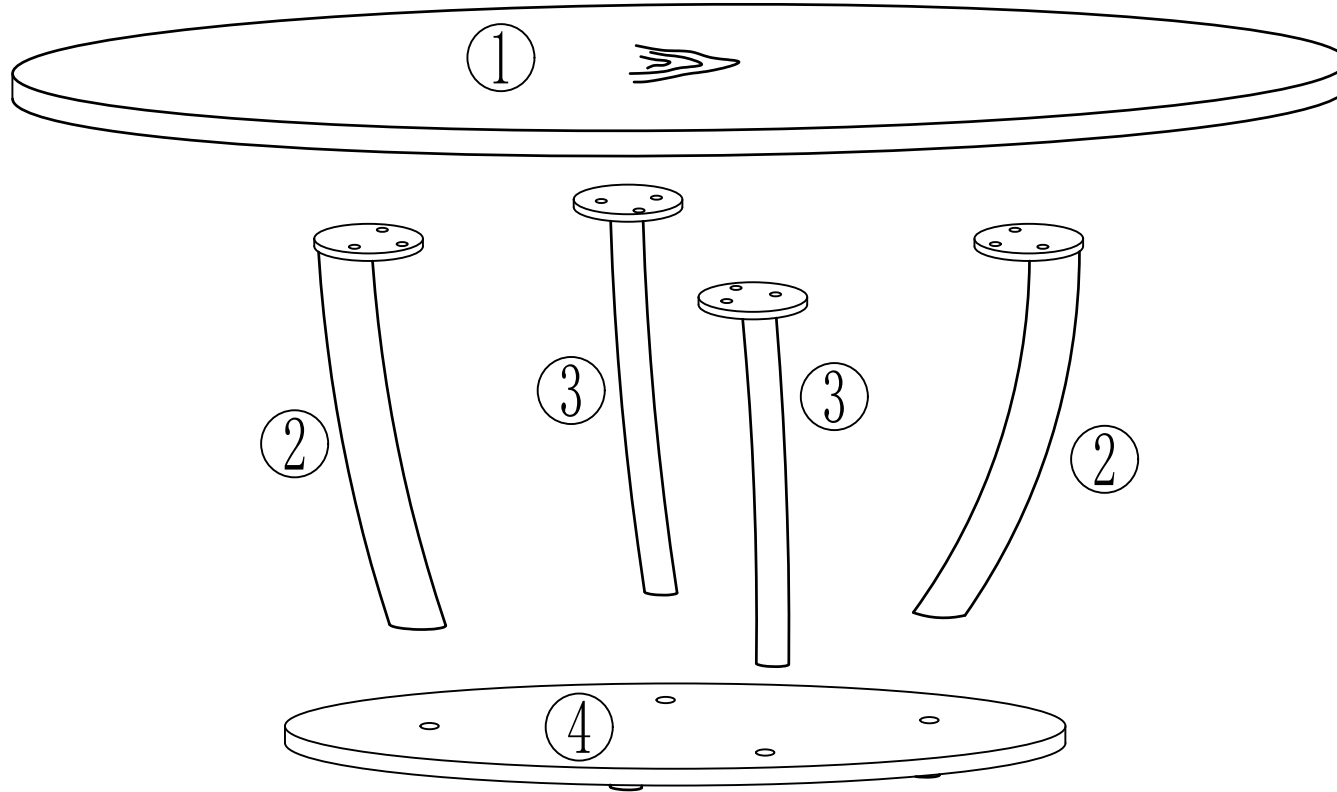

S=5

# Assembling Instruction



# Assembling Instruction

(A)	×12	(C)	×1
			
M6*12		S-4	

Step 1

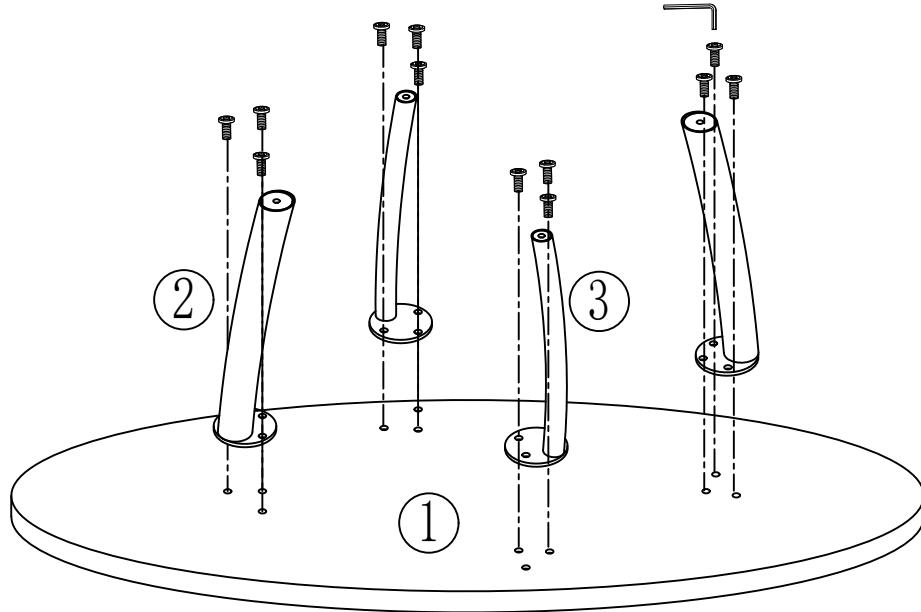
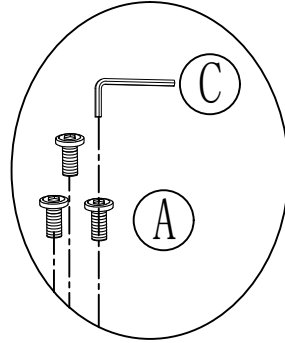

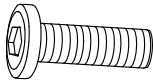
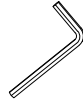
(B)	×4	(D)	×1
			
M8*25		S-5	

Step 2

