

# Assembly Instructions

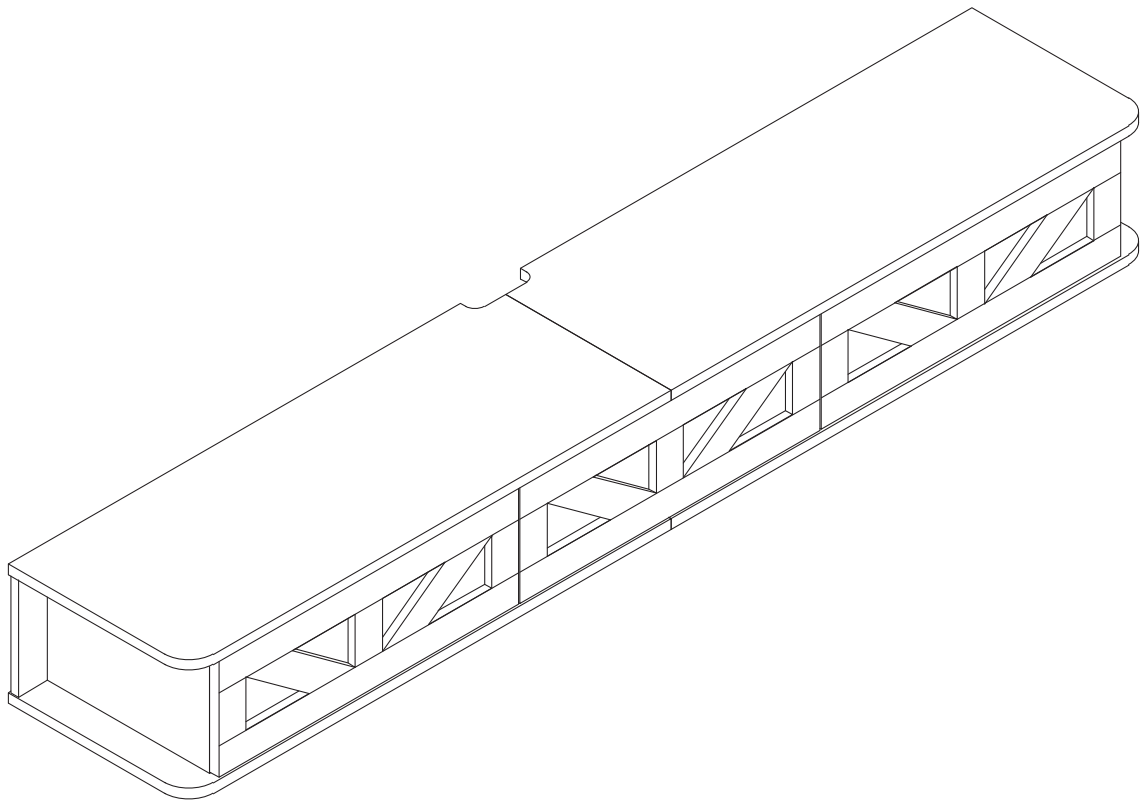

## CUSTOMER CARE



**Congratulations  
Happy shopping**  
Feel free to share with your friends or family  
Thank you for your 5-star feedback and positive  
reviews to help others  
Good advice leads to the best service

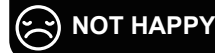

**We apologize for the bad shopping experience  
Any defects, broken, missing pieces, delays or  
accidents Please contact us as soon as possible  
online email or official email are available.**

## ITEM SPECIFICATION

SKU	Product Dimension	Package Dimension	Color
A	62.99*11.81*7.87 in	36.42*22.83*4.92 in	White
B	62.99*11.81*7.87 in	36.42*22.83*4.92 in	Black

## NOTICE:

Basic precautions should always be followed when using this product. Please read all instructions before using the cabinet and retain the education for future reference.

Failure to observe all instructions and warnings may cause severe property damage or personal injuries.

When unpacking, please be careful don't cut too deep to damage the products in the box. Just use the blade to scratch the parcel tape.

Check the product and hardware accessories in the box; and confirm whether the instructions are complete.

When installing, please pay attention to the protection of the parts. The soft material must be placed under the product, and please carefully handle it to avoid surface damage.

After the assembly is completed, please adjust the placement position according to the actual situation.

Keep children away from cabinets, accessories, and installation tools. They are at risk of injury to the child.

Two people are recommended for assembly.

If you need the electronic manual, please contact our customer service to get it.

## RETURN/DAMAGE CLAIM INSTRUCTIONS:

The product is shipped in a single carton box. If you haven't received the package or need to know the tracking of the package, get in touch with us immediately via Amazon message or contact us.

If the package is damaged, please get in touch with us from the very beginning. Attaching a damaged photo is appreciated.

The product accepts returns within 30 days without any reason. If you return this item for personal reasons, you must cover the return fee and order processing fee (0- 20% restocking fee based on the invoice price). We will cover the freight if the product has quality issues (not caused by humans).

Please keep the original box if you need to return the goods. Please use our return label and do not return it without permission.

If you return the product after 30 days of receiving it, we are afraid your return application won't be accepted. We appreciate your understanding.

Any damages, defects and parts missings during installation, pls contact us from the very beginning. Replacement, exchange and refund will be arranged ASAP except of personal reasons.

## Part List



Open the package, and put the item on the mat with care. Please install it carefully to ensure your fingers will not be scratched.

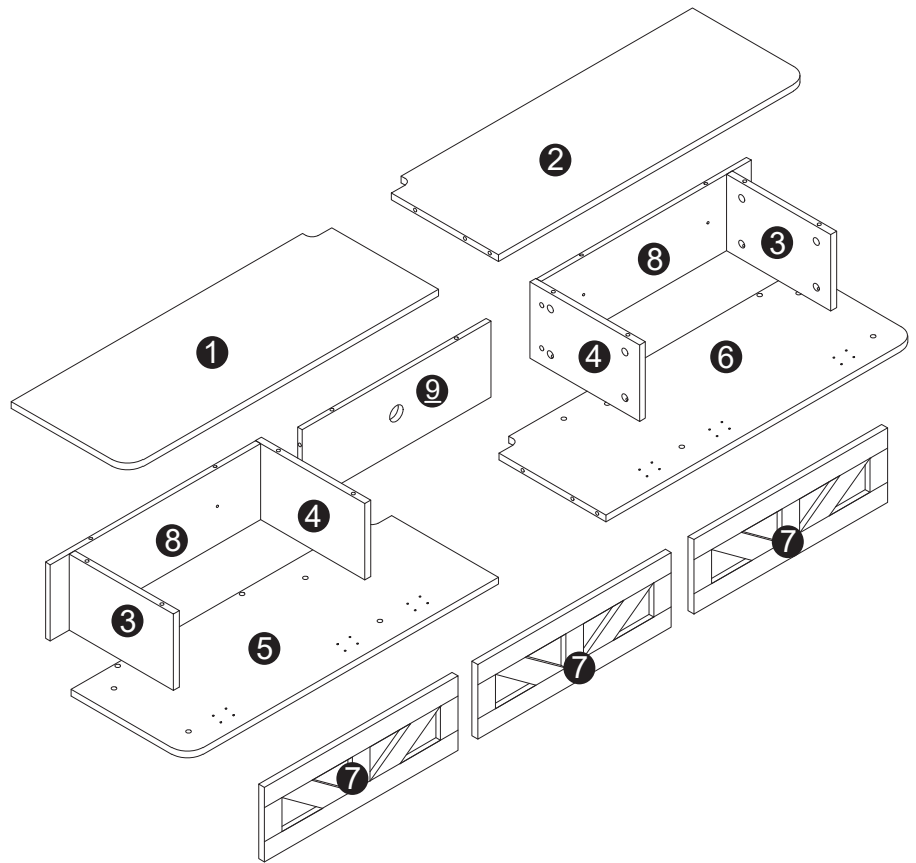
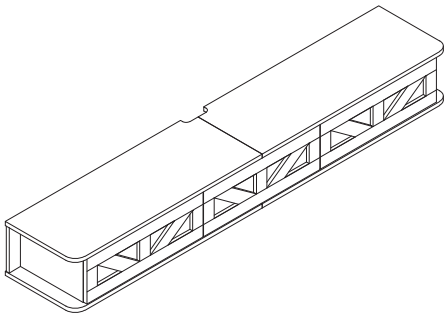

## Hardware List

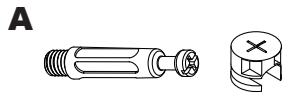

**A**  
 $\phi 15 \times 12 \text{mm}$   
 $M6 \times 40 \text{mm}$   
 x32 (+1)

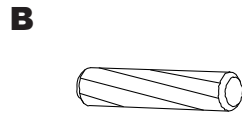

**B**  
 $M8 \times 30 \text{mm}$   
 x2 (+1)

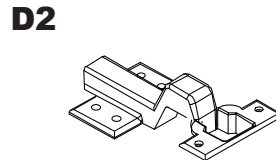

**D2**  
 x6

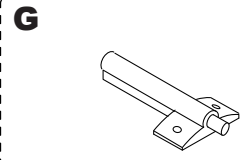

**G**  
 x3



**M**  
 $M3.5 \times 14 \text{mm}$   
 x42 (+1)



**R**  
 $M6 \times 60 \text{mm}$   
 $\phi 10 \times 11 \text{mm}$   
 $\phi 15 \times 12 \text{mm}$   
 x4 (+1)

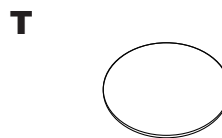

**T**  
 x32 (+1)

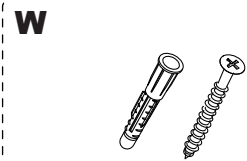

**W**  
 x4 (+1)

Extra white cam



x2

# Start...

## Step 1

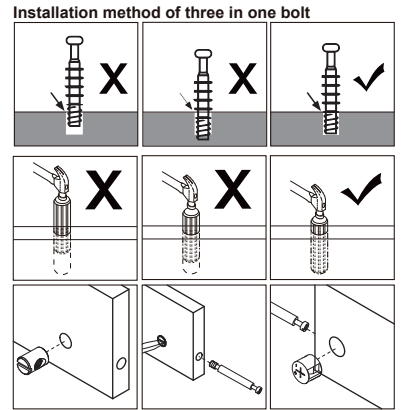
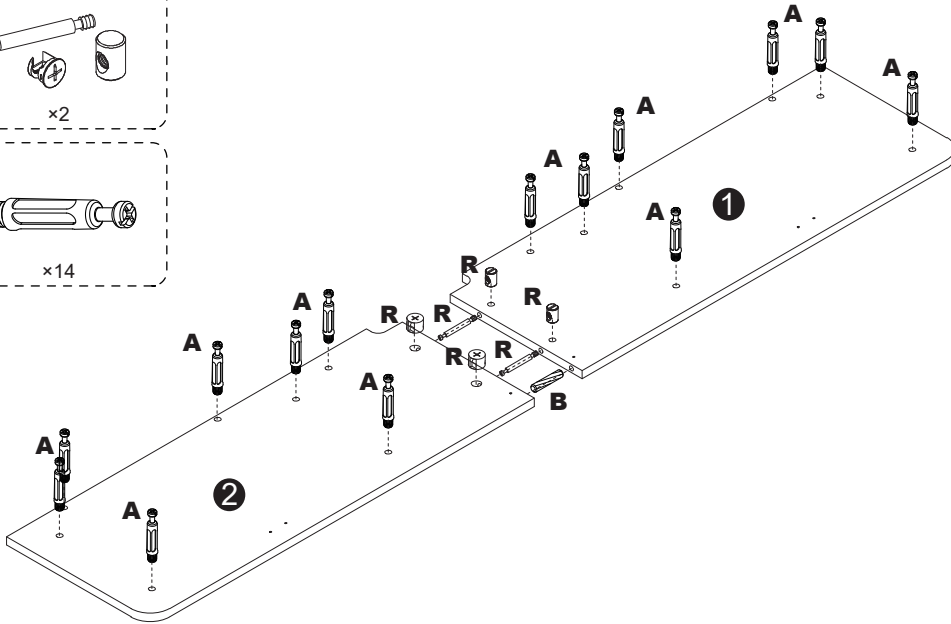
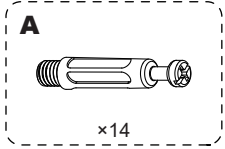
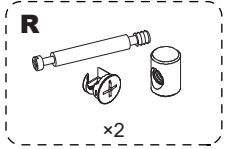
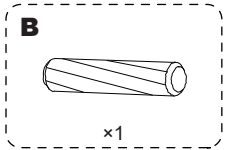

## Step 2

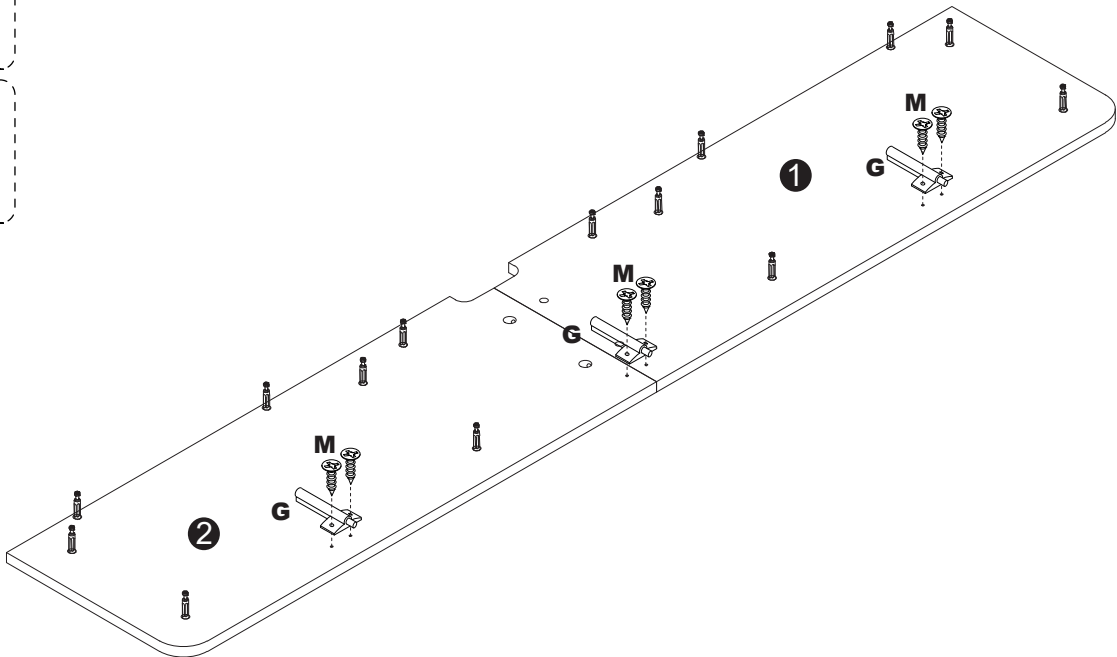
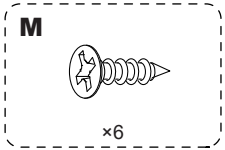
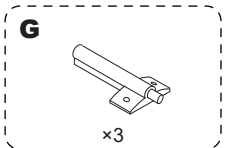

### Step 3

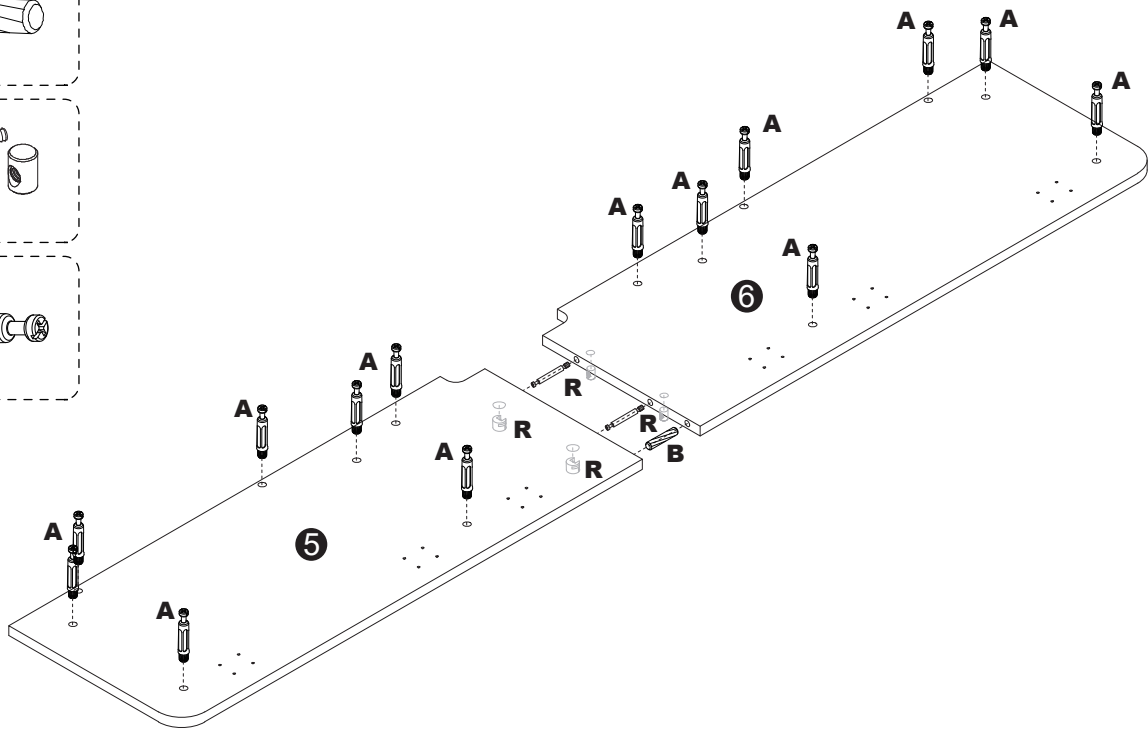
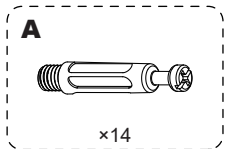
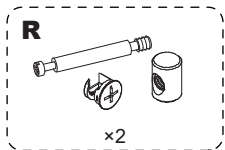
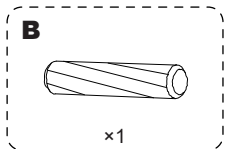

### Step 4

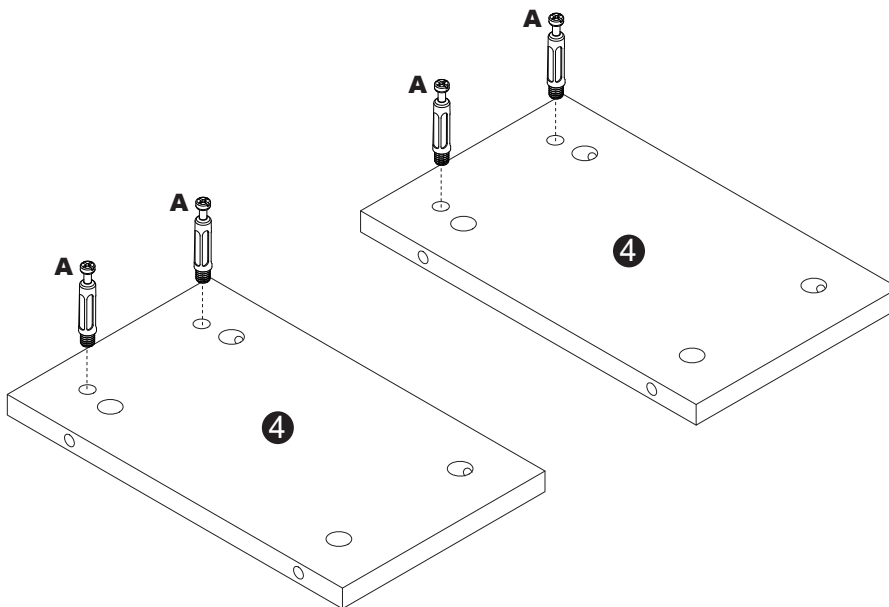
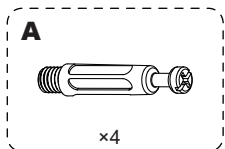

## Step 5

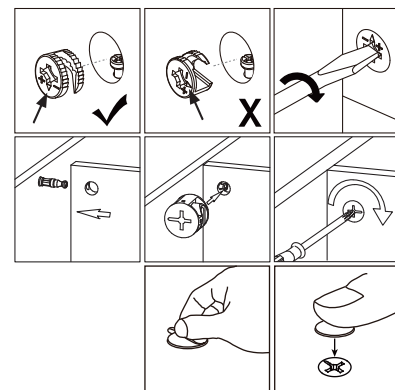
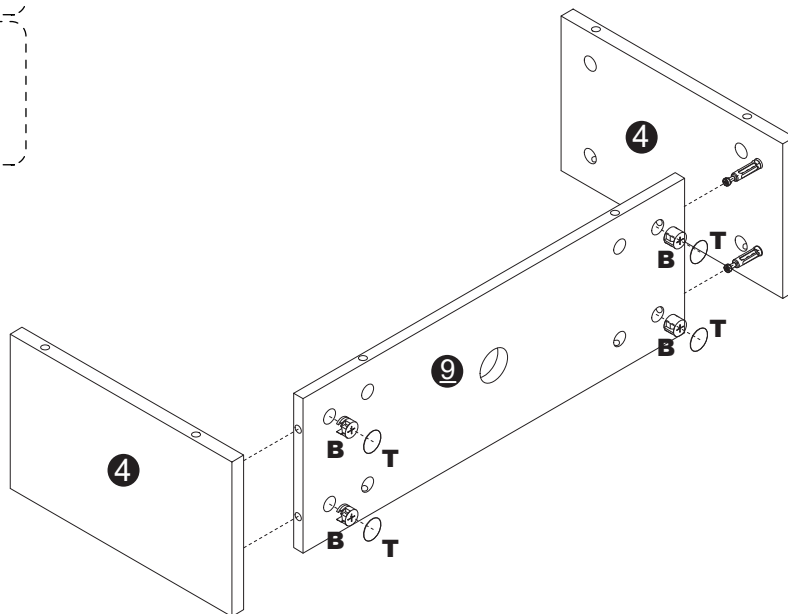
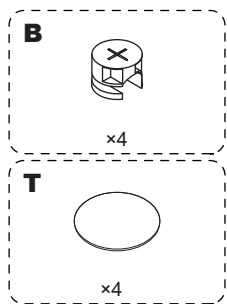

## Step 6

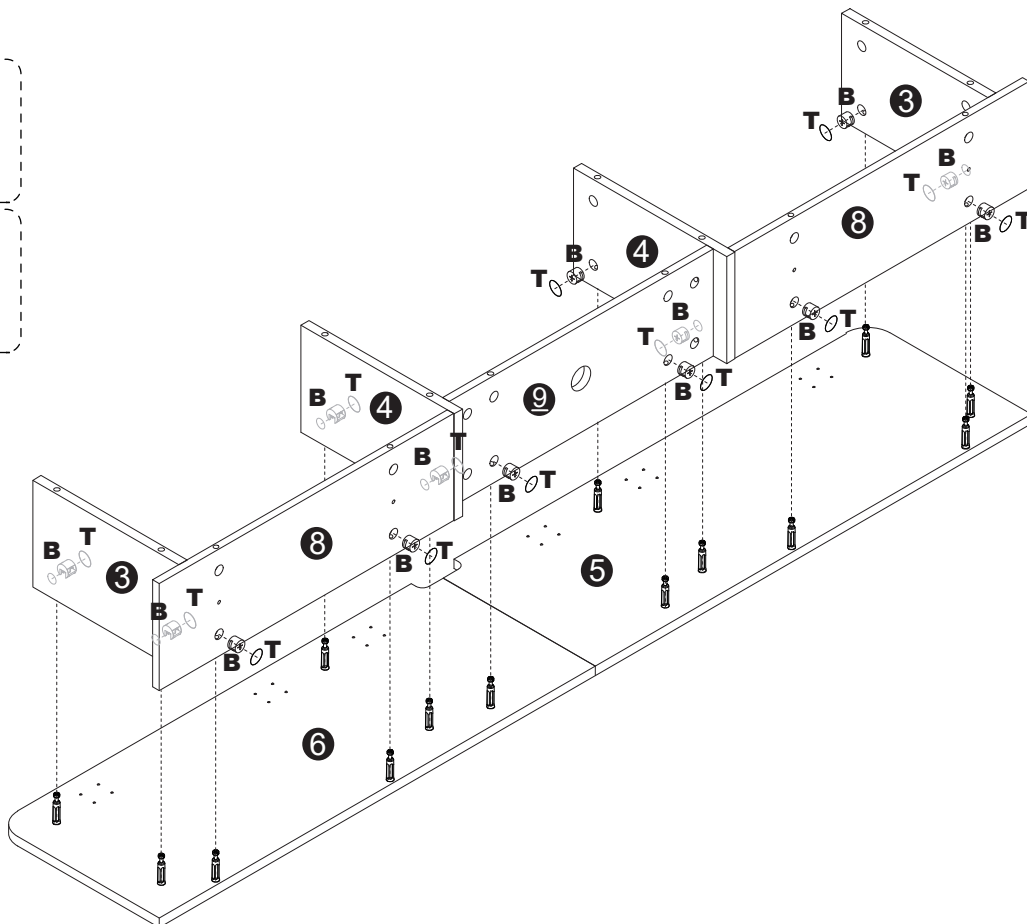
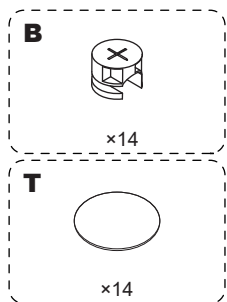

## Step 7

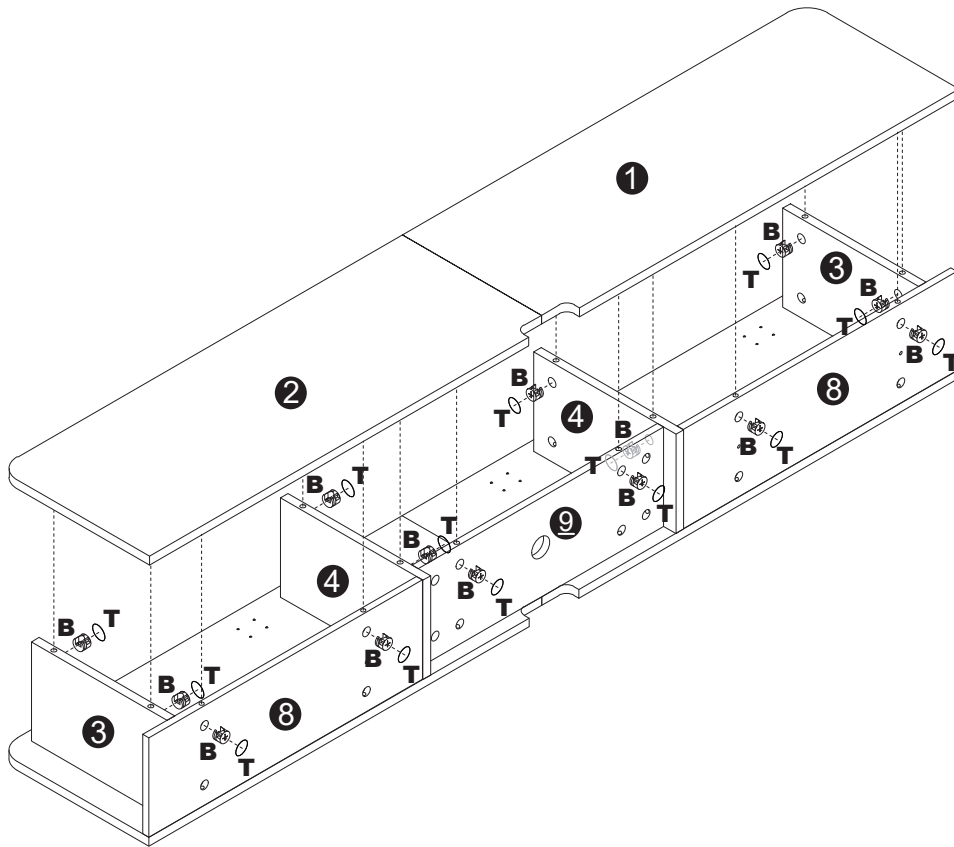
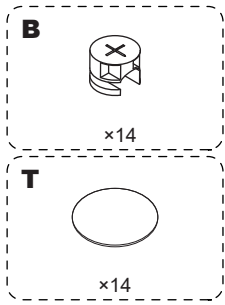

## Step 8

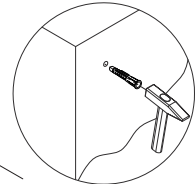
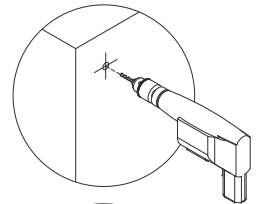
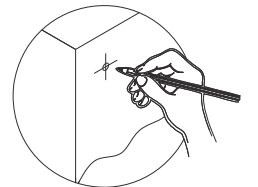
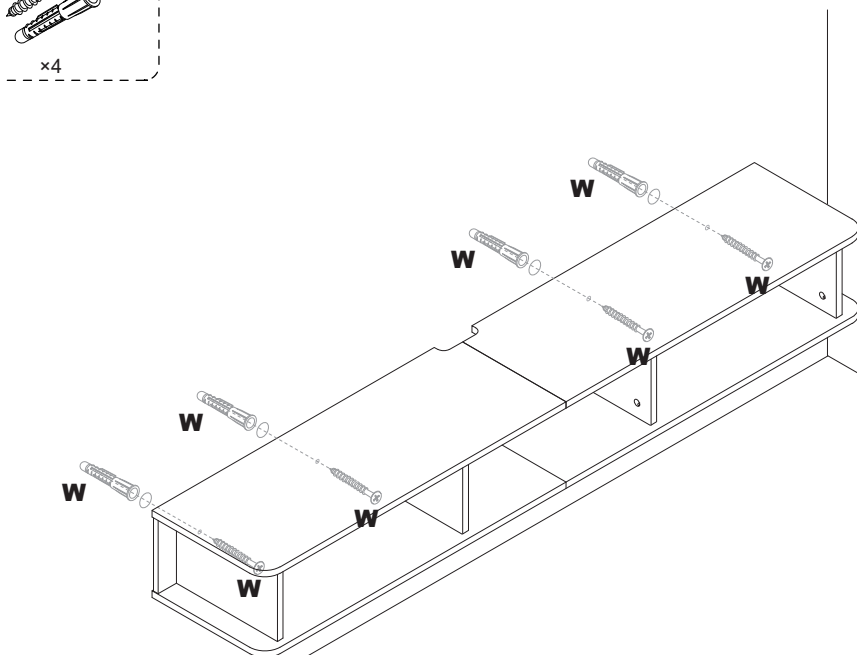
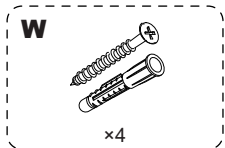



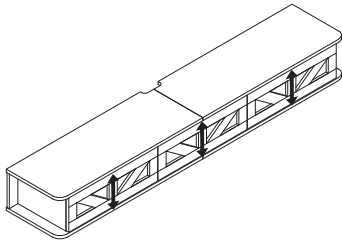

### Hinge adjustment

**A:** To move doors up or down:  
Loosen screws shown and move doors to suit.  
Once doors are aligned, re-tighten screws.

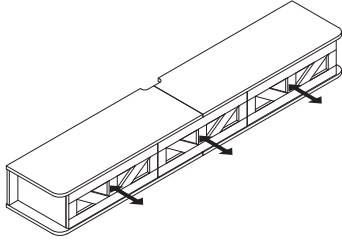
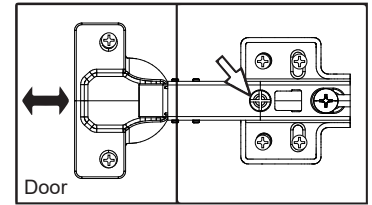

### Hinge adjustment

**B:** To move doors in or out:  
Loosen screw shown and move doors to suit.  
Re-tighten screws.

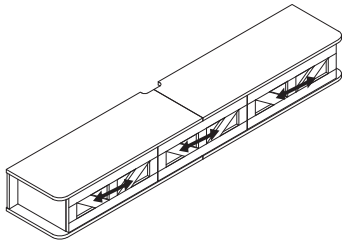
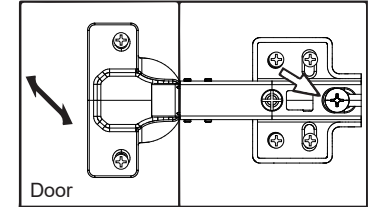

### Hinge adjustment

**C:** To move doors left or right:  
Loosen screw shown and move doors to suit.  
Re-tighten screws.

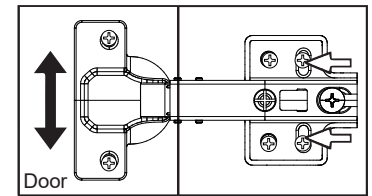

## About Us

We break the traditional monotonous furniture style and give it new meaning through LED lights, which are both functional and beautiful. Our professional team provides you with innovative and customized design and attentive service, aiming to meet our customer's specific needs around the world, bringing you high quality furniture and colorful and meaningful life. Since now, we have expanded into the production of a wide variety of LED lighted furniture from living room, bedroom to bathroom.