

# Assembly Instructions

Caution : You must read this before you proceed

## Umbrella Base

Reminder : Maximum diameter for open Umbrella - 80 inches

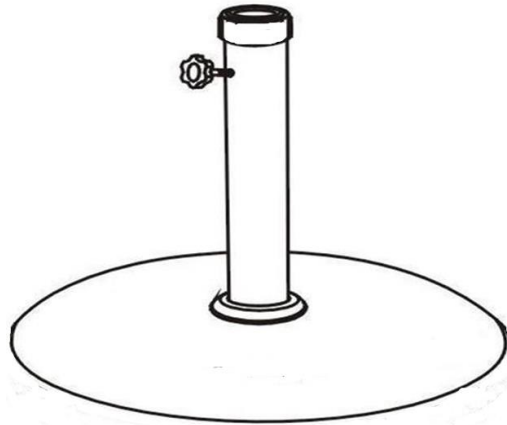

### Parts List

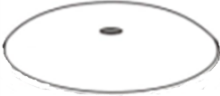
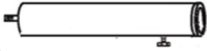
Label	Picture	Description	QTY
A		Umbrella Base	1
B		Support Pole	1

### Hardware

①		Nut	1
②		Washer	1
③		38mm & 48mm Adapter	1
④		Gasket	1
⑤		Socket Wrench	1

# Assembly Preparation

**Before Beginning Assembly:**

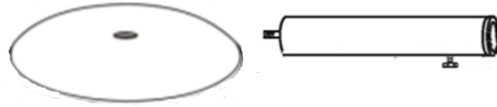

- Read instructions, cover to cover-



- Have 2 adults on hand for assembly-



- Do not assemble on flooring or carpet-



- Assemble on a clean non-marring surface (packing foam)-



- Save all packaging until finished-

**WARNING: CHOKING HAZARD.** Do not allow children to play with plastic wraps or any small parts in this package.  
**Notice:** As a safety precaution, when your Umbrella is not in use, please close the Umbrella.  
Remove Umbrella from this Base and store in safe location

**ATTENTION:** This Umbrella Base is exclusively recommended to be used together under a table with the matching Umbrella with diameter of 71 inches to 80 inches.  
The matching Support Pole diameter: 38mm - 48mm.

# Assembly Steps

## Overview

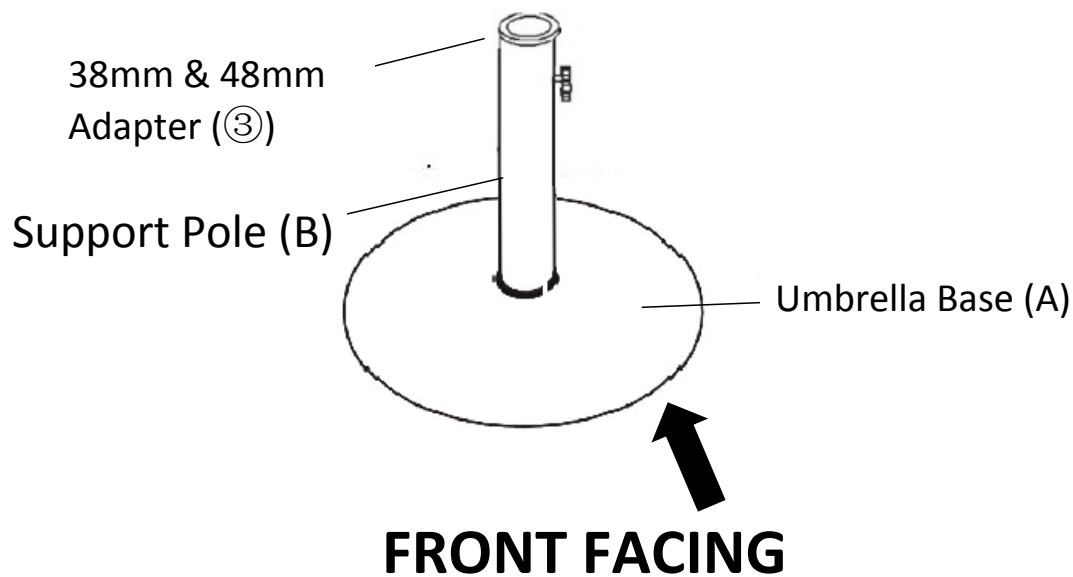

This Umbrella Base has multiple parts and may require up to 30 minutes to assemble. To give you an overview of the Umbrella parts, the above picture is to help you put the various parts into perspective. Please read through the instructions below to familiarise yourself with the parts and steps before assembly.

## Step 1

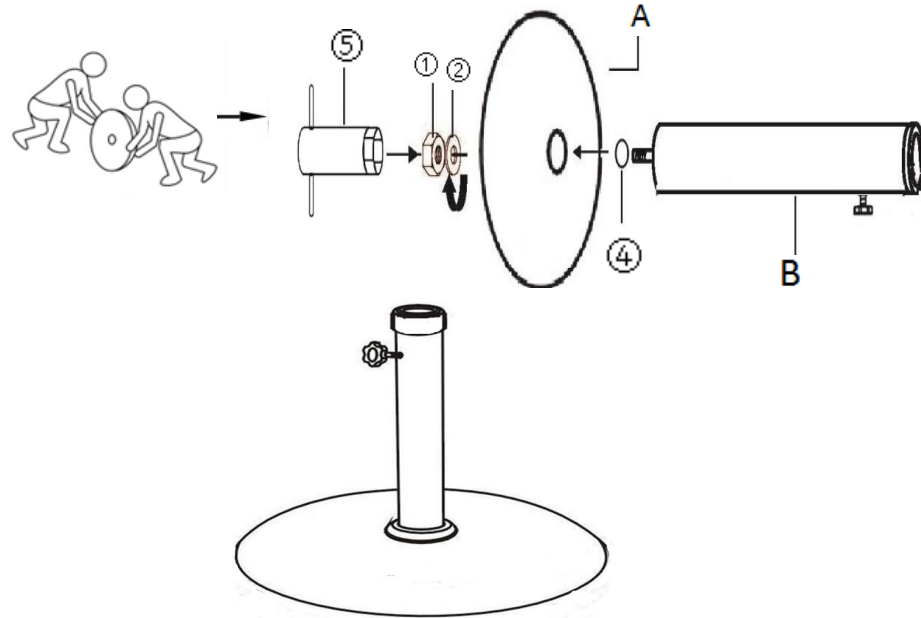

**This is a two person team assembly product.**

Tilt the Umbrella Base to its side as pictured.

Attach Support Pole(B) and Gasket(4) to Umbrella Base(A) using Washer(2) and Nut(1) with Socket Wrench(5).

**Tighten Bolt until fully secure.**

## Operation Instruction

### **For Umbrella Pole with 48mm diameter:**

Insert the 38mm & 48mm Adapter(3) into the Support Pole(B). Pull out the 38mm Adapter; Then insert your 48mm Umbrella Pole. Tighten the Adjustable Screw on the Support Pole to secure your Umbrella Pole.

The Umbrella Base is ready for use.

**This Umbrella Base only be used on a flat, level surface.**

### **For Umbrella Pole with 38mm diameter:**

















Insert the 38mm & 48mm Adapter(3) into the Support Pole(B).

Then insert your 38mm Umbrella Pole. Tighten the Adjustable Screw on the Support Pole to secure your Umbrella Pole.

The Umbrella Base is ready for use.

**This Umbrella Base only be used on a flat, level surface.**

## Care & Maintenance

-   • Do not put hot items directly on furniture surface
  -   • Do not clean furniture with harsh cleansers or polish.
  -   • To obtain the longest lifespan of your outdoor products, minimizing exposure to direct sunlight is recommended.
  -   • Children should not climb or jump on the furniture.
  -   • To obtain the longest lifespan of your outdoor products, avoid extended and lengthy exposure to rain, snow, and direct sunshine. Whenever possible cover the product and /or place under patio or awnings.
  -   • Not for commercial use. For residential use only .
  -   • Stains may be removed with mild soap solution and damp cloth.
- 
-   • Dust and pick-up spills using a clean, non-colored, lint-free cloth .

### Questions & Answers about Proposition 65

#### • What is Proposition 65?

Proposition 65 requires businesses to provide warnings to Californians about significant exposures to chemicals that cause cancer, birth defects or other reproductive harm. These chemicals can be in the products that Californians purchase, in their homes or workplaces, or that are released into the environment. By requiring that this information be provided, Proposition 65 enables Californians to make informed decisions about their exposures to these chemicals.

Proposition 65 also prohibits California businesses from knowingly discharging significant amounts of listed chemicals into sources of drinking water.

Proposition 65 requires California to publish a list of chemicals known to cause cancer, birth defects or other reproductive harm. This list, which must be updated at least once a year, has grown to include approximately 900 chemicals since it was first published in 1987.

#### • What types of chemicals are on the Proposition 65 list?

The list contains a wide range of naturally occurring and synthetic chemicals that include additives or ingredients in pesticides, common household products, food, drugs, dyes, or solvents. Listed chemicals may also be used in manufacturing and construction, or they may be byproducts of chemical processes, such as motor vehicle exhaust.

#### • What does a warning mean?

If a warning is placed on a product label or posted or distributed at a workplace, a business, or in rental housing, the business issuing the warning is aware or believes that it is exposing individuals to one or more listed chemicals.

By law, a warning must be given for listed chemicals unless the exposure is low enough to pose no significant risk of cancer or is significantly below levels observed to cause birth defects or other reproductive harm.

#### • Where can I get more information on Proposition 65?

If you have specific questions on the administration or implementation of Proposition 65, you can contact OEHHA's Proposition 65 program at [P65.Questions@oehha.ca.gov](mailto:P65.Questions@oehha.ca.gov), or by phone at (916) 445-6900.