











Assembly Instructions

Caution: You must read this before you proceed

Care & Maintenance

	<ul style="list-style-type: none">● Not for commercial use. For residential use only.
	<ul style="list-style-type: none">● Do not put hot items directly on furniture surface.
	<ul style="list-style-type: none">● Do not clean furniture with harsh cleansers or polish.
	<ul style="list-style-type: none">● Do not place furniture under direct sunlight.
	<ul style="list-style-type: none">● Do not place furniture near heating or cooling vents.
	<ul style="list-style-type: none">● Do not write on furniture without a padded barrier to protect the surface.
	<ul style="list-style-type: none">● Do not place furniture outside . For indoor use only.
	<ul style="list-style-type: none">● Stains may be removed with mild soap solution and damp cloth.
	<ul style="list-style-type: none">● Children should not climb or jump on the furniture.
	<ul style="list-style-type: none">● Dust and pick-up spills using a clean, non-colored, lint-free cloth.

QUEEN BED

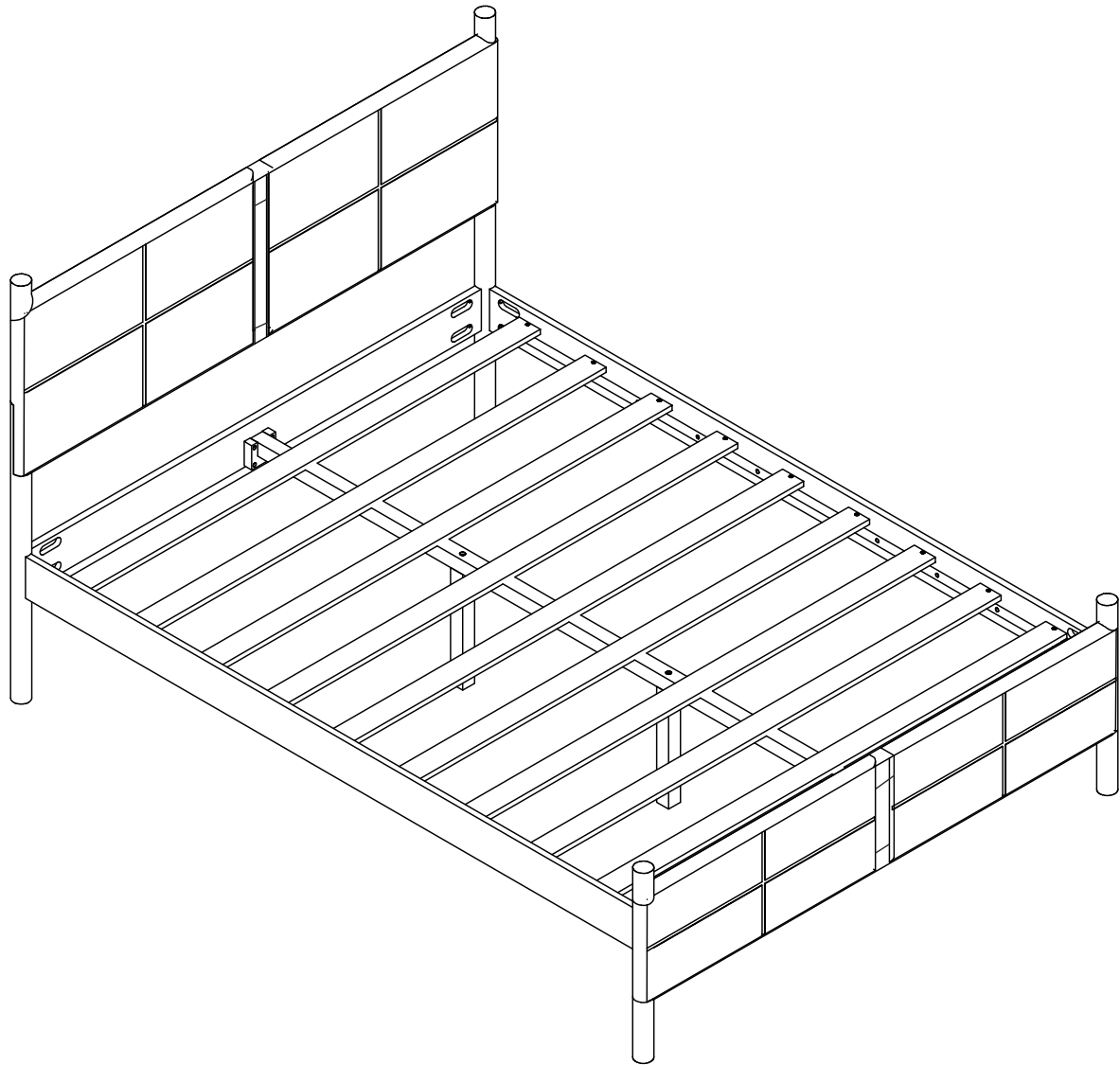
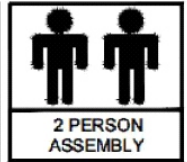
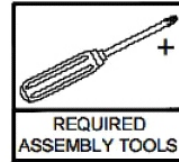

WARNING

STRANGULATION HAZARD.

NEVER place bed near windows where cords from blinds or drapes may strangle a child.
NEVER suspend strings over bed.
NEVER place items with a string, cord, or ribbon, such as hood strings or pacifier cords, around a child's neck. These items may catch on bed parts.
ALWAYS follow assembly instructions.



WARNING!

Not intended for children under the age of six. **INFANTS HAVE DIED FROM BECOMING ENTRAPPED IN BEDS.** Openings in and between bed parts can entrap the neck and head of a small child. NEVER use bed for child under the age of six.

The mattress must be appropriately sized for the bed. If the mattress is undersized, dangerous gaps can exist and a person can become entrapped or entangled in the frame and suffocate.

Note: This Bed is NOT a TOY.

Keep your child/children at bay during the assembly process.



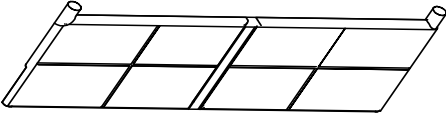
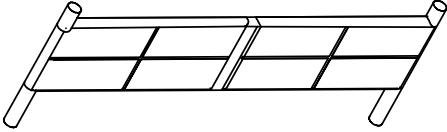

The BED is HEAVY.

To prevent injury to yourself or damage to the product a minimum of two adults are required whenever moving or lifting it.



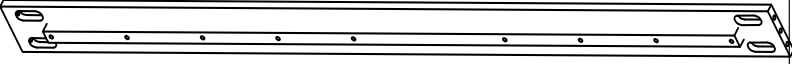
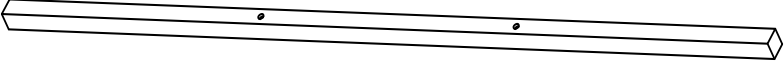
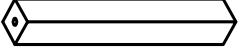
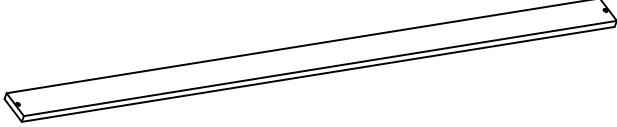

Part List BOX 1 OF 2 N758P249284N

Label	Picture	Description	Qty
A	 A perspective view of a rectangular headboard assembly. It consists of a central vertical support post and two side rails, with three horizontal slats connecting them.	Headboard	1
E	 A perspective view of a rectangular footboard assembly. It consists of a central vertical support post and two side rails, with three horizontal slats connecting them.	Footboard	1

Part List BOX 2 OF 2 N758P249285N

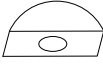
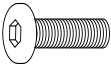
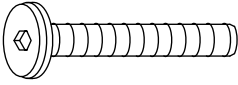
Label	Picture	Description	Qty
B	 A long, thin rectangular leg with a rounded end on the left and a small notch on the right.	Headboard Leg-L	1
C	 A long, thin rectangular leg with a rounded end on the left and a small notch on the right.	Headboard Leg-R	1
D	 A long, thin rectangular panel with a central notch and small tabs at the ends.	Cross Panel	1
F	 A long, thin rectangular panel with a beveled edge on the left side.	Side Panel - L	1
G	 A long, thin rectangular panel with a beveled edge on the right side and small tabs along the bottom edge.	Side Panel - R	1
J	 A long, thin rectangular support piece with a beveled edge and two small holes.	Slats Support	1
K	 A short, wide rectangular leg with a beveled edge and a small hole.	Center Leg	2
L	 A long, thin rectangular slat with a beveled edge.	Slat	9

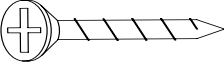
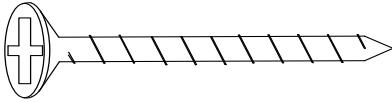
Hardware List- (Box 1/N758P249284N)

Label	Picture	Description	Qty
①		Wooden Dowel ∅ 10 x 30	10
②		Half moon Nut 12 x 20	12
③		Short Bolt 1/4" x 38	6
④		Long Bolt 1/4" x 60	14
⑤		Flat washer 1/4" x 13	6
⑥		Spring washer 1/4" x 13	6
⑦		Flat screw M4 x 25 extra =4pc	22
⑧		Flat screw M4 x 40	2
⑨		Allen Wrench K4 x 80 extra =1pc	2
⑩		Screwdriver (Not provided)	1

Assembly Preparation

Before Beginning Assembly:

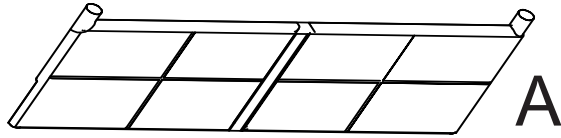

A

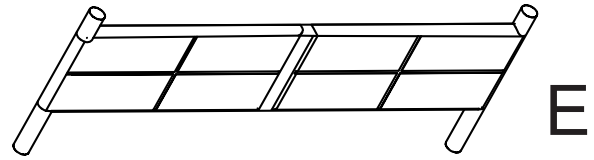

E

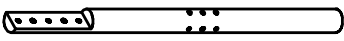

B

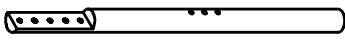

C



D

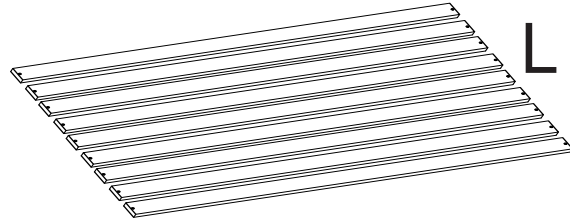

L

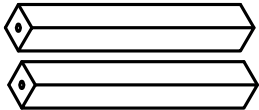

K

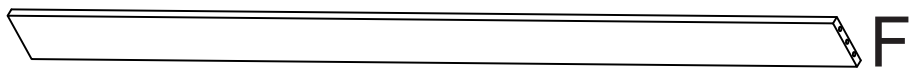

F

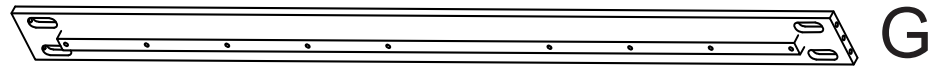

G



J

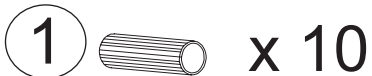

1 x 10

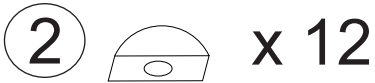

2 x 12

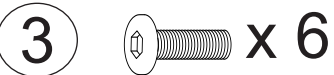

3 x 6

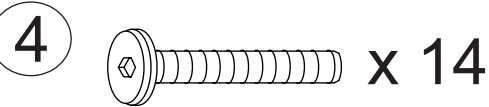

4 x 14

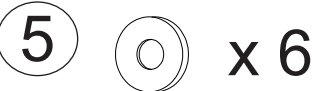

5 x 6



6 x 6

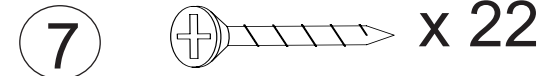

7 x 22

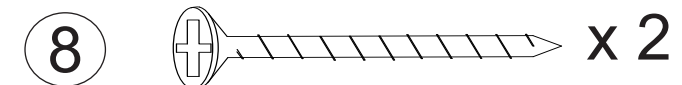

8 x 2



9 x 1



• Read instructions, cover to cover-



• Have 2 adults on hand for assembly-



• Do not assemble on flooring or carpet-



• Assemble on a clean non-marring surface (packing foam)-



• Save all packaging until finished-

Assembly Steps

Overview

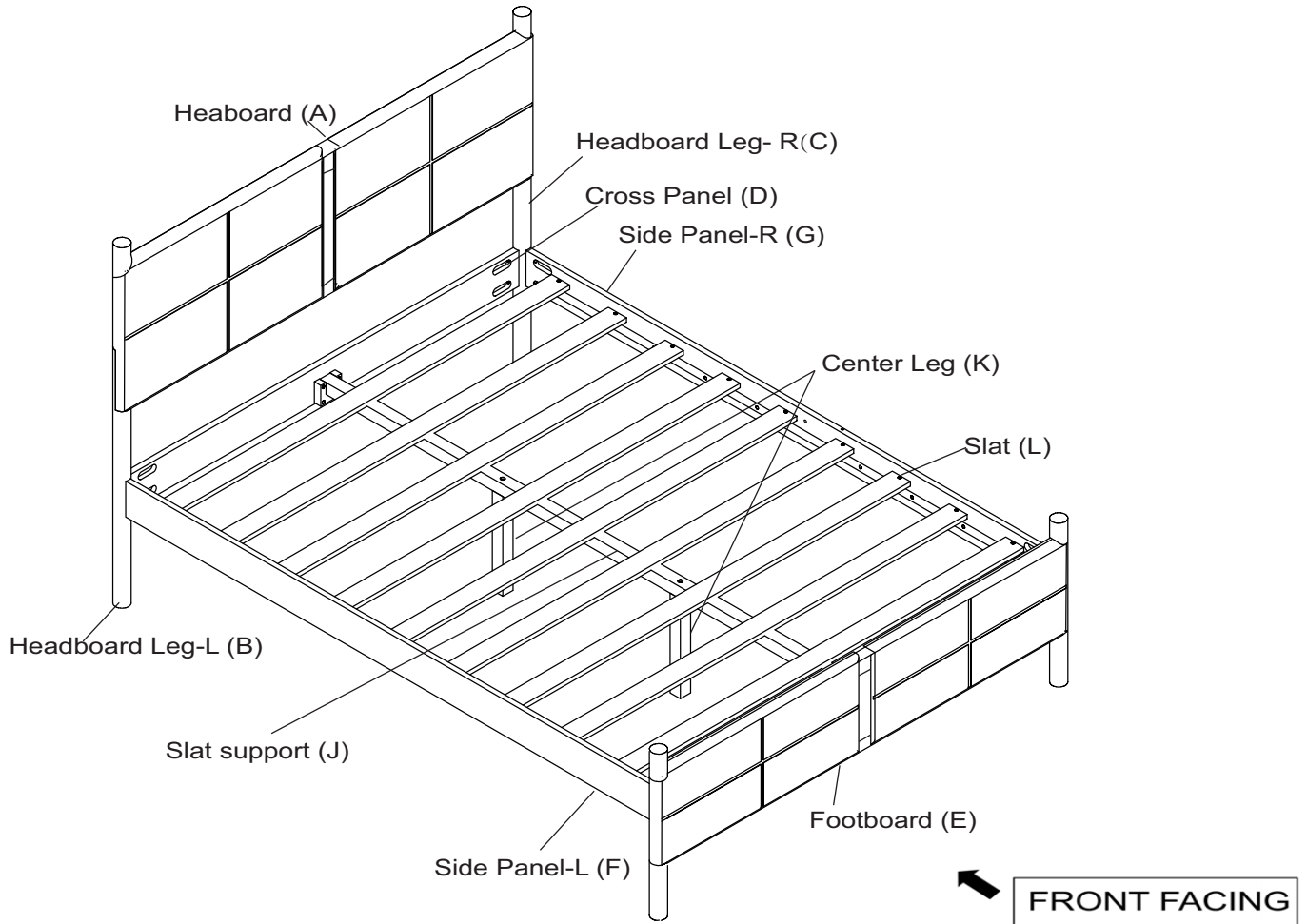

This Bed has multiple parts and may require up to 30 minutes to assemble. To give you an overview of the Bed parts, the above picture is provided to help you put the various parts into perspective. Please read through the instructions below to familiarise yourself with the parts and steps before assembly.

Step 1

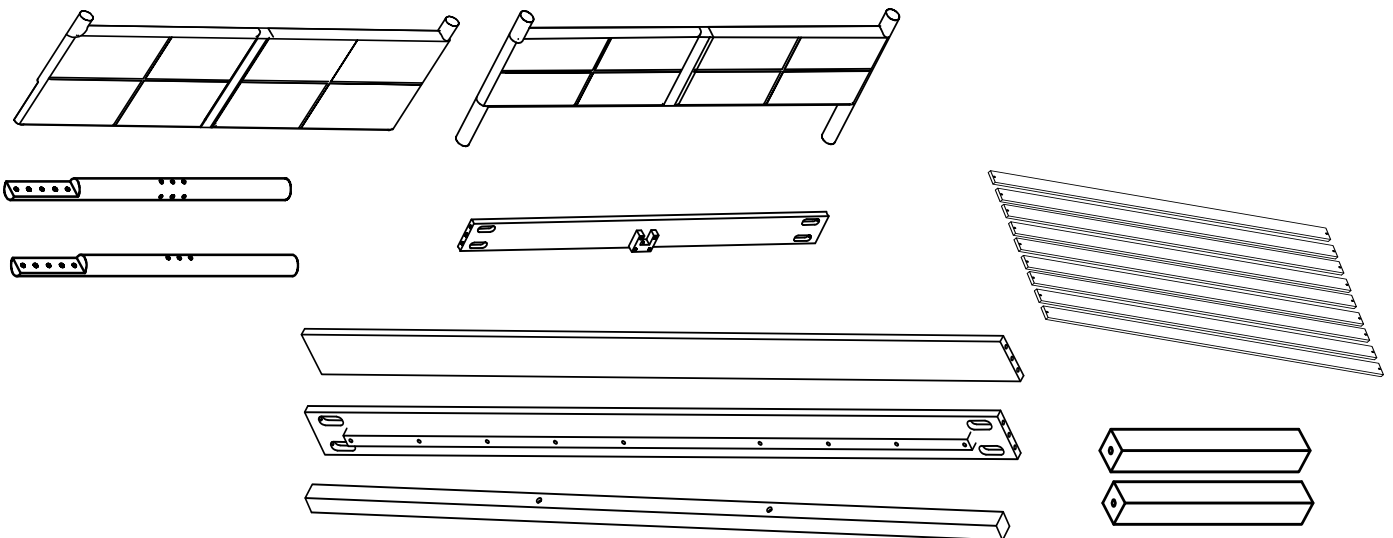

Unpack and place all parts on a clean, non-marring surface.

Step 2

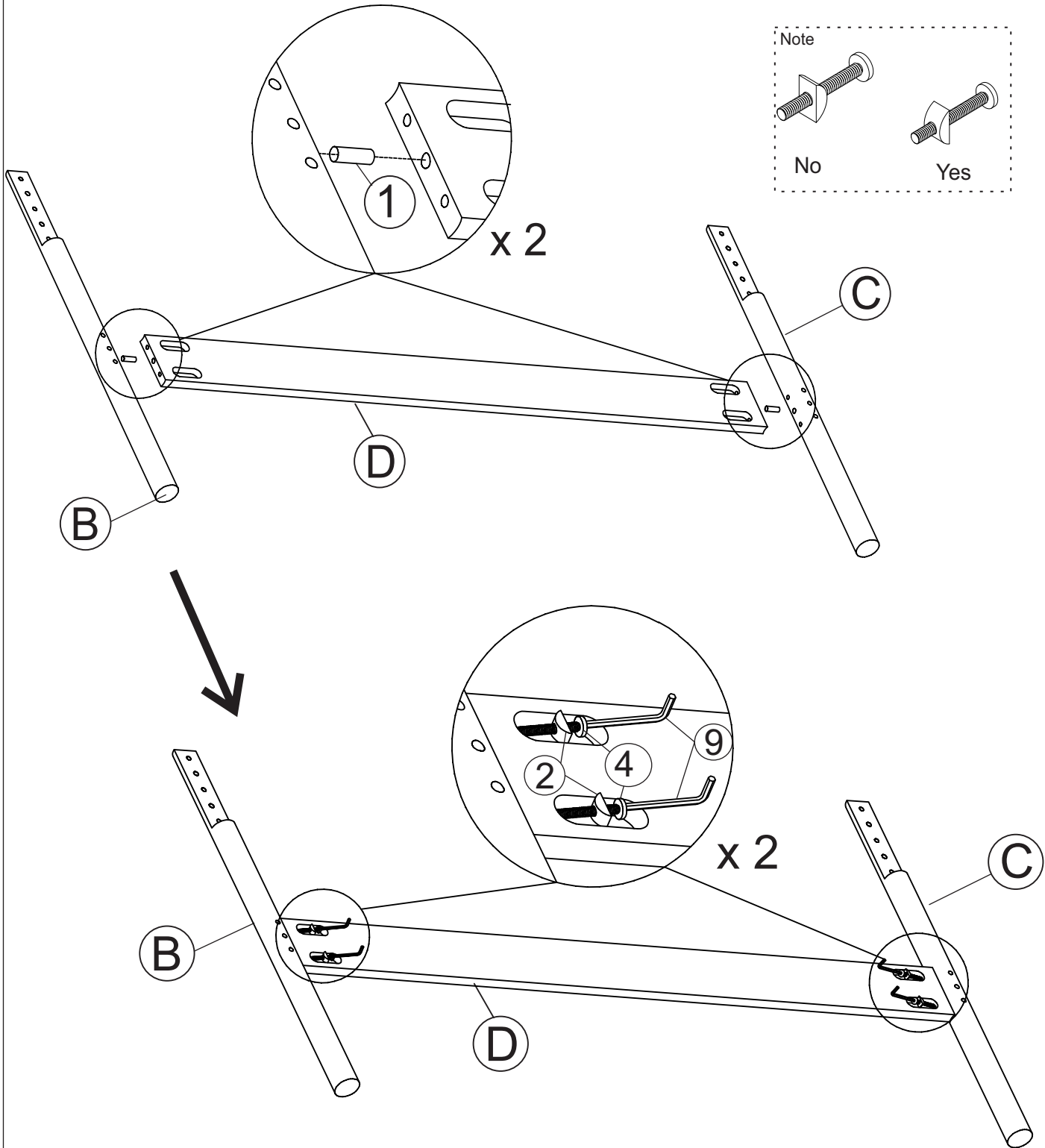

Align the mounting position of the Cross Bar (D), the Headboard Leg -L (B) & Headboard Leg -R (C) with wooden dowel (①). Attach the Cross Bar (D) to the Headboard Leg -L (B) & Headboard Leg -R (C) by using Long Bolt (④) and Half moon Nut (②) with Allen Wrench (⑨).

DO NOT FULLY TIGHTEN BOLTS.

Step 3

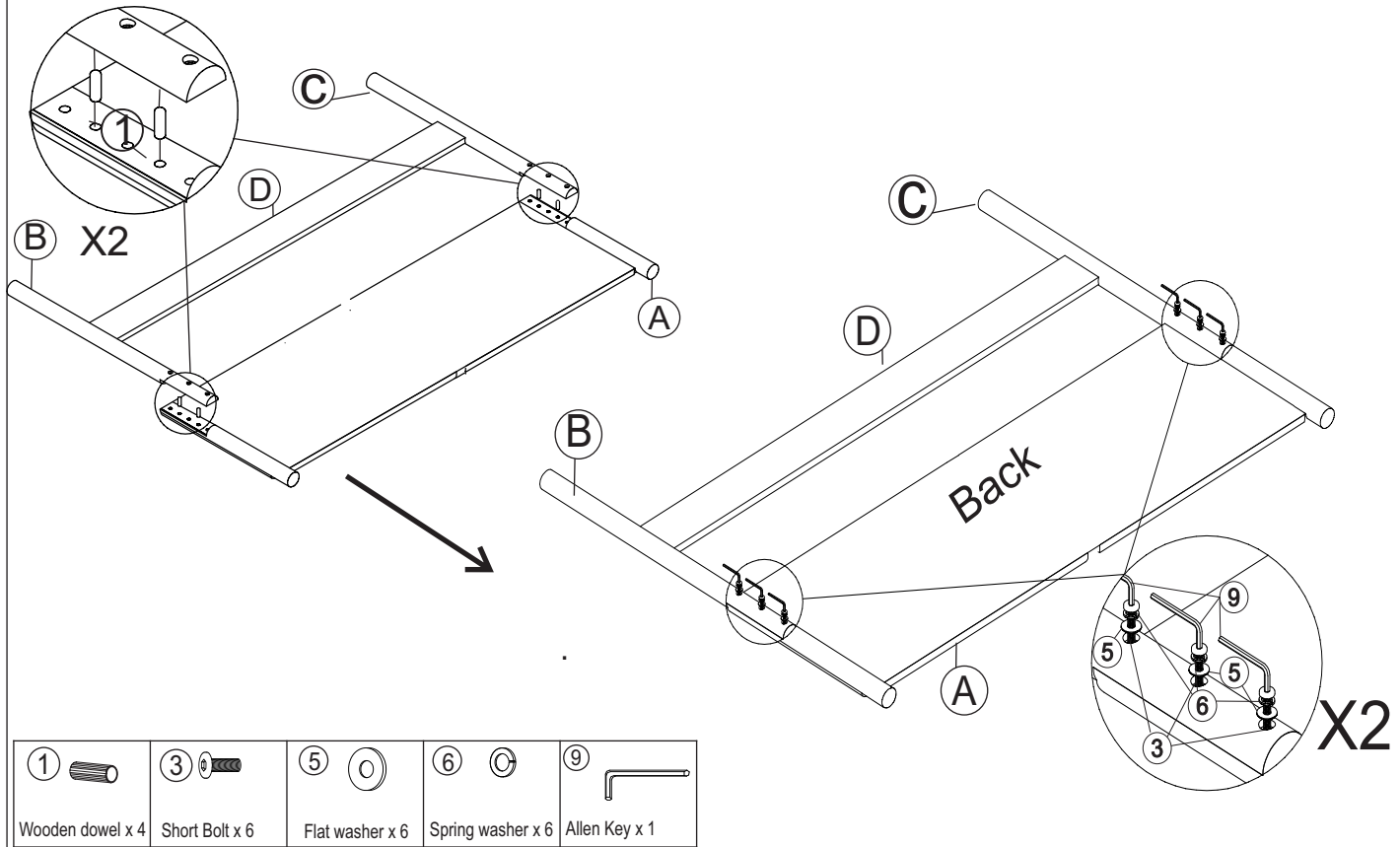

Align the the mounting position of Headboard (A) and the two Headboard legs (B) &(C) with wooden dowel (①) , Attach Headboard (A) to assembled Headboard legs (B) &(C) by using a short bolt (③), Spring Washers (⑥) and Flat Washers (⑤) with Allen Wrench(⑨) .

Step 4

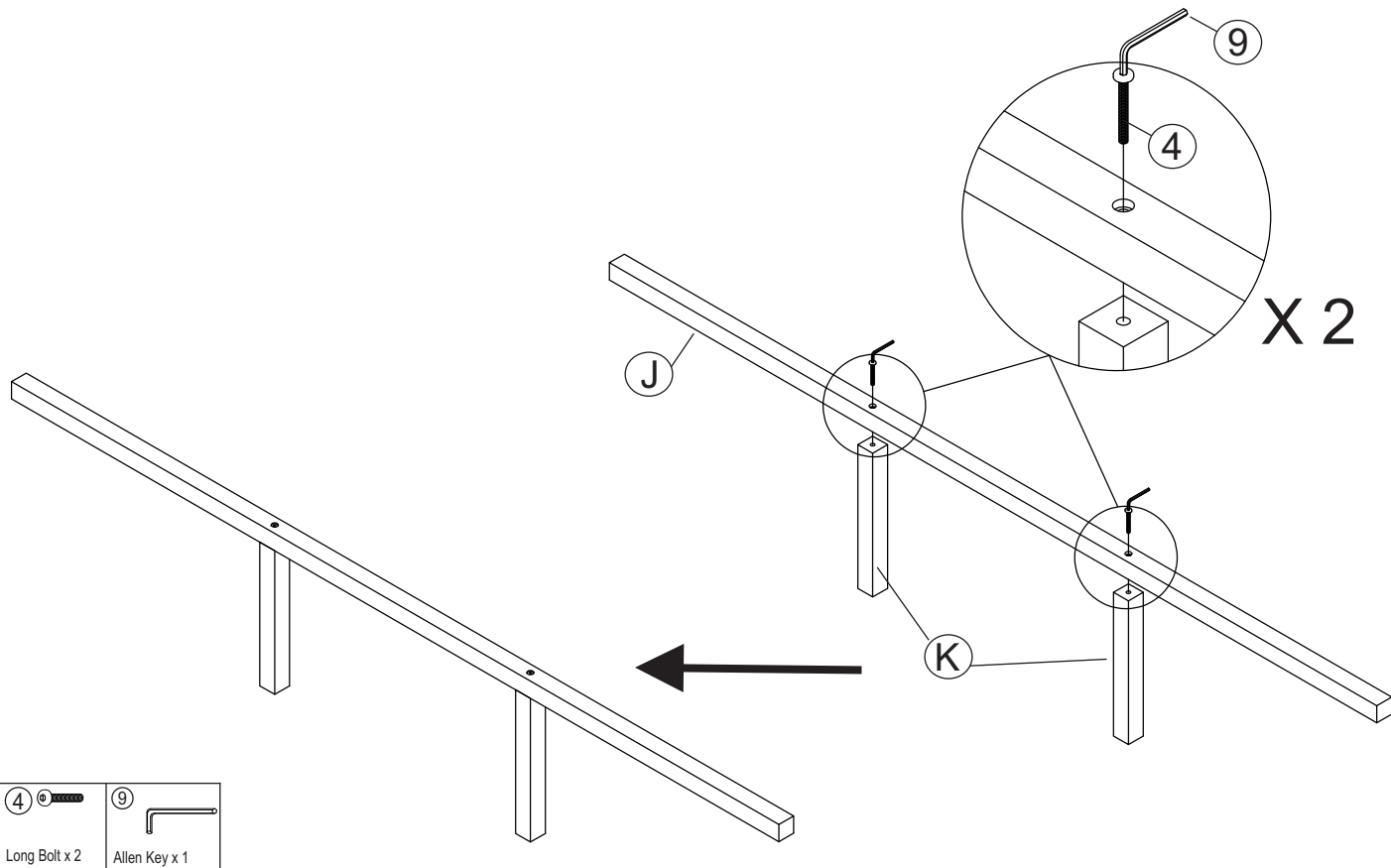

Attach the Center Leg (K) to the Slat Support (J) by Long Bolt (④) with Allen wrench (⑨).

Step 5

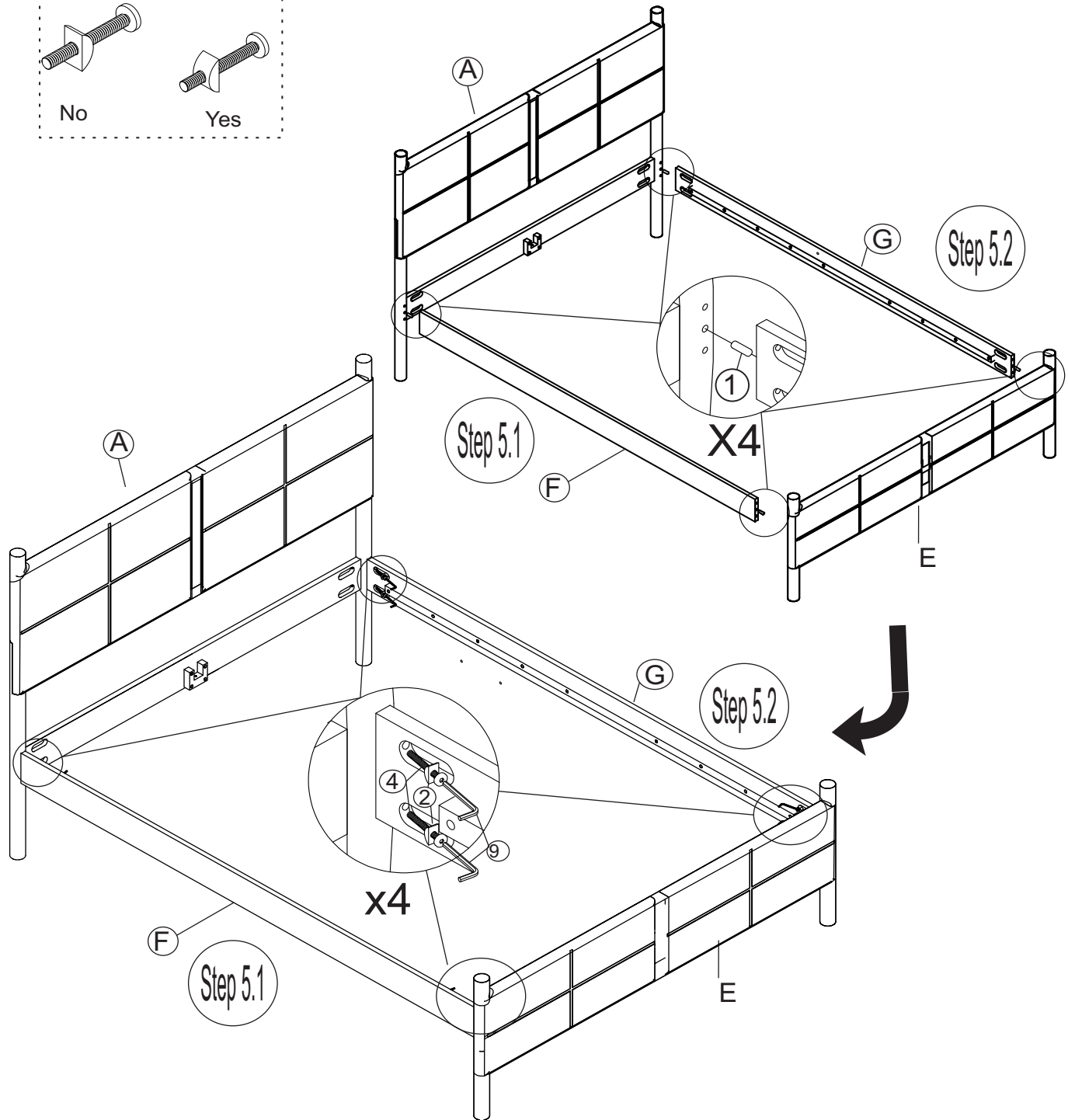
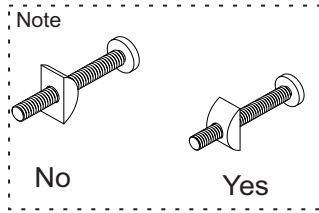

①	②	④	⑨
Wooden dowel x 4	Half moon Nut x 8	Long Bolt x 8	Allen Key x 1

With the help from you partner, stand the assembled headboard(A) as shown in picture above.

5.1 Align the mounting position of Side Panel -L (F) and the assembled Headboard (A) and Footboard (E) with with wooden dowel (①). Attach the Side Panel -L (F) to the assembled Headboard (A) and Footboard (E) by using Bolts (④), Half moon nut (②) with Allen Wrench (⑨).

5.2 Repeat the same step to attach the Side Panel-R (G) to the assembled Headboard (A) and Footboard (E).

DO NOT FULLY TIGHTEN BOLTS.

Step 6

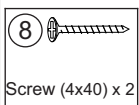
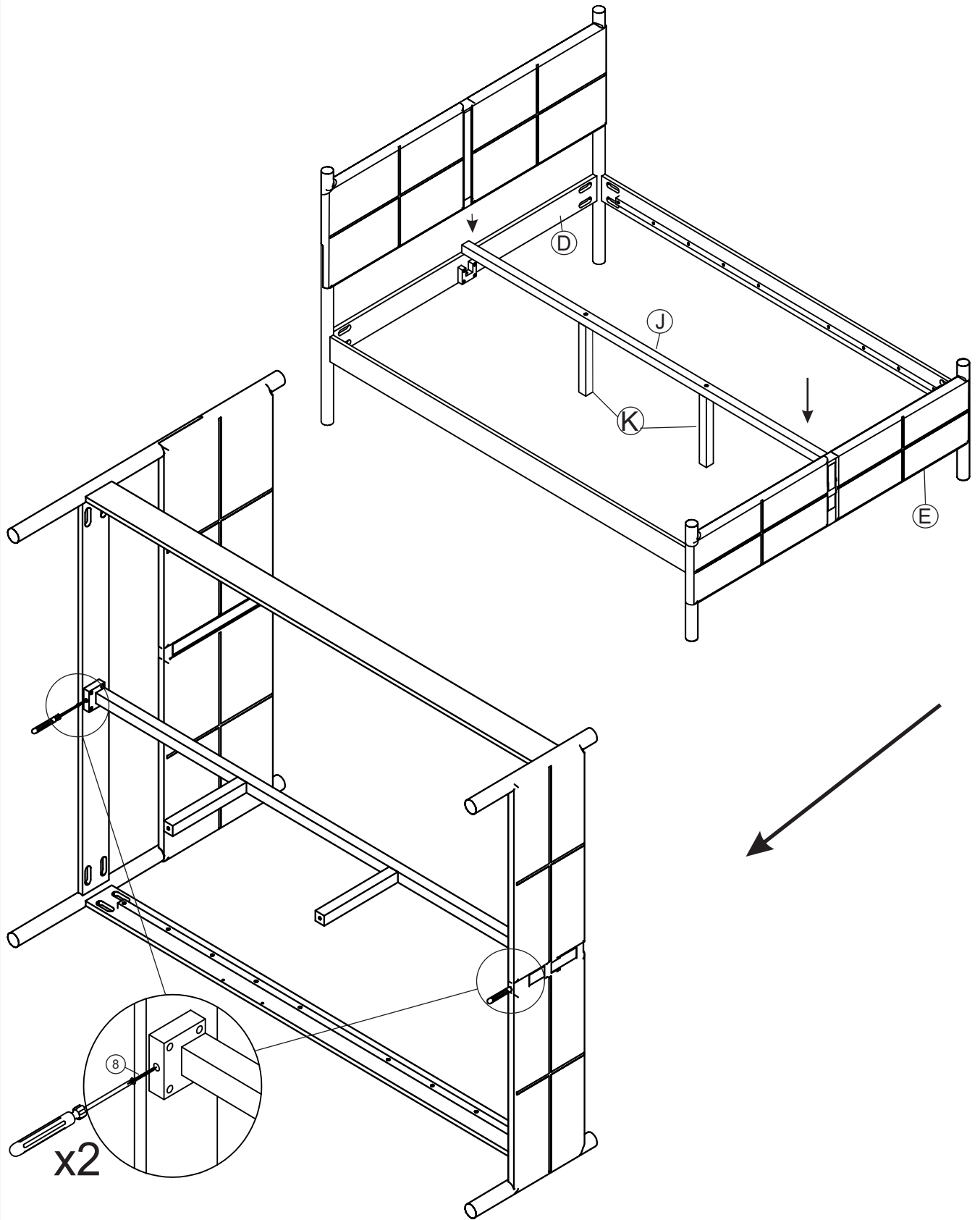

Attach the Slat support (J) to Cross Panel (D) and Footboard (E) by using Screw (⑧) with screwdriver (Not provided). 10/12

Step 7

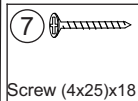
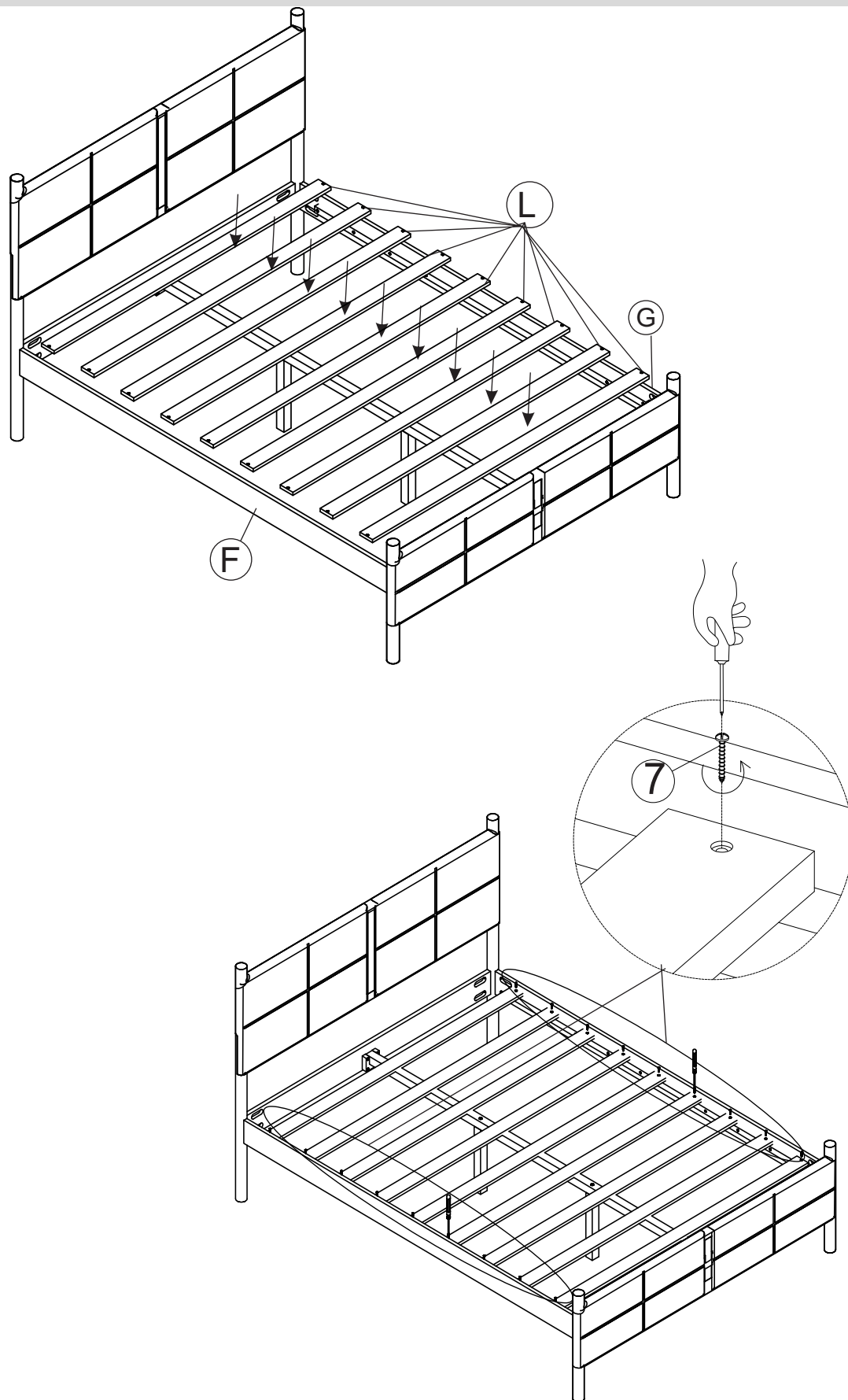

And now for the final step !

Attach all slats (L) to the rail on Side Panel -L(F) and Side Panel -R (G) by using Screws (7) and Screwdriver (Not Provided).

Step 8

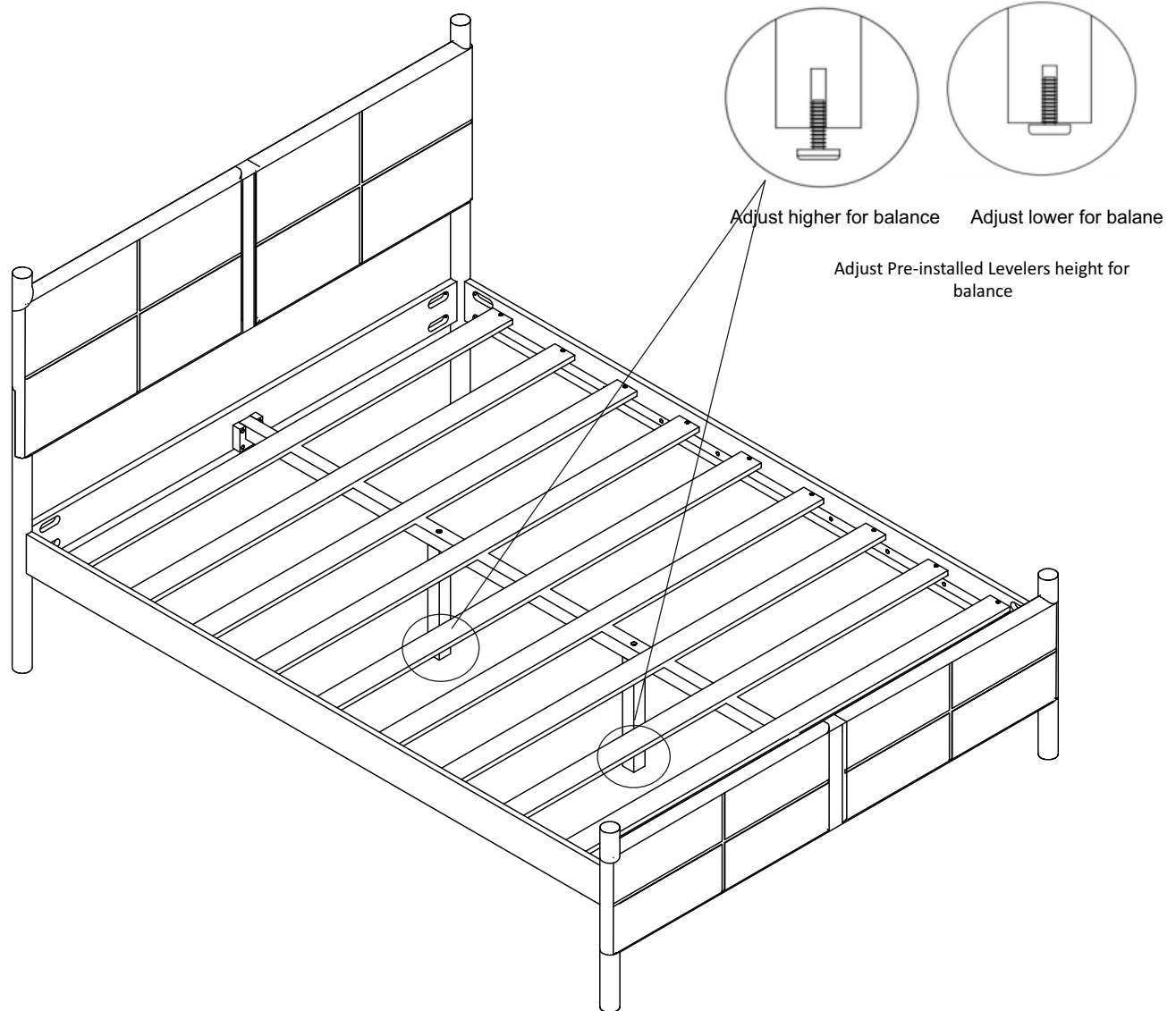

- Place the Bed on a LEVEL SURFACE.
- In a sequential manner, gradually tighten all Bolts until evenly secured.
- **When tightening these bolts, tighten sequentially. DO NOT tighten any bolt fully and then towards the next one. This would cause the frame to warp.**
- **Inspect the Bed and make sure all parts are adequately connected.**
- With assistance from your adult partner, adjust the Levelers to desired height to avoid wobbles.
- To adjust the Levelers, get assistance from an adult partner to lift/ lean and hold the Bed while you are working.
- Your Bed is ready for use.
- **This Bed can only be used on a flat, level surface.**