

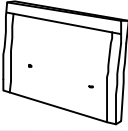

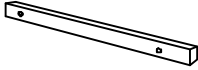

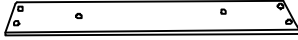





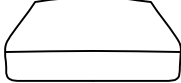

ASSEMBLY INSTRUCTION

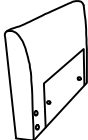
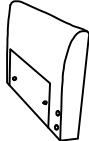
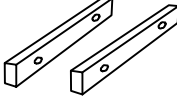
A Backrest x1 	B Support bar x2 	D Front panel x1 	K Bottom panel x1 	
E Back cushion x1 	F Arm pillow x2 	G Seat cushion x1 	H Leg x4 	
Y Armrest-L x1 	J Armrest-R x1 	T Armrest support rod x2 	M Wrench x1 	
Z Corner Iron x4 	X L shape Iron x2 	N Washer x28 	O Bolt 8*50 x 8 	L Bolt 8*25 x 20 

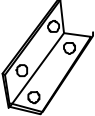
STEP 1

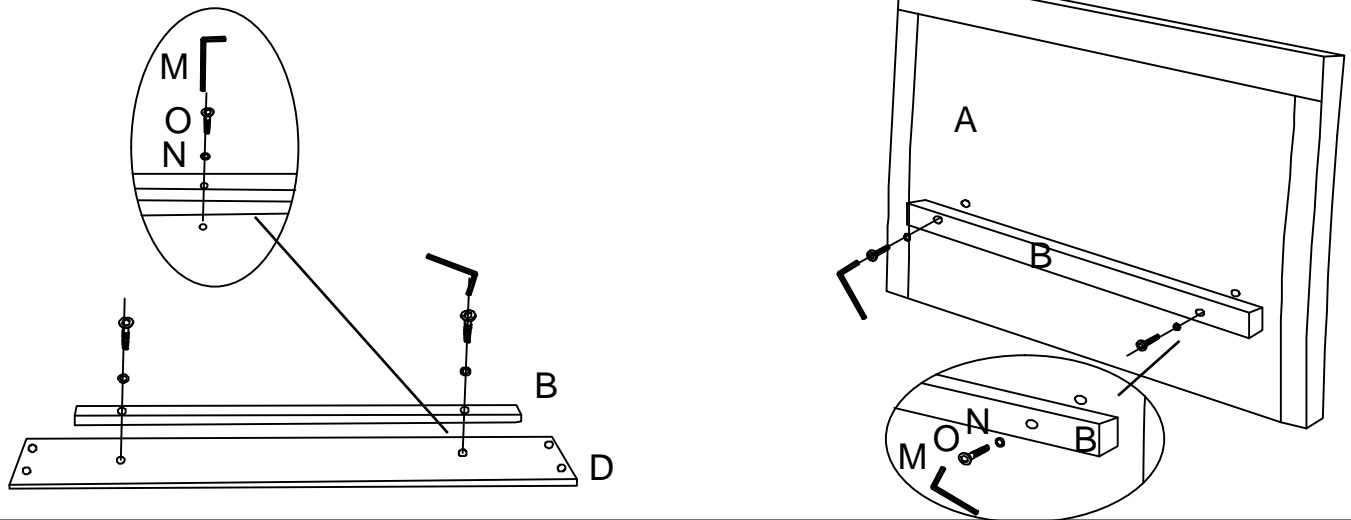

STEP 2

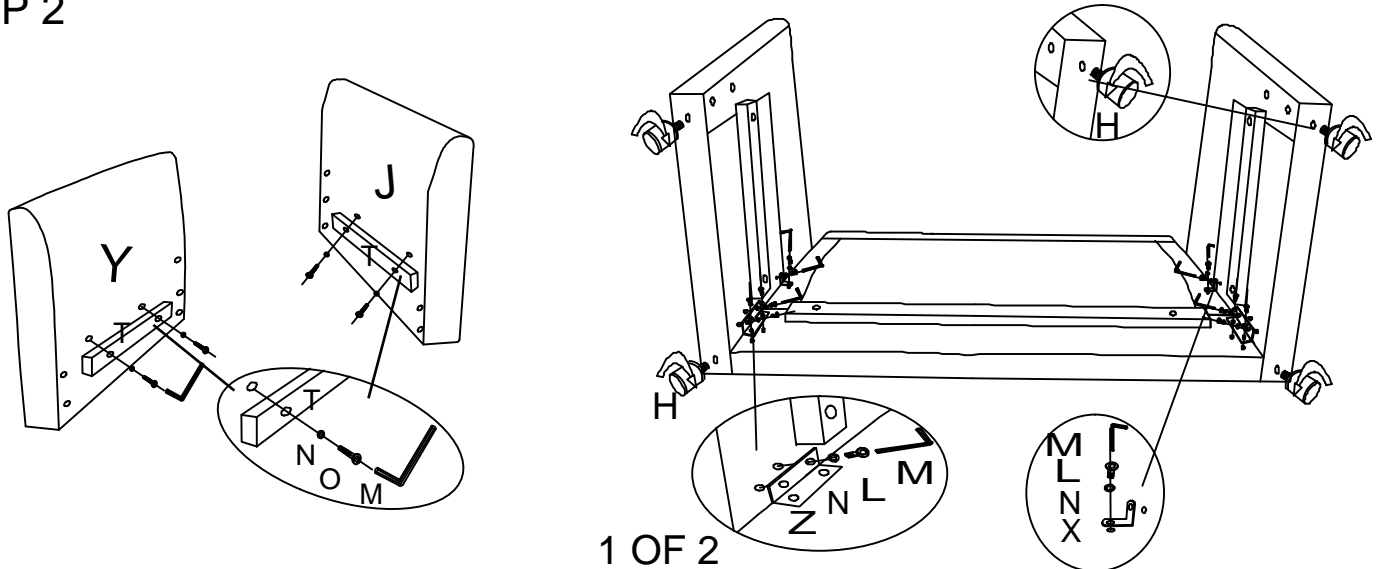

STEP 3

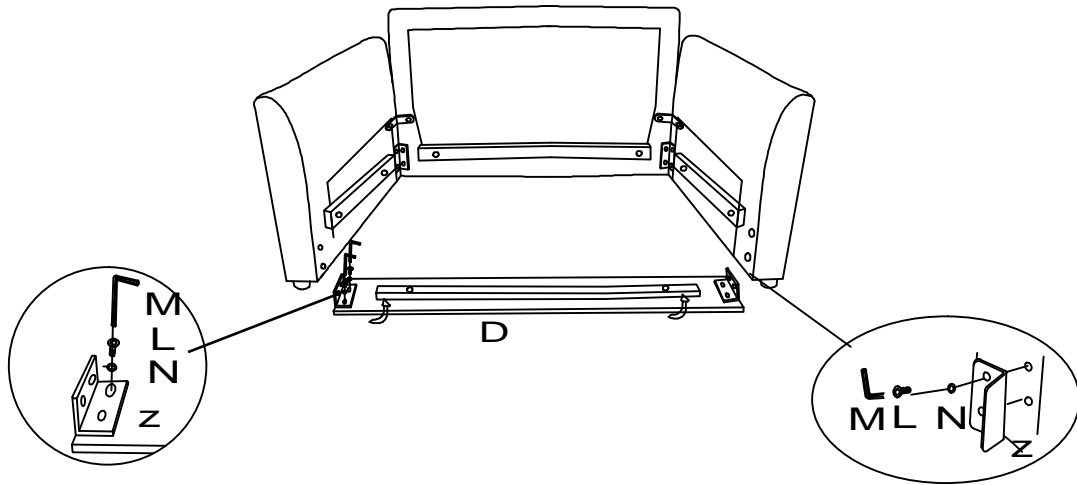

STEP 4

