

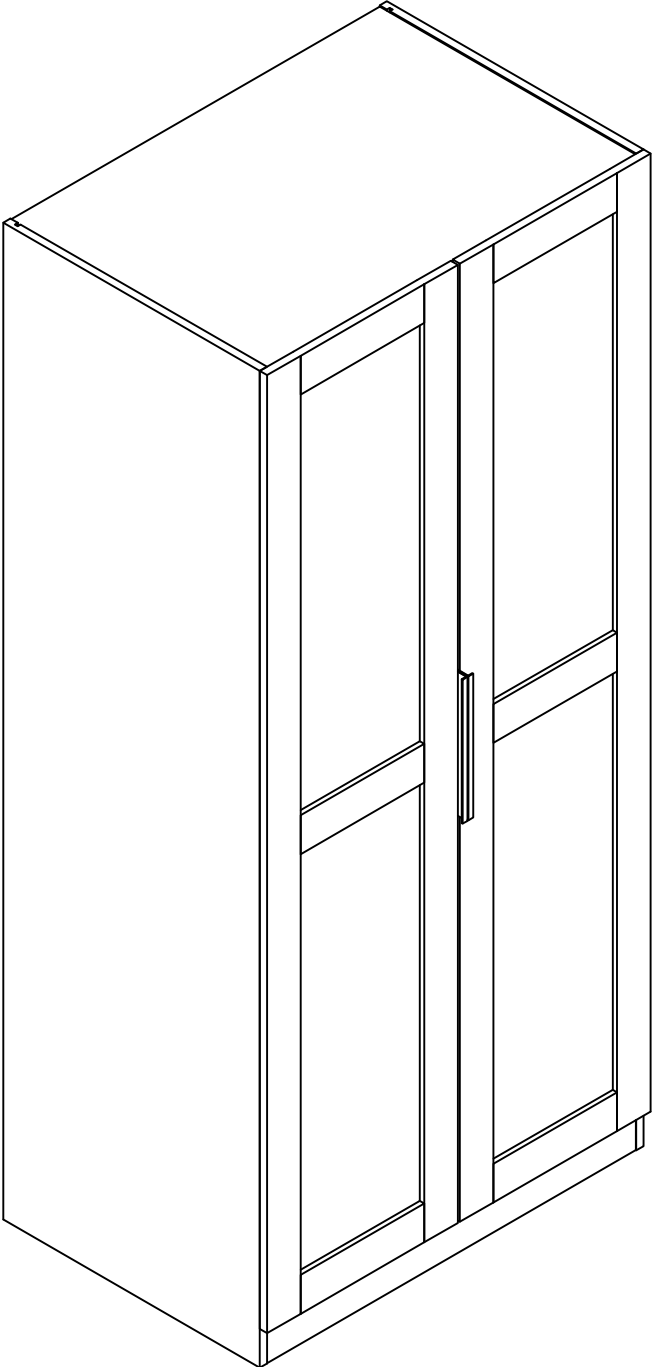

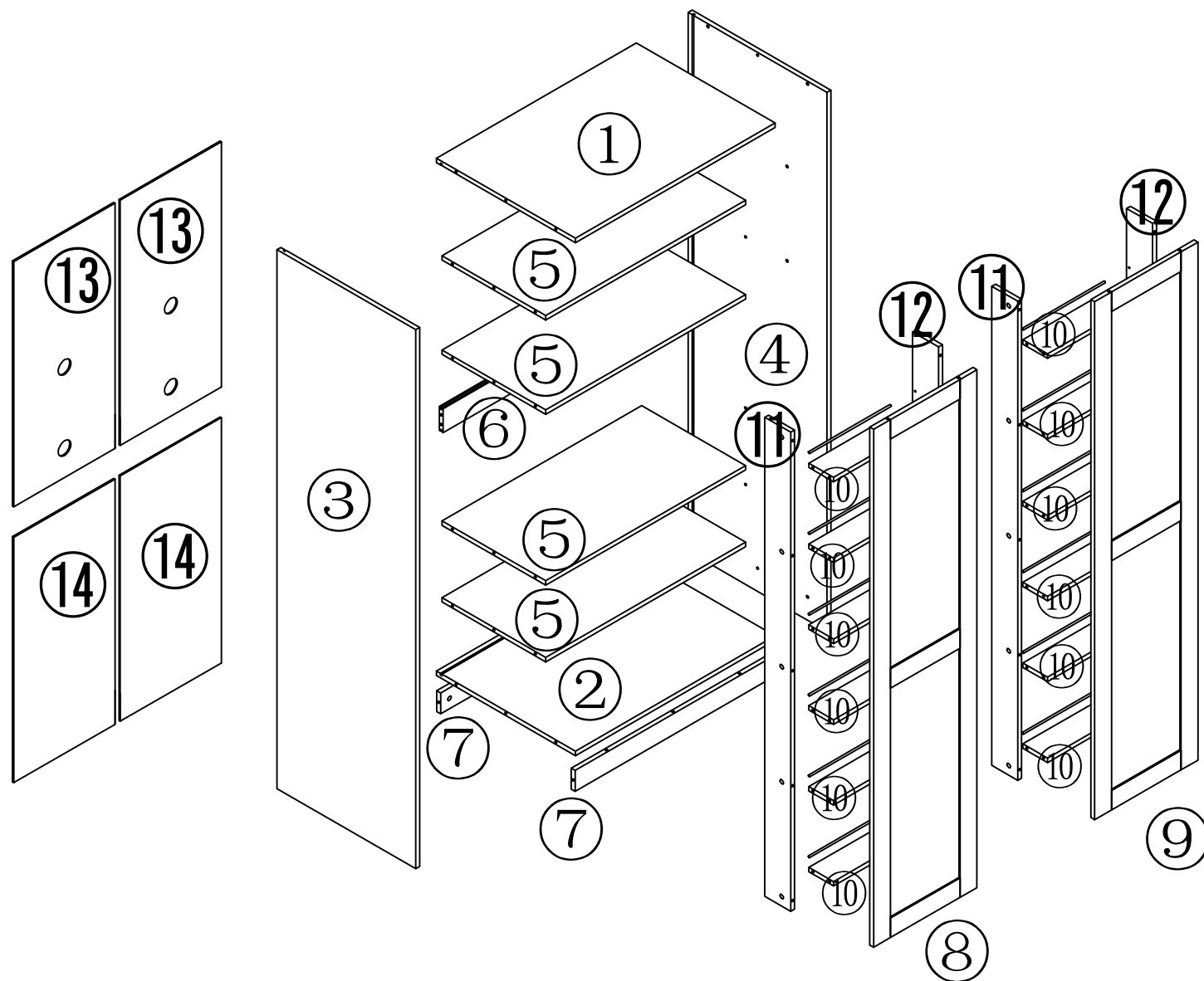



Installation & Assembly



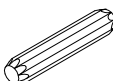
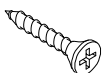
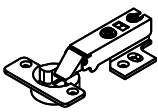

<p>A</p>  <p>106PCS</p>	<p>B</p>  <p>106PCS</p>	<p>C</p> <p>8*40</p>  <p>12PCS</p>	<p>D</p> <p>3.5*14</p>  <p>52PCS</p>	<p>E</p>  <p>8PCS</p>	<p>F</p>  <p>2PCS</p>	<p>G</p>  <p>12PCS</p>	<p>H</p> <p>3*12</p>  <p>12PCS</p>	<p>I</p>  <p>12PCS</p>	<p>J</p>  <p>2PCS</p>
--	--	---	---	---	--	---	---	---	--

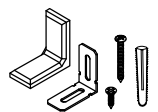
1

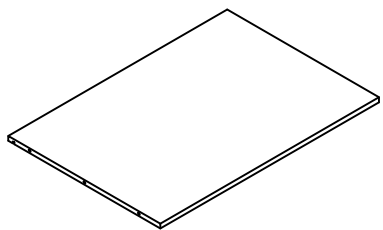

770*535 1PC

2

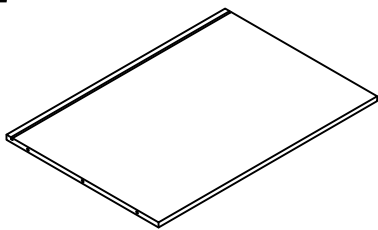

770*535 1PC

3

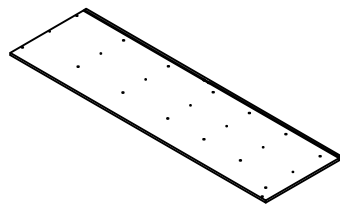

1600*535 1PC

4

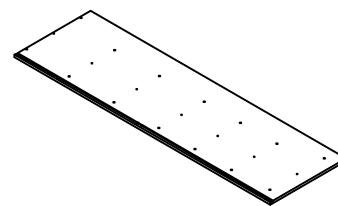

1600*535 1PC

5

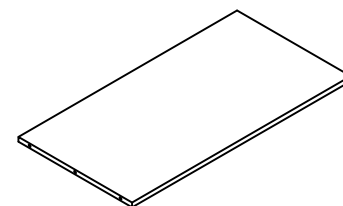

770*400 4PC

6

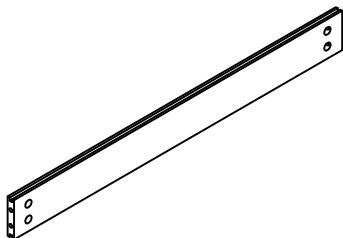

770*80 1PC

7

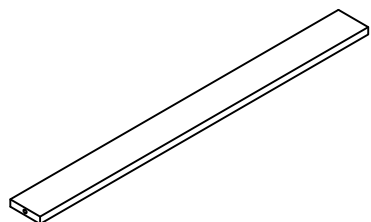

770*70 2PC

8

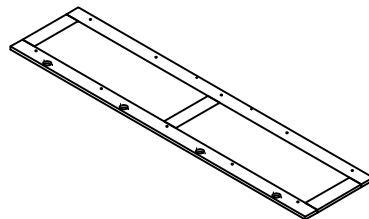

1530*398 1PC

9

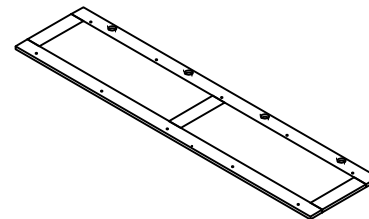

1530*398 1PC

10

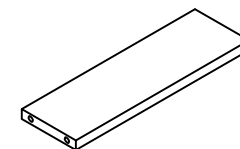

305*95 12PC

11

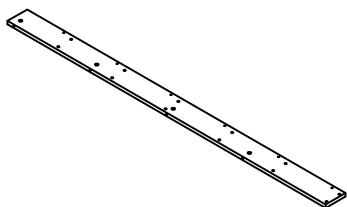

1400*100 2PC

12

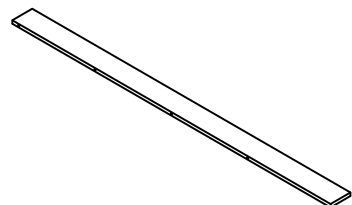

1400*100 2PC

13

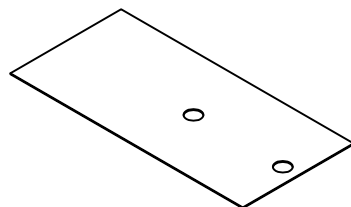

719*390 2PC

14

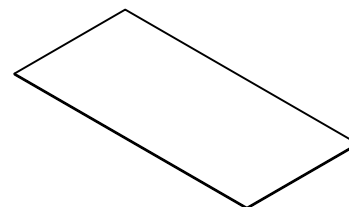

710*390 2PC

①

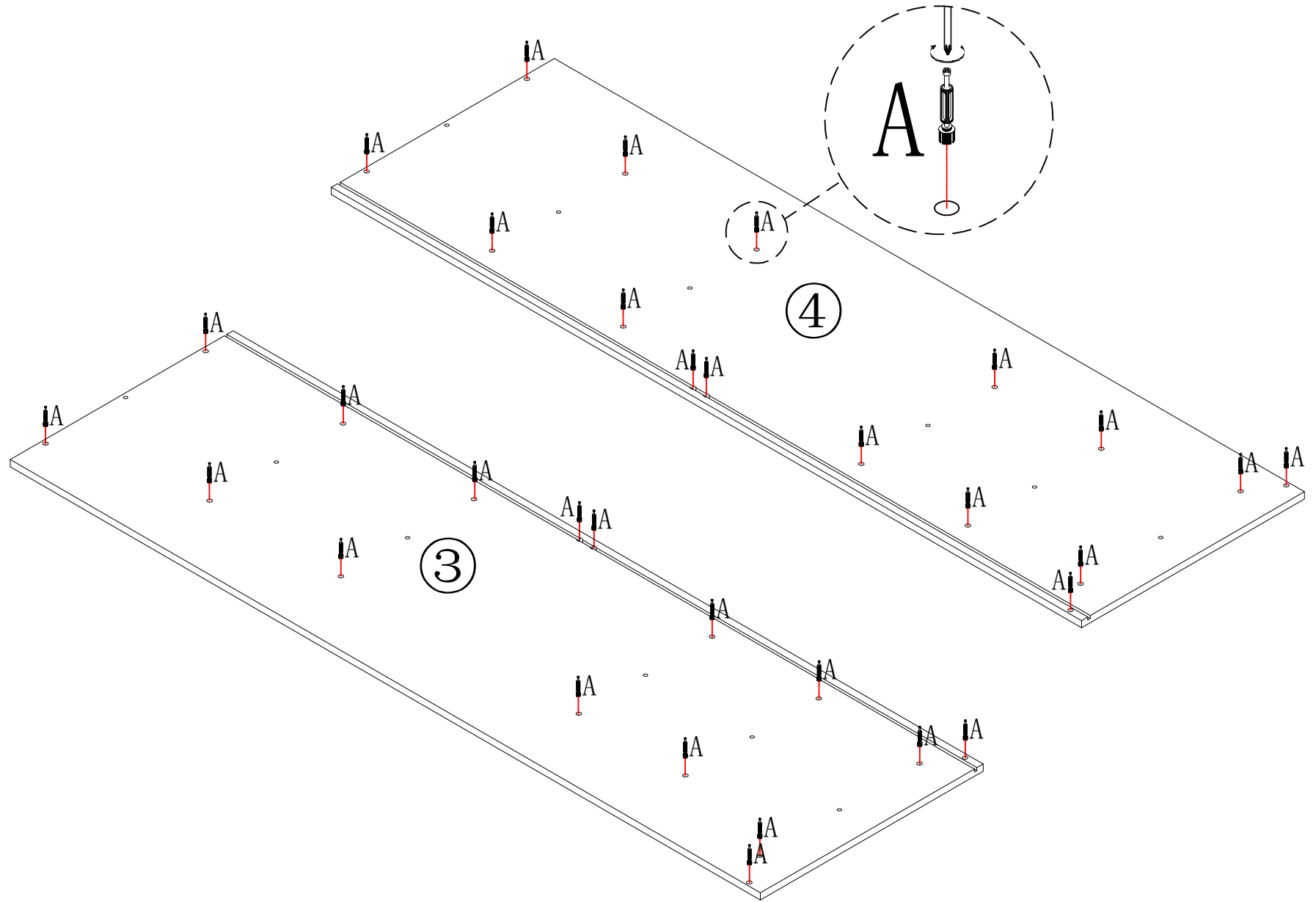

③

④





A*32

put A on board ③ ④

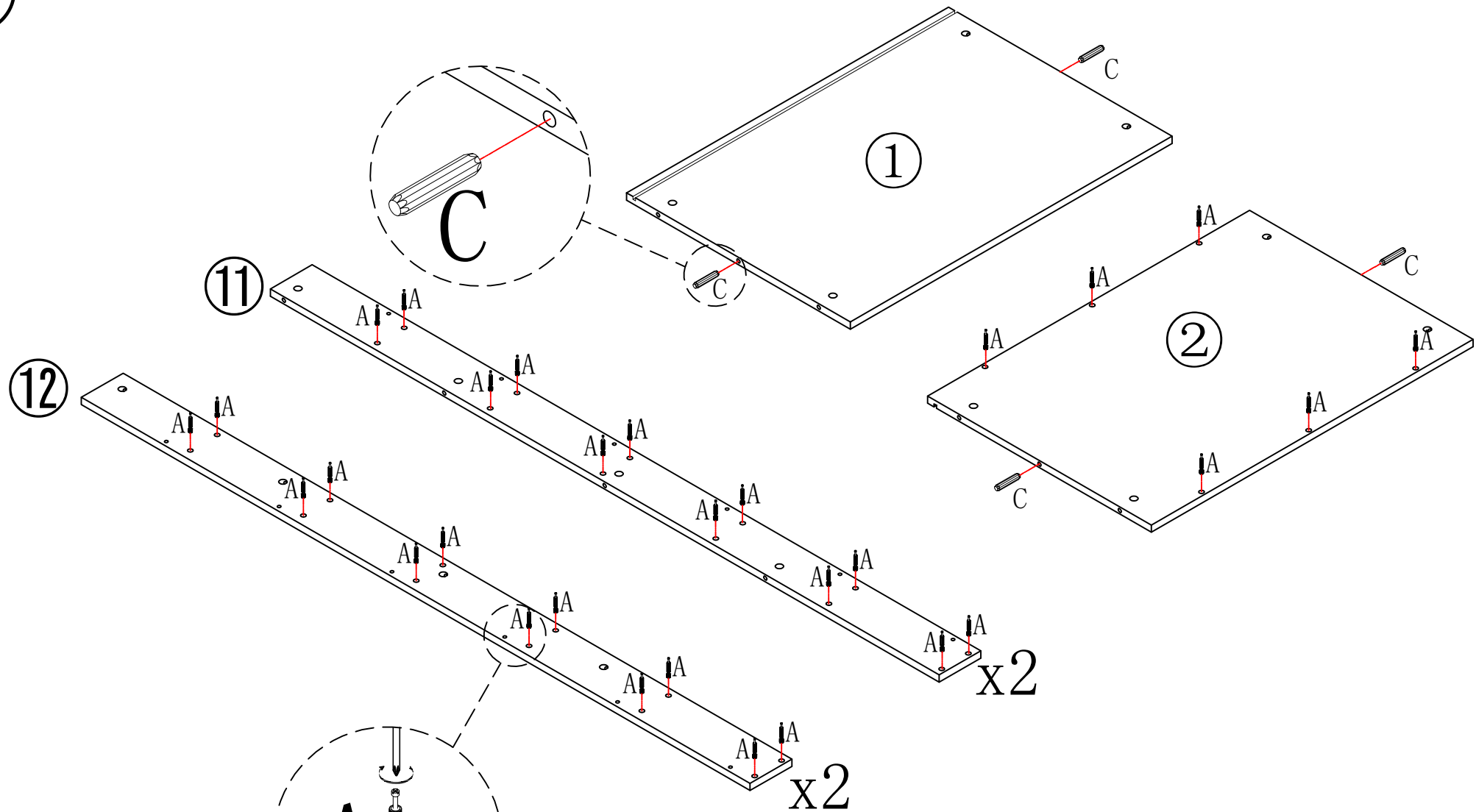
2







	A*54
	C*4

put A on board ② ⑪ ⑫

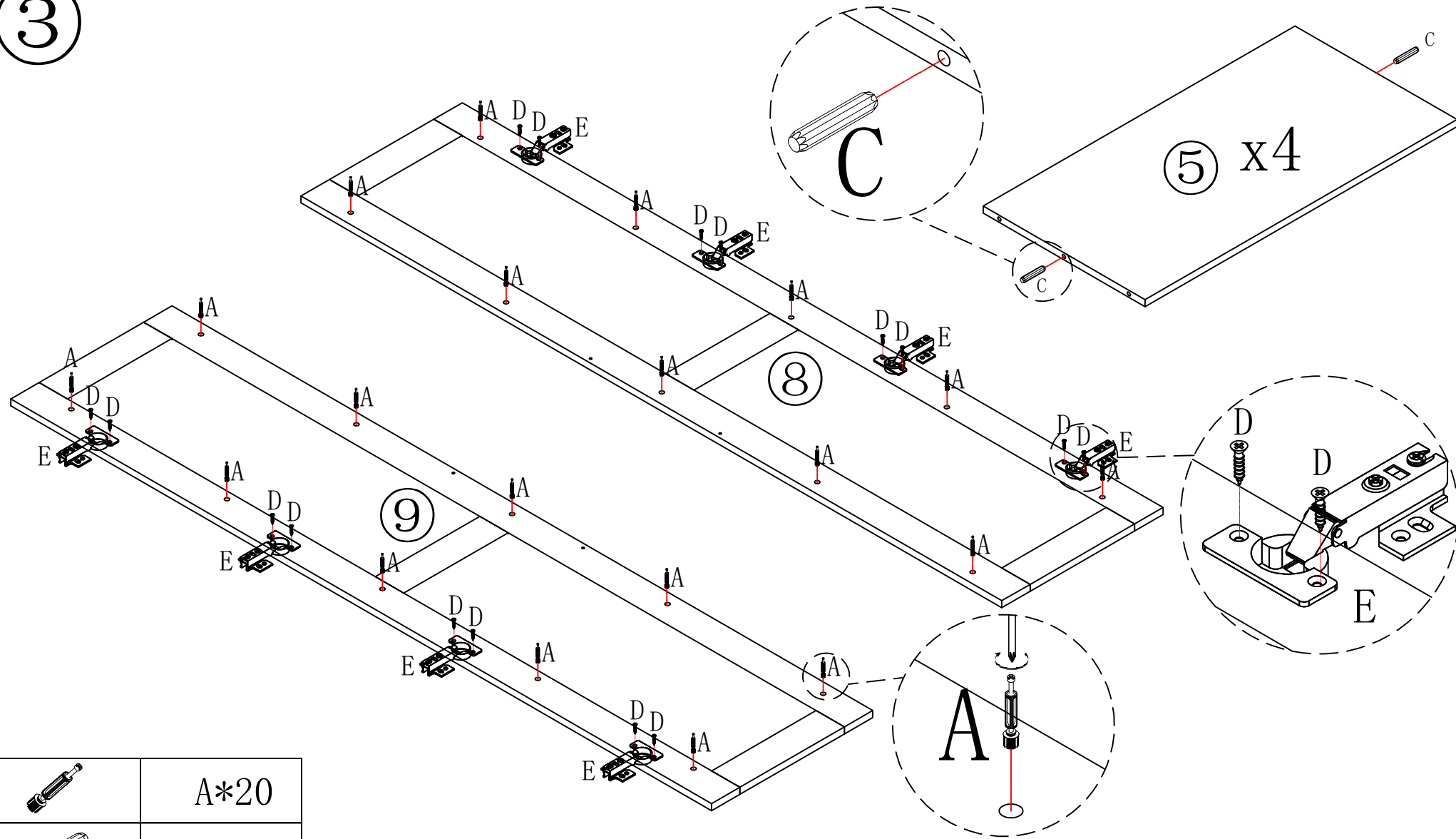
put C on board ① ②

③



	A*20
	C*8
	D*16
	E*8

put A on board ⑧ ⑨

put C on board ⑤

4

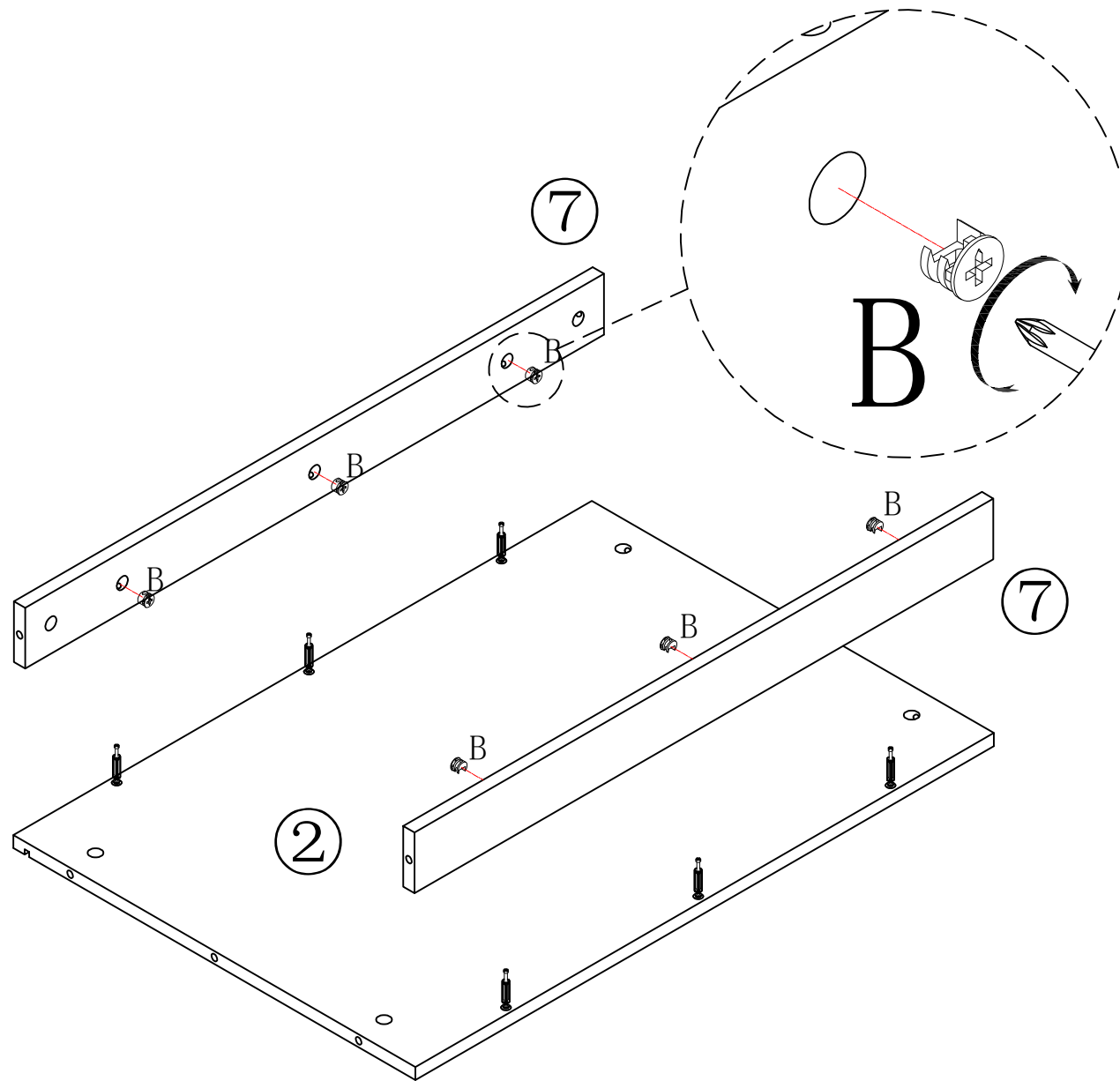

Make sure the arrow on the screw align to the hole on the side.
put B on board ⑦



B*6

5

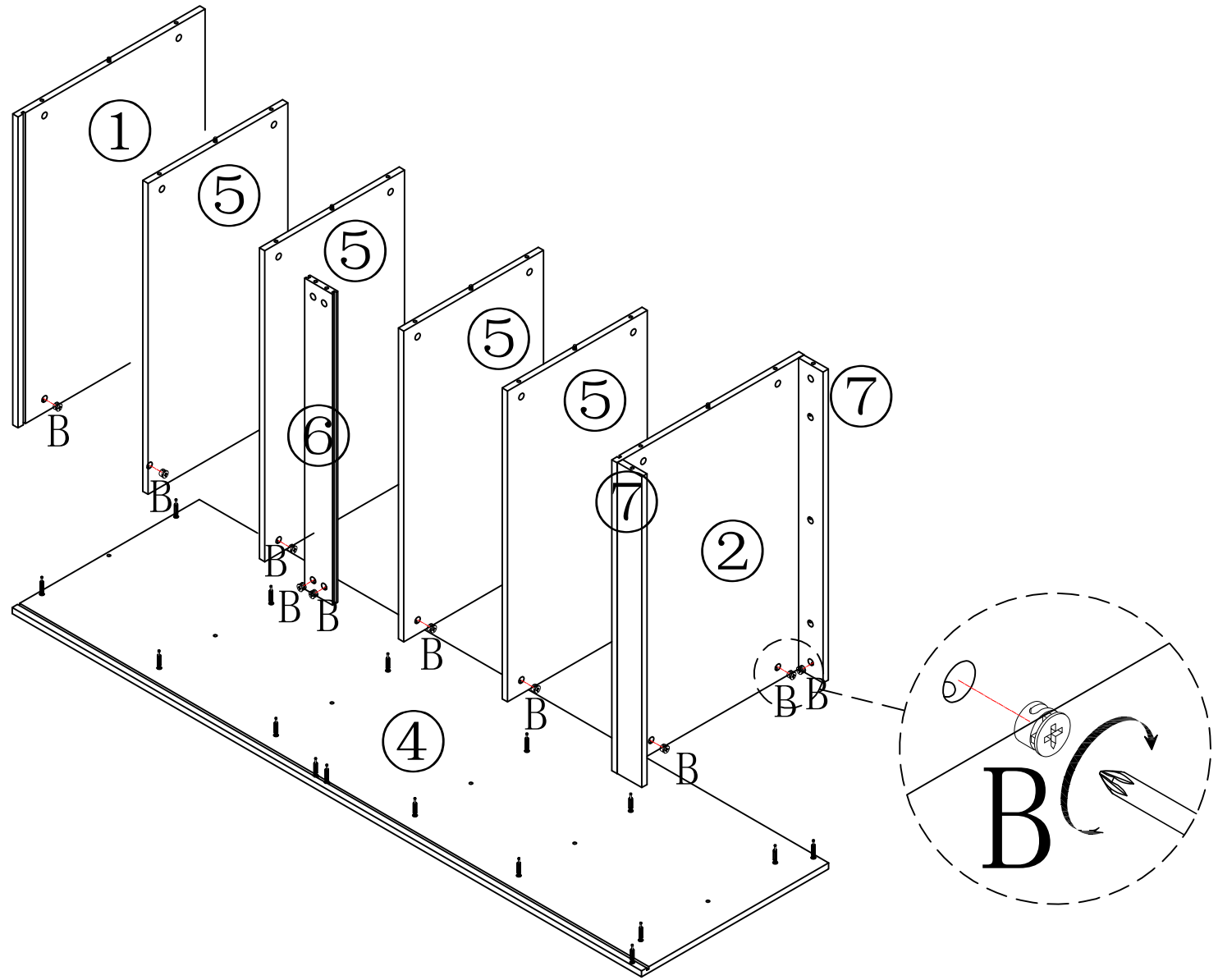

put B on board ① ② ⑤ ⑥ ⑦



B*16

6

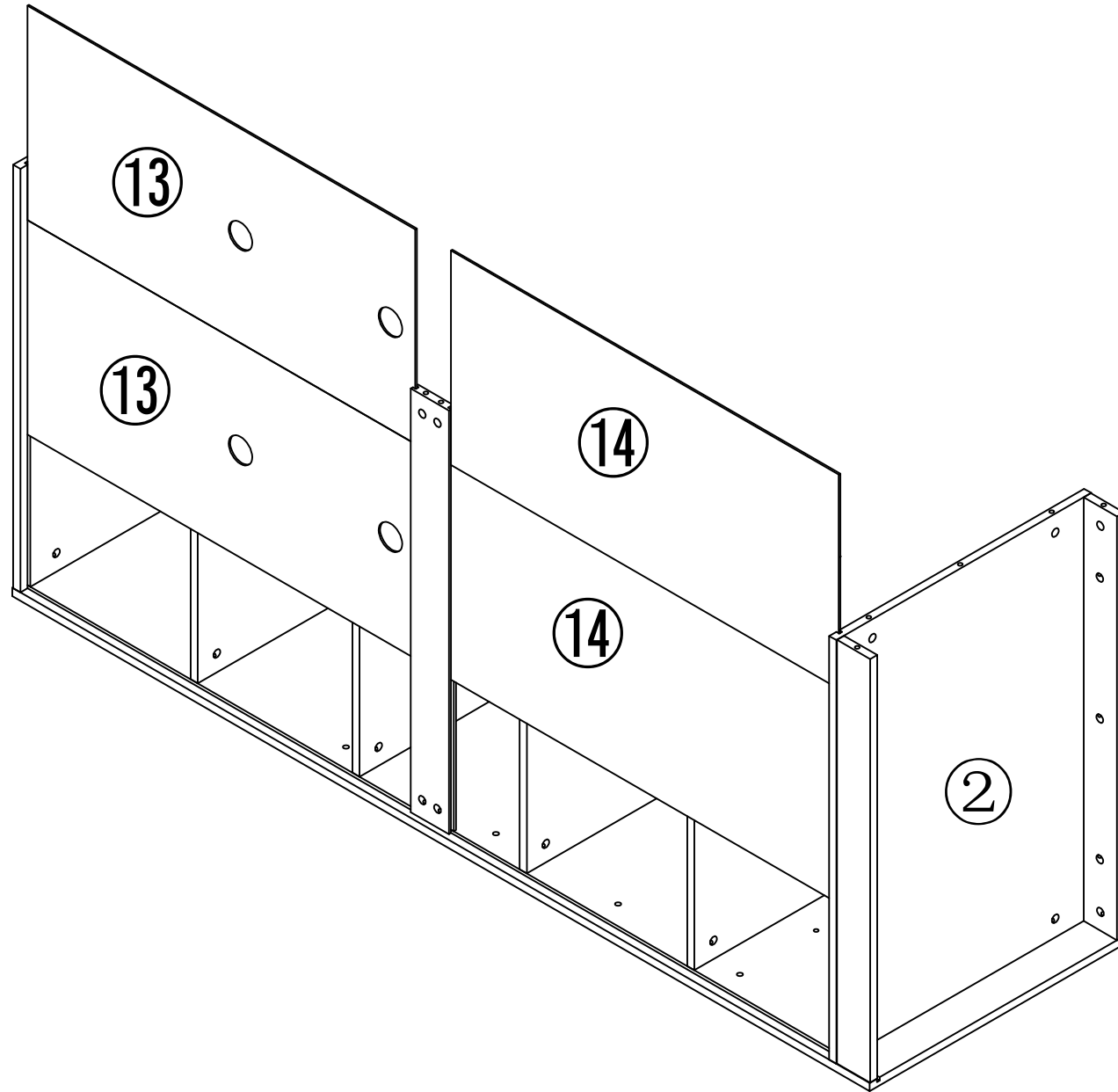

7

put B on board ① ② ⑤
⑥ ⑦

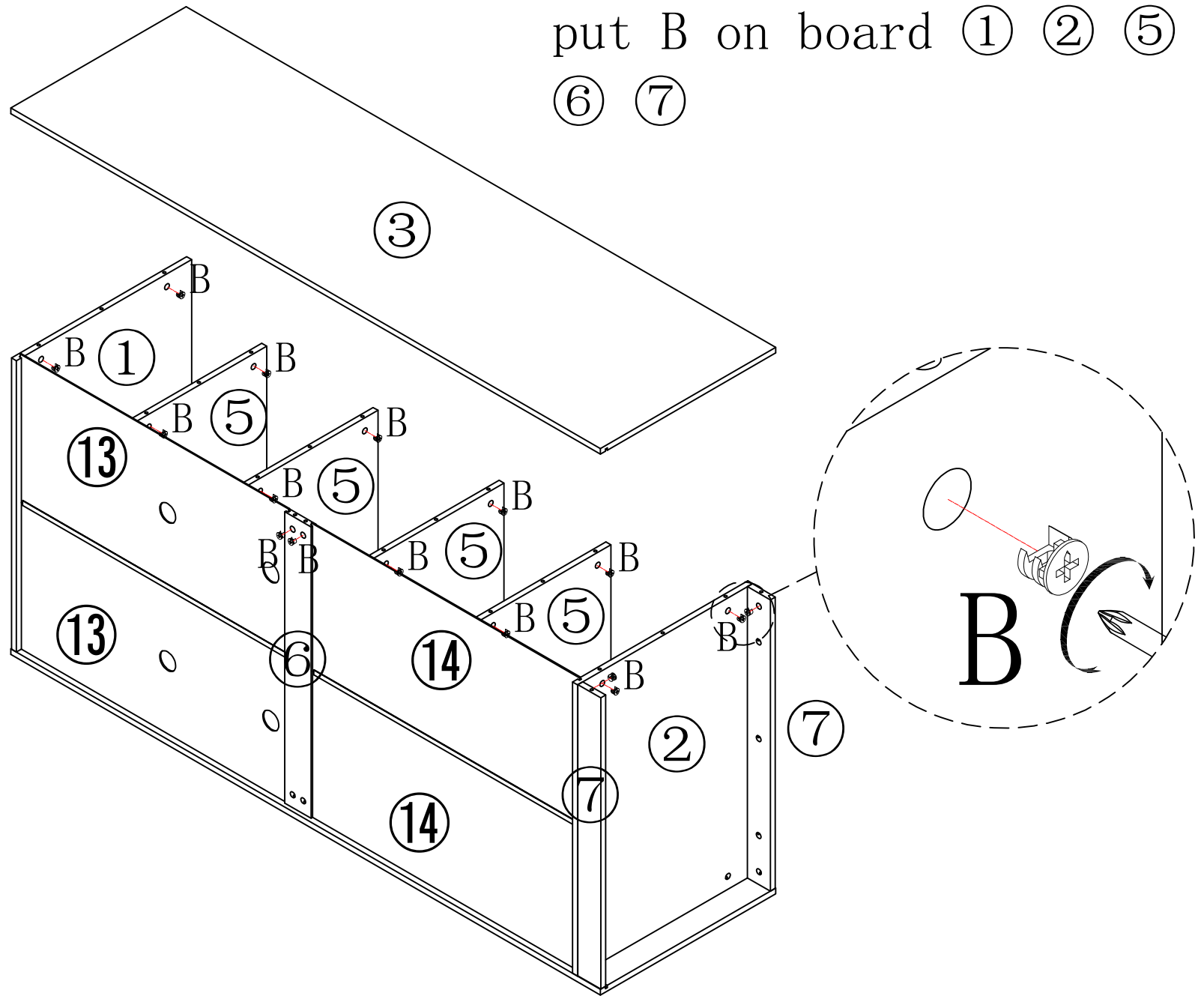



B*16

8

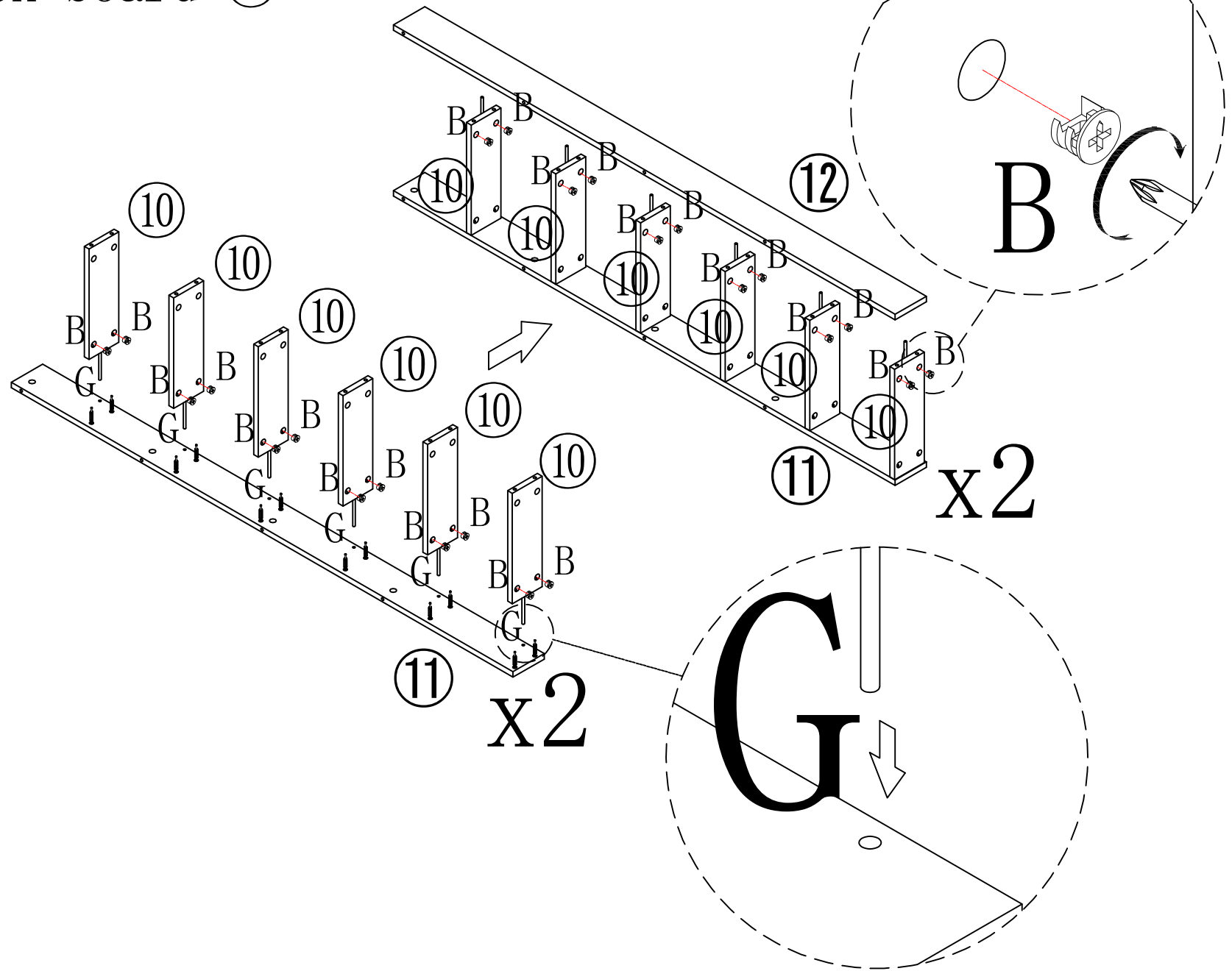
put B on board 10



	B*48
	G*12

9

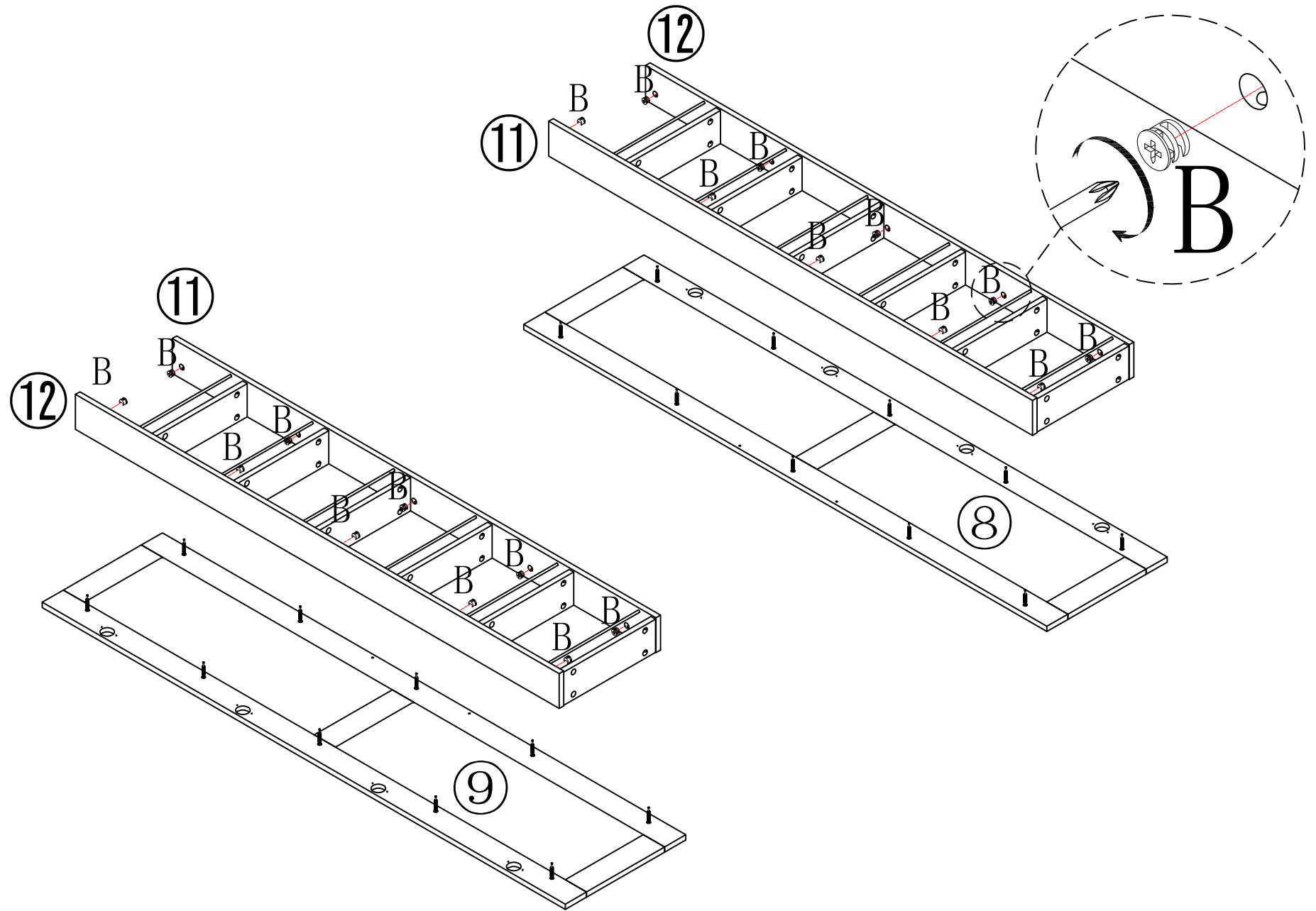





put B on board 11 12

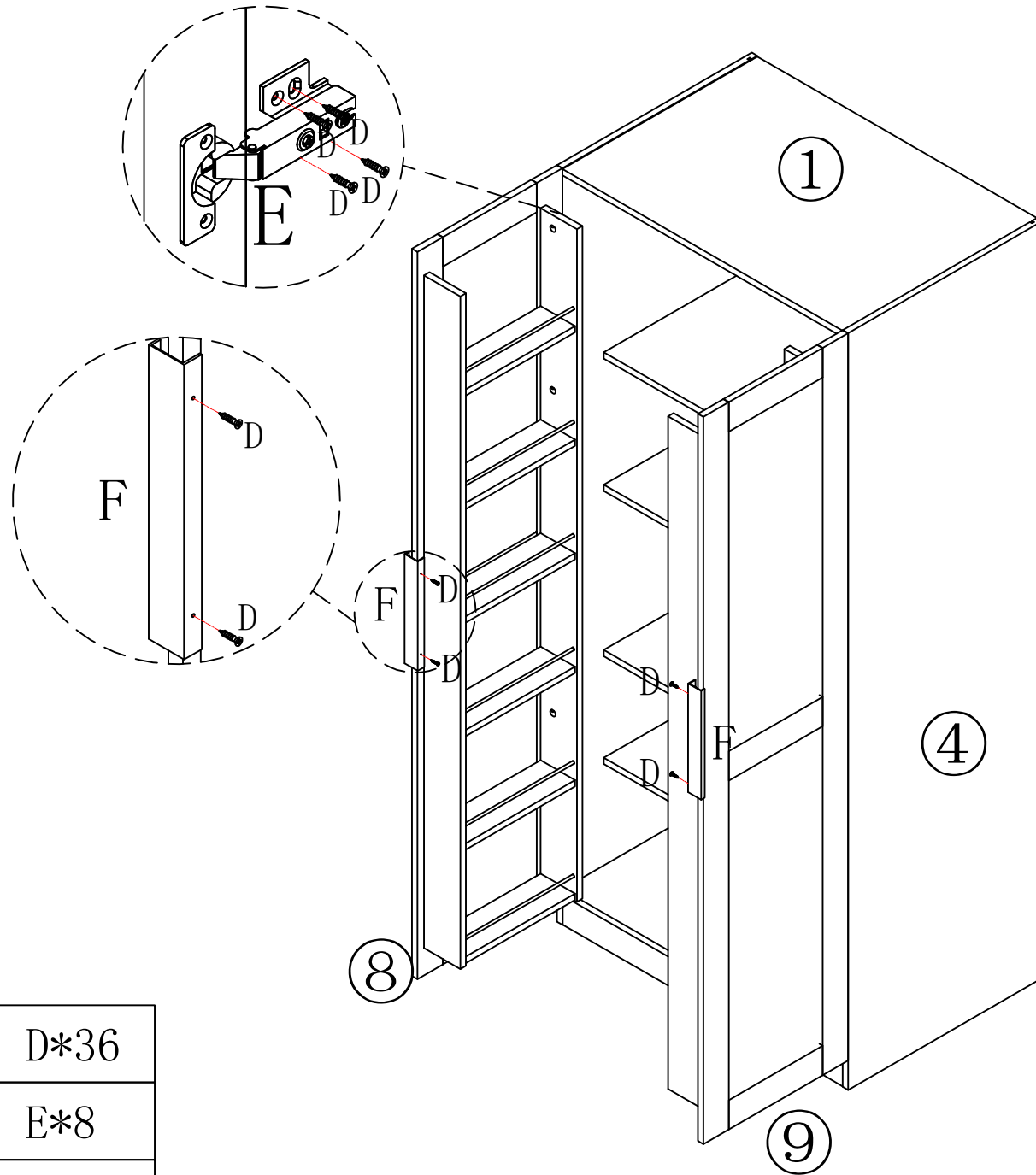

B*20



10

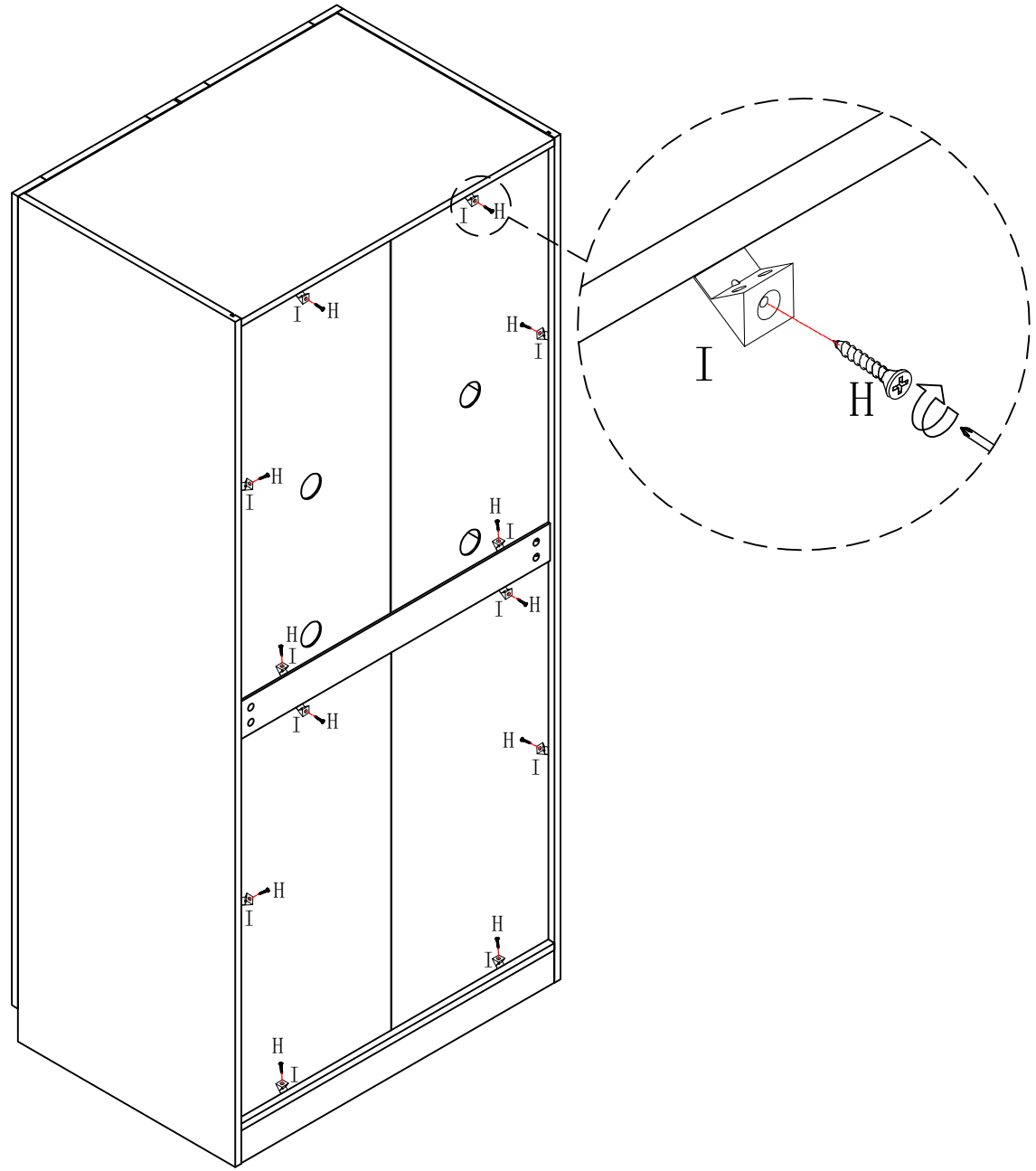

	D*36
	E*8
	F*2

11



	H*12
	I*12

12

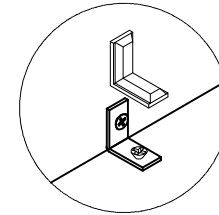
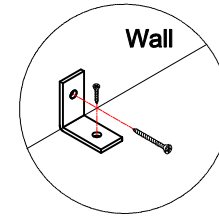
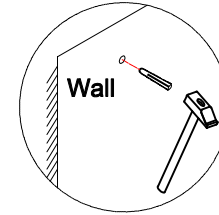
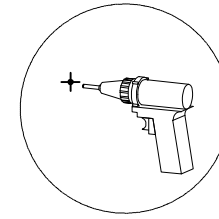
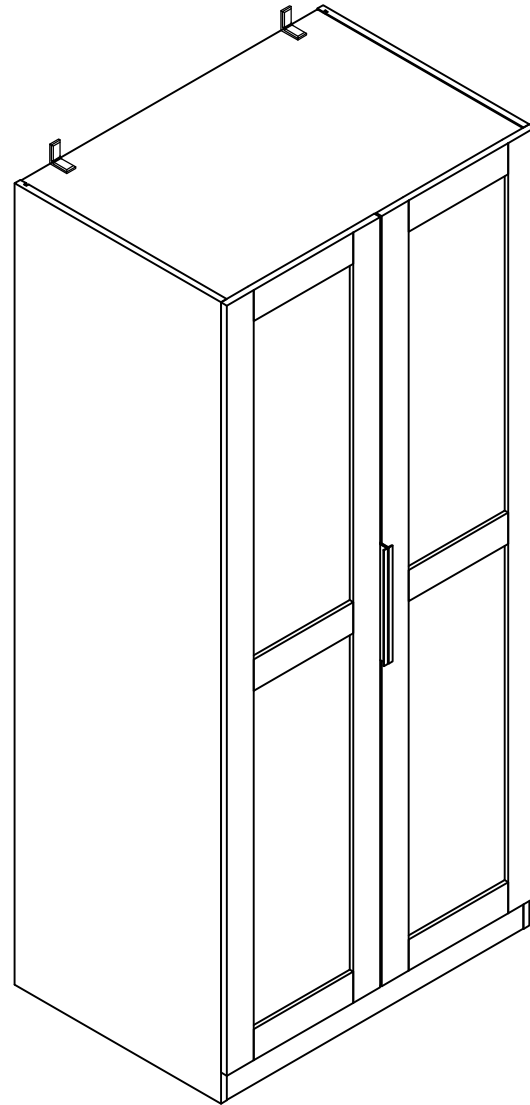

Please install tip-proof fitting.



J*2

