

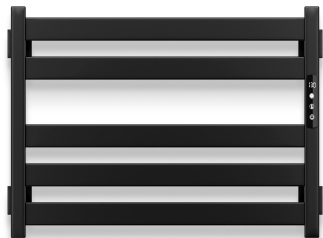

Installation & Operation for Electric Towel Warmer

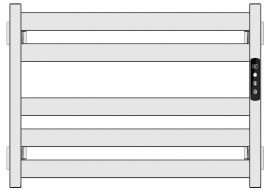





APPLICABLE MODELS	BARS	FINISH	VOLTAGE	WATTAGE	TEMPERATURE	TIMER	MATERIAL
AY1001	5	Matte Black	110V	70W	115-155°F	1-9 Hours	201 Stainless Steel
AY1006	5	Mirror Polished	110V	70W	115-155°F	1-9 Hours	304 Stainless Steel
AY1002	8	Matte Black	110V	115W	115-155°F	1-9 Hours	201 Stainless Steel
AY1005	8	Mirror Polished	110V	115W	115-155°F	1-9 Hours	304 Stainless Steel
AY1009	8	Matte Black	110V	115W	115-155°F	1-9 Hours	201 Stainless Steel
AY1010	8	Mirror Polished	110V	115W	115-155°F	1-9 Hours	304 Stainless Steel
AY1007	10	Matte Black	110V	130W	115-155°F	1-9 Hours	201 Stainless Steel
AY1008	10	Matte Black	110V	130W	115-155°F	1-9 Hours	201 Stainless Steel
AY1008S	10	Mirror Polished	110V	130W	115-155°F	1-9 Hours	304 Stainless Steel
AH1202	12	Matte Black	110V	135W	115-155°F	1-9 Hours	201 Stainless Steel

Installation Instructions

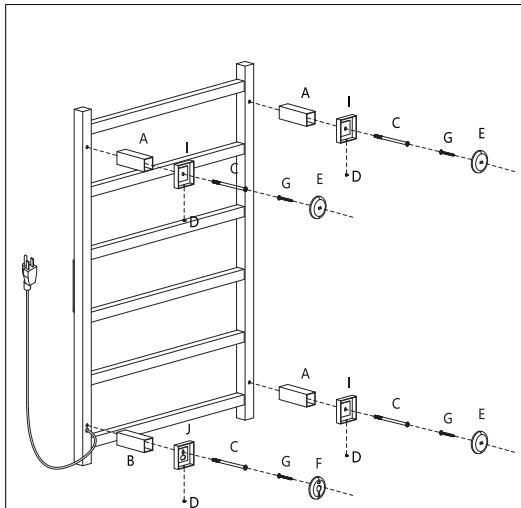

Accessories

Your package contains:



Foot Tube
A x3



Tube with
Usolt
B x1



Fixing
Screw
C x4



Grub
screw
D x4



Fixed base
E x3



Screw hole
Three-hole
fixed base
F x1
Internal wire holes



Self-tapping
screw
G x4



Wall Plug
H x4



One-hole
decorative cover
I x3



Screw hole
Two-hole
decorative cover
J x1
wire holes



Hex key
K x1

Plug-in Installation

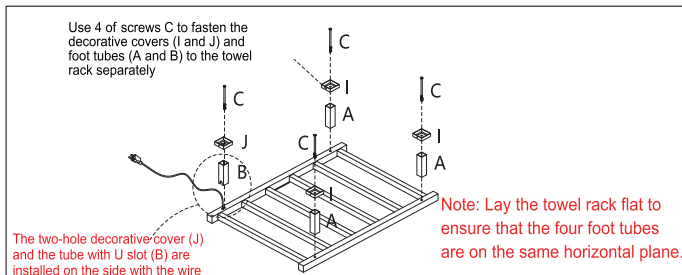

Step 1: Use 4 of screws C to fasten the decorative covers (I and J) and foot tubes (A and B) to the towel rack separately. Please note that the two-hole decorative cover (J) and the tube with U slot (B) are installed on the side with the wire.

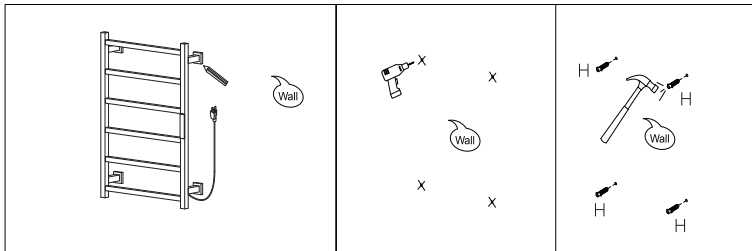

Step 2: Hold the towel rack with the installed foot tubes against the wall, ensuring it is level. Mark a circle around each base. Then mark where you will need to drill the holes through the middle of the base.

Step 3: Drill holes at the marked locations. Then insert the 4 of wall plugs H.

Installation Instructions

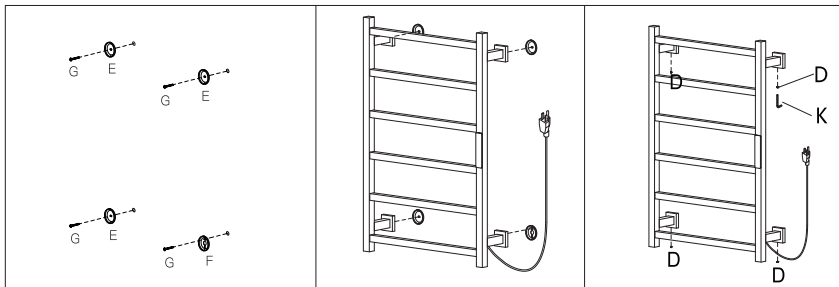

Step 4: Use 4 of screws G to fix the 3 of bases E and 1 of base F into the wall separately.

Step 5: Position the towel rack over the bases.

Step 6: Use the hex key K to tighten the 4 of grub screws D and fasten the bases to the towel rack.

Hardwired Installation



Hardwired installation requires cutting wires, so it requires a professional technician to install.

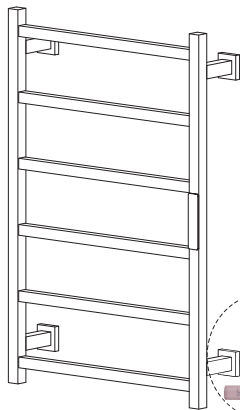

Wall

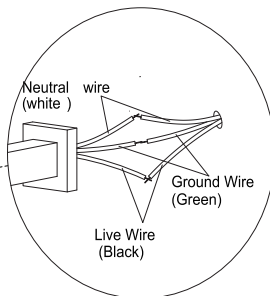

Install butt connector over bare ends of wire and crimp securely over both ends. Heat the butt connector using heat gun or similar. **Don't overheat tubing. Don't isolate flame. Distribute heat evenly over the butt connector.**

Operation Instructions



Temperature/Timer display

1-9 Hour timer function
"0H": 24-hour continuous open status

Adjust temperature
ranging from
115 to 155°F

On/off button

Questions & Answers

Questions	Answers	Solutions
Not working	There may be something wrong with the power plugs.	Check if the power socket is functioning properly and make sure the plug is connected properly.
Not hot	Aging of heating wire	Please contact us directly.
Missing accessories	The accessory box is attached to the transparent inner packaging bag. You may overlook it when unpacking the bag by pulling it all the way down, causing it to be hidden underneath the stacked packaging bag.	If you have checked the transparent bag and indeed have not received the accessory box, or if you are missing certain accessories, please contact us directly to specify what accessories you are missing, and we will send them to you immediately.
Can't be hardwired installation	Please watch our hardwired installation video and ask an electrician to assist with the installation.	Please ask an electrician to assist with the installation or contact us directly.
Slow heating	At normal room temperature, the heating time for the towel rack is approximately 5-15 minutes. If the room temperature is very low, the heating time may take longer.	Please turn on the power and adjust to the highest temperature setting, then patiently wait for 1 to 2 hours.

Important Safeguards

When using electrical appliances, basic safety precautions should always be followed, including the following:

1. READ ALL INSTRUCTIONS.

2. This unit is not intended for use by persons (including children) with reduced physical, sensory or mental capabilities, or lack of experience and knowledge, unless they have been given supervision or instruction concerning use of the appliance by a person responsible for their safety.
3. Children should be supervised to ensure that they do not play with the unit.
4. Do not operate any unit with a damaged cord or plug or after the rack malfunctions, or has been damaged in any manner. Bring it to a qualified technician for examination, repair or electrical or mechanical adjustment.
5. Do not use to dry silk fabrics.
6. Ensure that unit is securely fixed to the wall. Unit is designed for drying towels. Under no circumstances should anybody climb on or hang on unit.
7. This unit must be connected to the electrical nameplate display rated voltage on the power supply.
8. There should be at least a 48" clearing between the bottom edge of the unit and the floor.
9. To avoid a possible fire hazard, it is essential unit is mounted in accordance with guidelines stated in these instructions.

Care & Cleaning Instructions

1. For routine cleaning, simply switch off the unit, allow to cool to room temperature, wipe with a damp cloth and buff with a soft, dry cloth.
2. Under no circumstances should abrasive cleaners be used to clean the unit.
3. Do not immerse cord, plugs, or appliance in water or other liquid.

Warning

1. To avoid unnecessary risk or danger, this product must be properly grounded.
2. Any repairs must be done by a qualified technician who is deemed qualified by industry standards. When any external wire fittings are required, the unit must be disconnected from the circuit.
3. Before drilling, use an electronic detector to confirm whether there are power cables, or water pipes in the wall. If you use laser equipment to locate the borehole, please follow the below two points:
 - A. Please bring protective mirror;
 - B. Turn off the power after using the equipment.

After Sales Service

Your product is guaranteed for one year from the date of purchase. Within this period, we undertake to repair or exchange this product free of charge provided it has been installed and operated in accordance with these instructions. Should you require after sales service you should contact our customer services at sdtproservice@outlook.com. Please do not return a faulty product to us in the first instance as this may result in loss or damage and delay in providing you with a satisfactory service. Thanks!

Add: 1383 S Cucamonga Ave., Ontario, CA 91761

Tel: 323 831 2020

Email: sdtproservice@outlook.com

If the number you called is busy or not answered, please do not hesitate to contact us via email. We will reply you back within 10 hours.

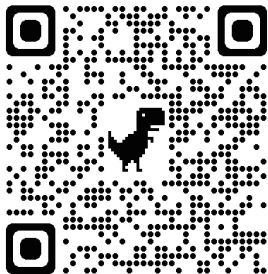

Installation Video
QR Code

1. Open the built-in camera app on your phone.
 2. Point the camera at the QR code.
 3. Tap the banner that appears on your phone.
 4. You will open our YouTube installation video.
- Tip: You can't scan a QR code in portrait and video mode.



Installation Video
QR Code

Add: 1383 S Cucamonga Ave., Ontario, CA 91761

Tel: 323 831 2020

Email: sdtproservice@outlook.com

If the number you called is busy or not answered, please do not hesitate to contact us via email. We will reply you back within 10 hours.