

LOUNGE CHAIR



If you need to return the goods, please keep all the packaging materials and return it in the original packaging.
Si vous devez retourner la marchandise, veuillez conserver tous les matériaux d'emballage et le retourner dans l'emballage d'origine.
Si necesita devolver los productos, conserve todos los materiales de embalaje y devuélvalos en el embalaje original.
如需退货请保留好所有包装材料，并按原包装包好退回。

PARTS / PIÈCES / PARTES / 部件清单

X1

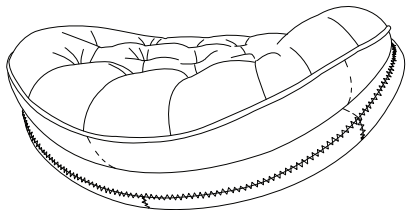

(P1)

X1

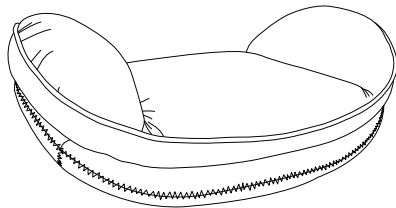

(P2)

X1

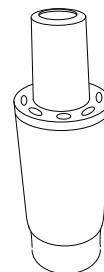

(P3)

X1

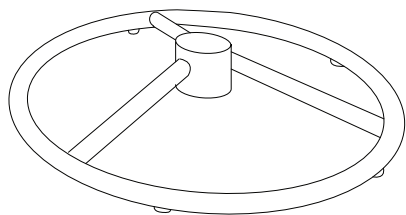

(P4)

HARDWARE / MATÉRIEL / HARDWARE / 配件清单

M8*100mm X3



(A)

8*22*1.5mm X3

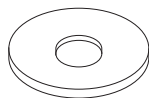

(B)

M8 X3

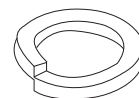

(C)

M8 X3

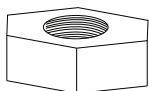

(D)

X1



(E)

ASSEMBLY INSTRUCTIONS

INSTRUCTIONS DE MONTAGE

INSTRUCCIONES DE MONTAJE

安装说明

STEP 1

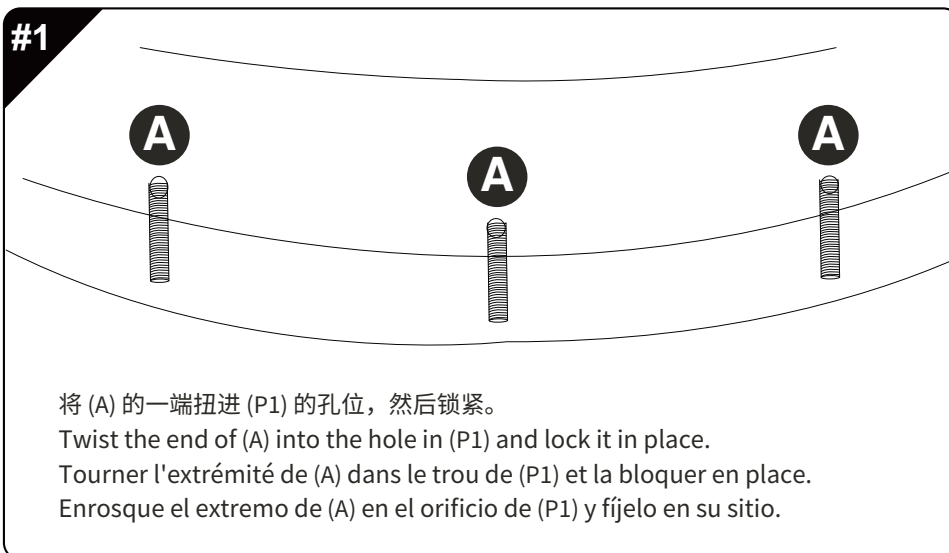
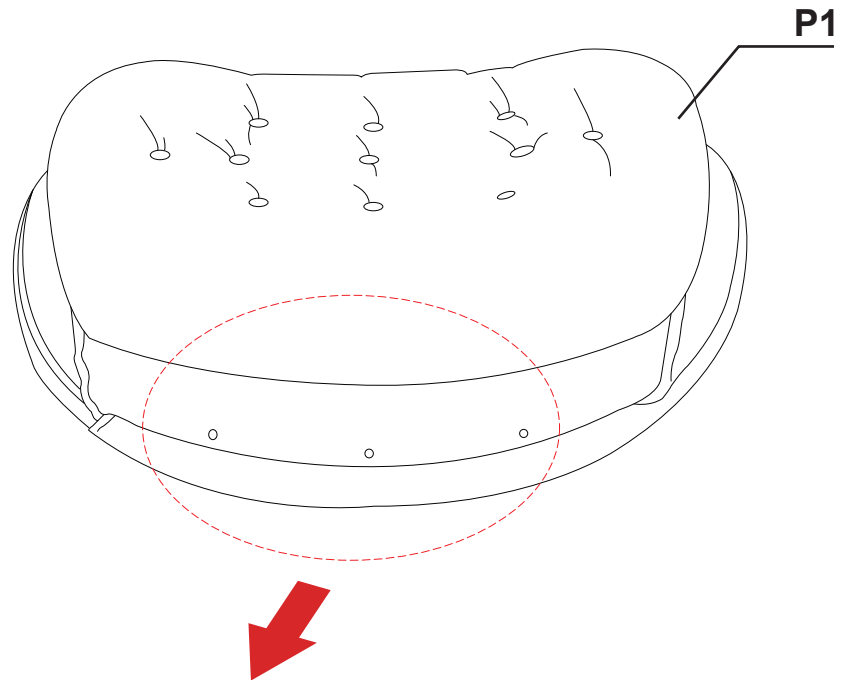
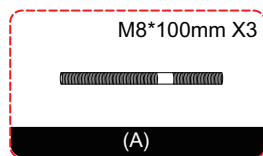
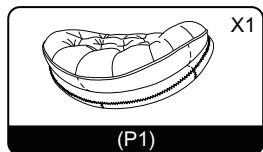

STEP 2

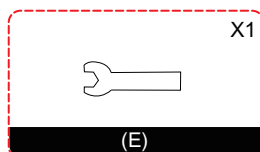
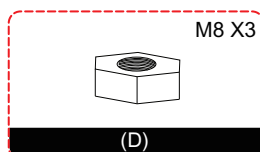
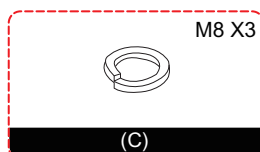
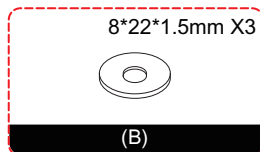
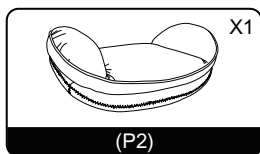

#1

拉开 (P2) 的拉链, 将 (A) 插入 (P2) 孔中, 用 (B), (C) 和 (D) 固定, 用 (G) 锁紧。
Unzip (P2), insert (A) into (P2) holes, secure with (B), (C) and (D), and lock with (G).
Dézippez (P2), insérez (A) dans les (P2) trous, fixez avec (B), (C) et (D), et verrouillez avec (G).
Abra la cremallera (P2), introduzca (A) en los (P2) orificios, fíjela con (B), (C) y (D), y ciérrela con (G).

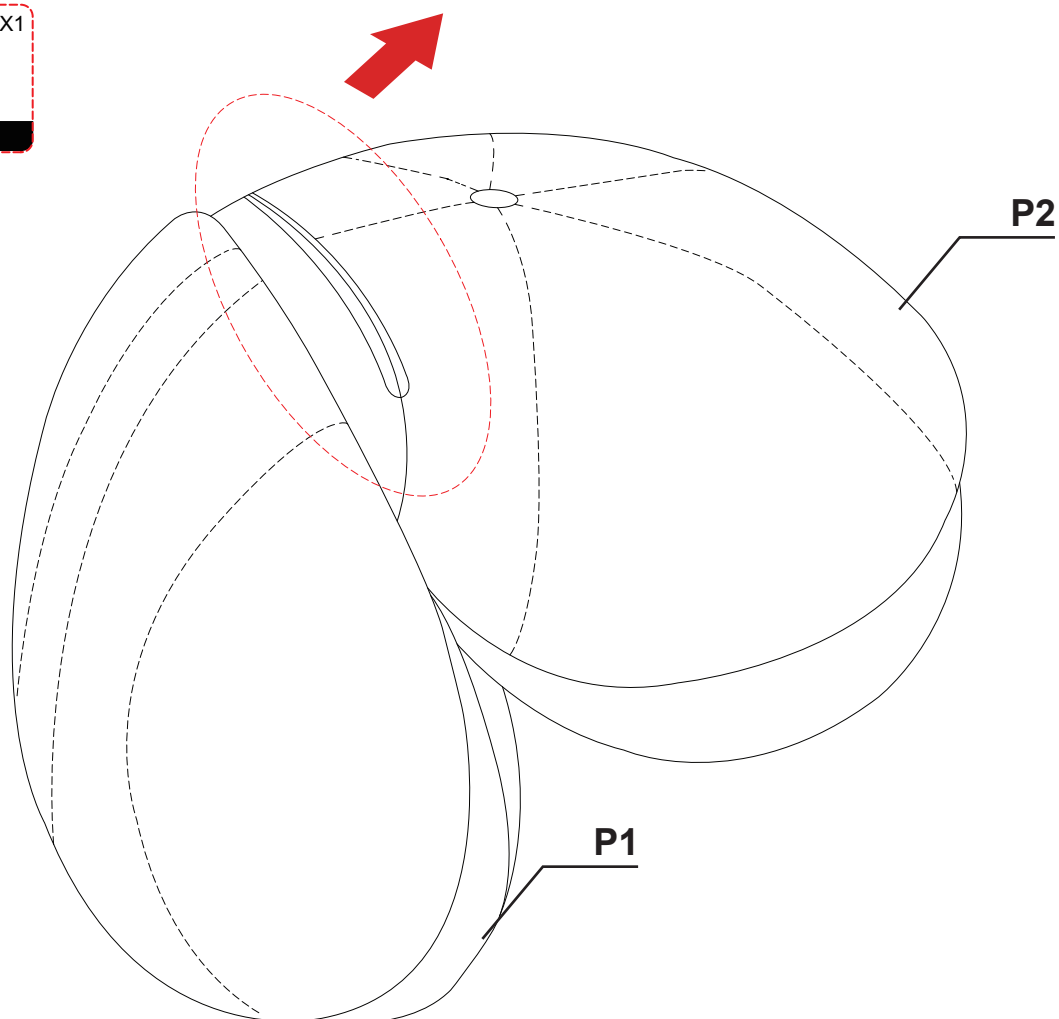

STEP 3

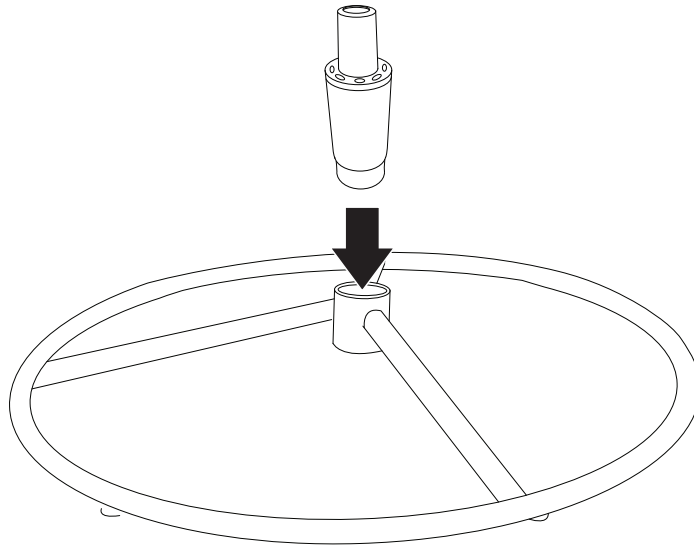
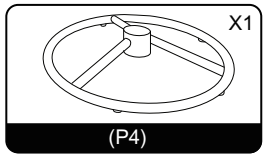
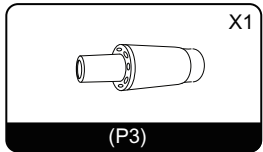

STEP 4

