

ASSEMBLY INSTRUCTIONS

MODULAR SOFA

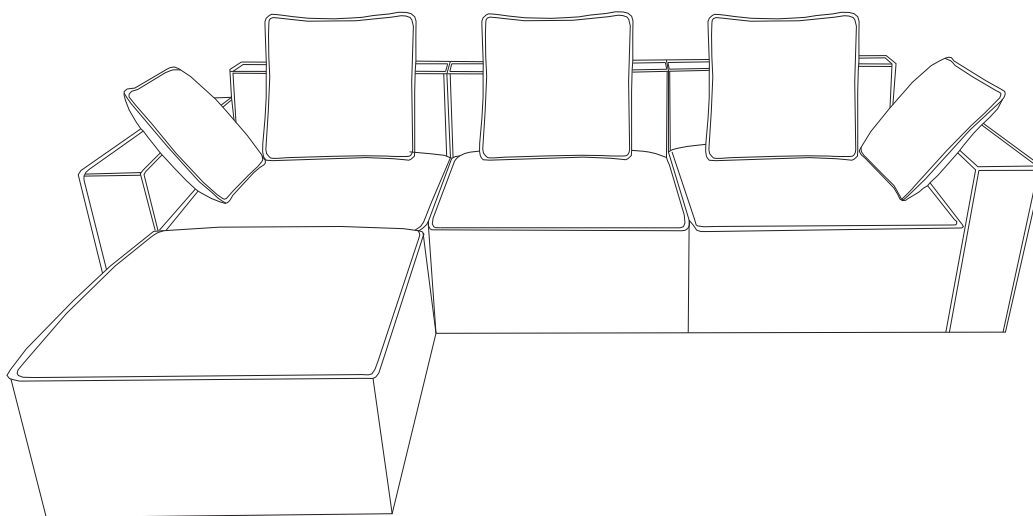

TIME



2 OF PEOPLE



DIFFICULTY

NOTICE

Instruction Booklet - Important Safety Information

Thank you for choosing our product. Please review this booklet carefully for essential safety information and keep it for future reference.

- Upon receiving the product, ***ensure all parts are present and intact*** before proceeding with installation. Follow the entire installation instructions provided.
- During installation, exercise caution and refrain from immediately tightening screws. Secure all screws to 80% before final tightening.
- The item may arrive in multiple packages depending on the number of seats purchased, with an additional package included. If packages are not received simultaneously, contact us for tracking numbers of remaining boxes.
- Note: Cushions are ***compressed*** and cannot be recompressed once opened. Returns are accepted only for items in their ***original, unopened condition***.



Before installation, please check that the parts are all included !

Multiple Configurations

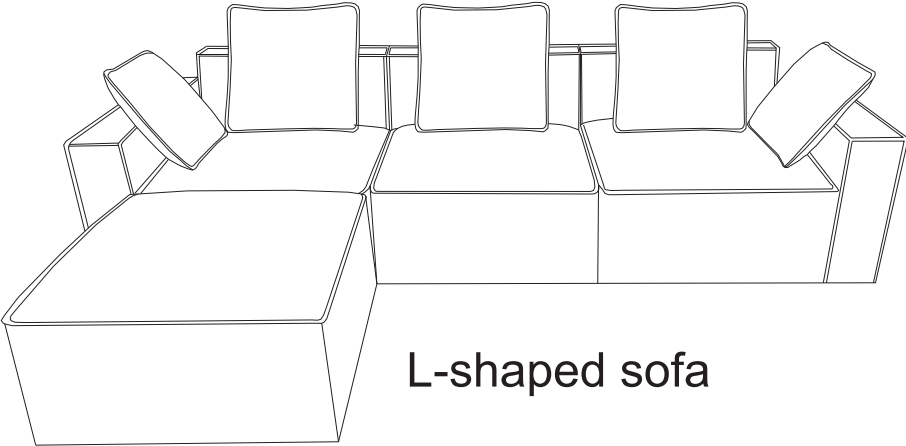



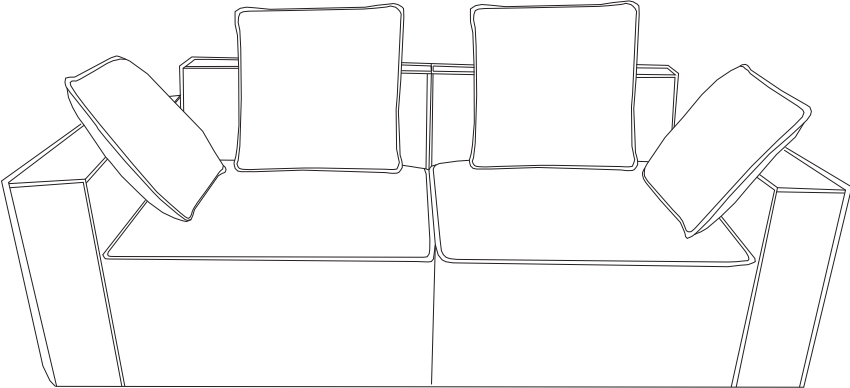



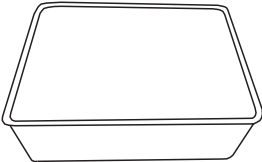
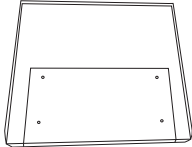
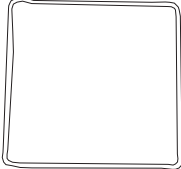

L-shaped sofa



Loveseat

The installation method of the L-shaped sofa below.

Carton A		
Materials ▶		
 A*2	 C*2	 D*2
 E*4	 M*4	 G*8
 L*8	 M8*35mm O*24	 N*24
 R*1		

Carton B

Materials ▾



A*1

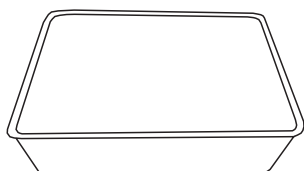

B*1

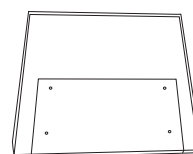

C*1

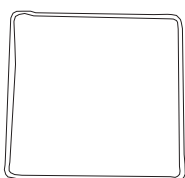

D*1



E*2



M*2



G*8



L*8

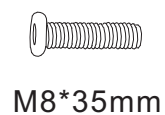

M8*35mm

O*12



N*12



R*1

Carton C

Materials ▾

Left

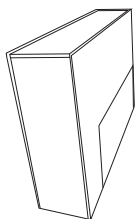

H*1

Right

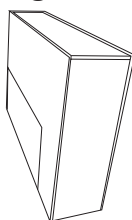

I*1



P*2

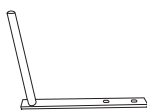

F*4

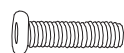

M8*35mm

O*8



N*8



R*1

Installation Steps

Materials ▶

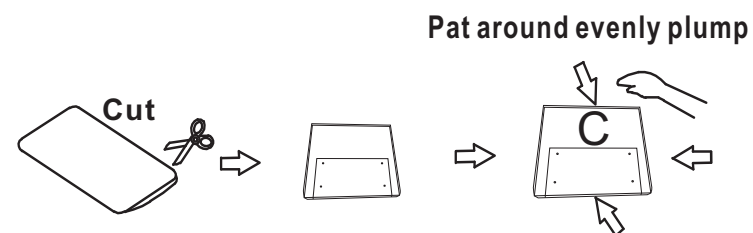
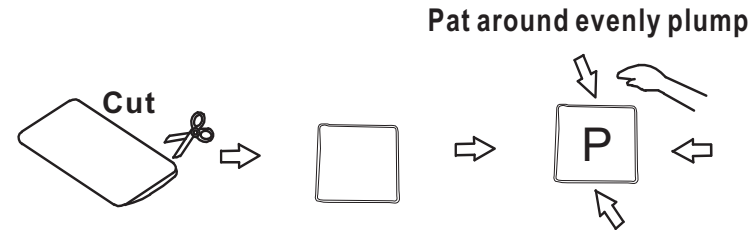
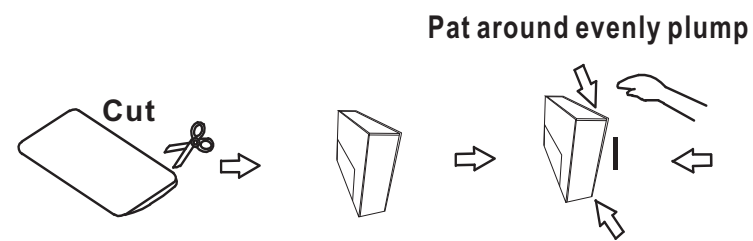
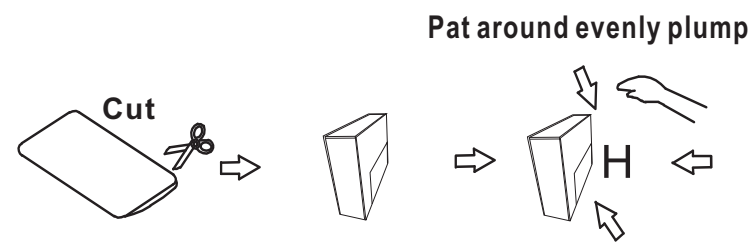
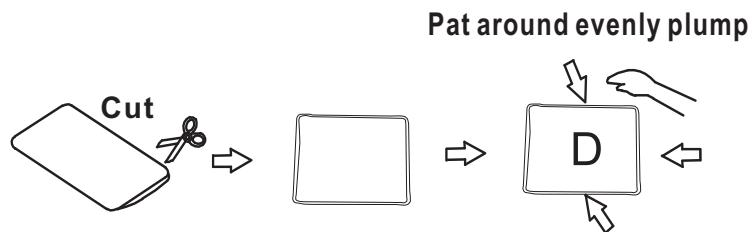
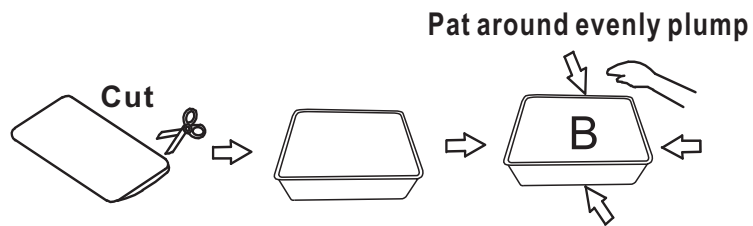
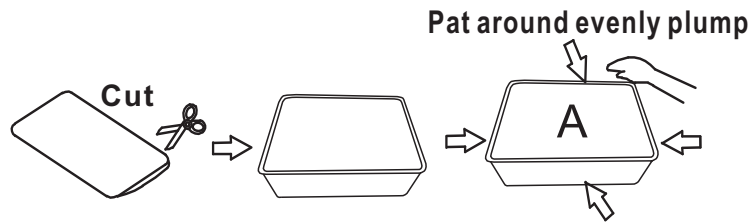

STEP 1

Install feet on each sofa base

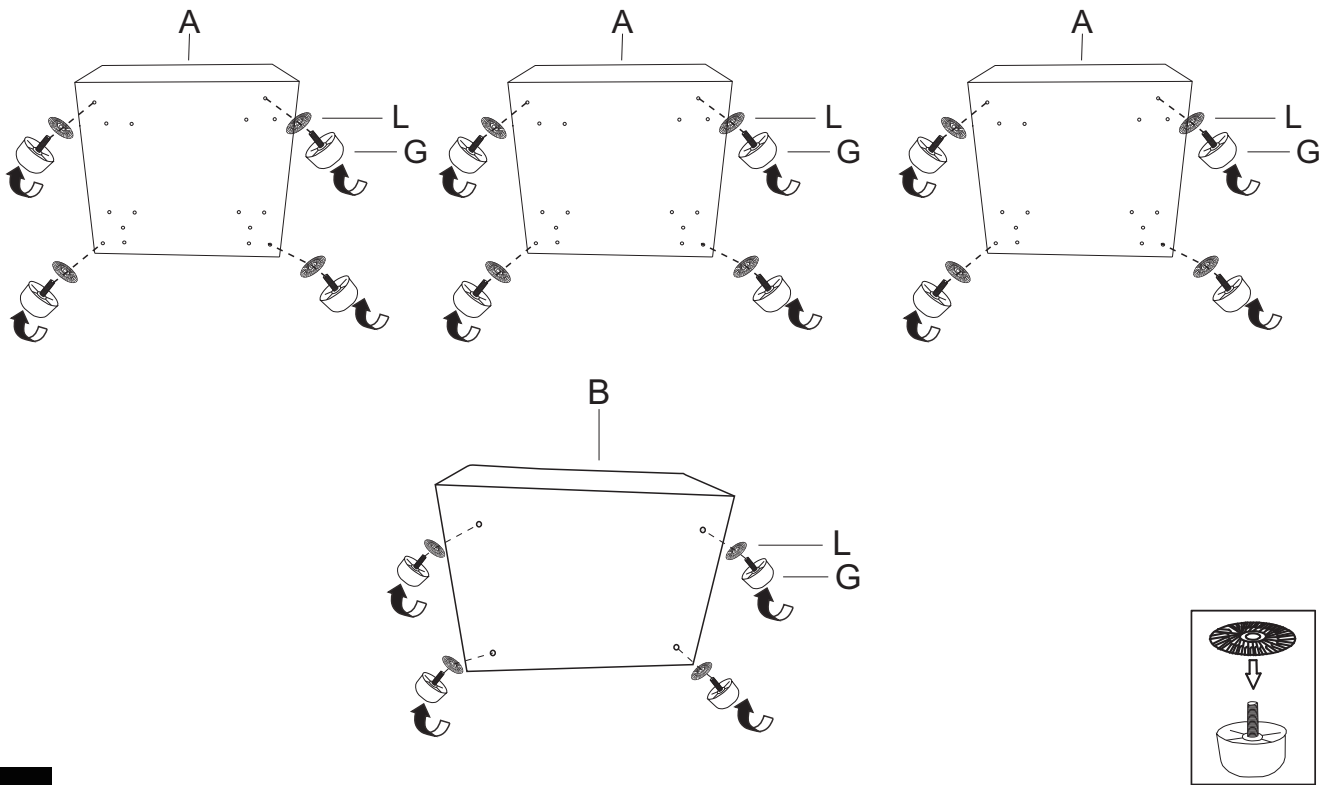

STEP 2

Attach the L-shaped iron frame to the backrest

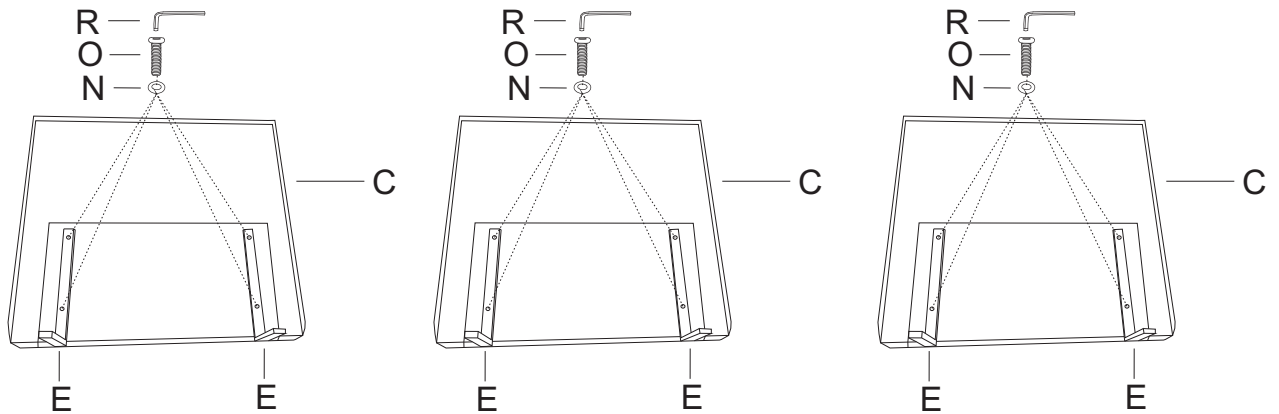

STEP 3

Assemble the backrest and 4 accessories

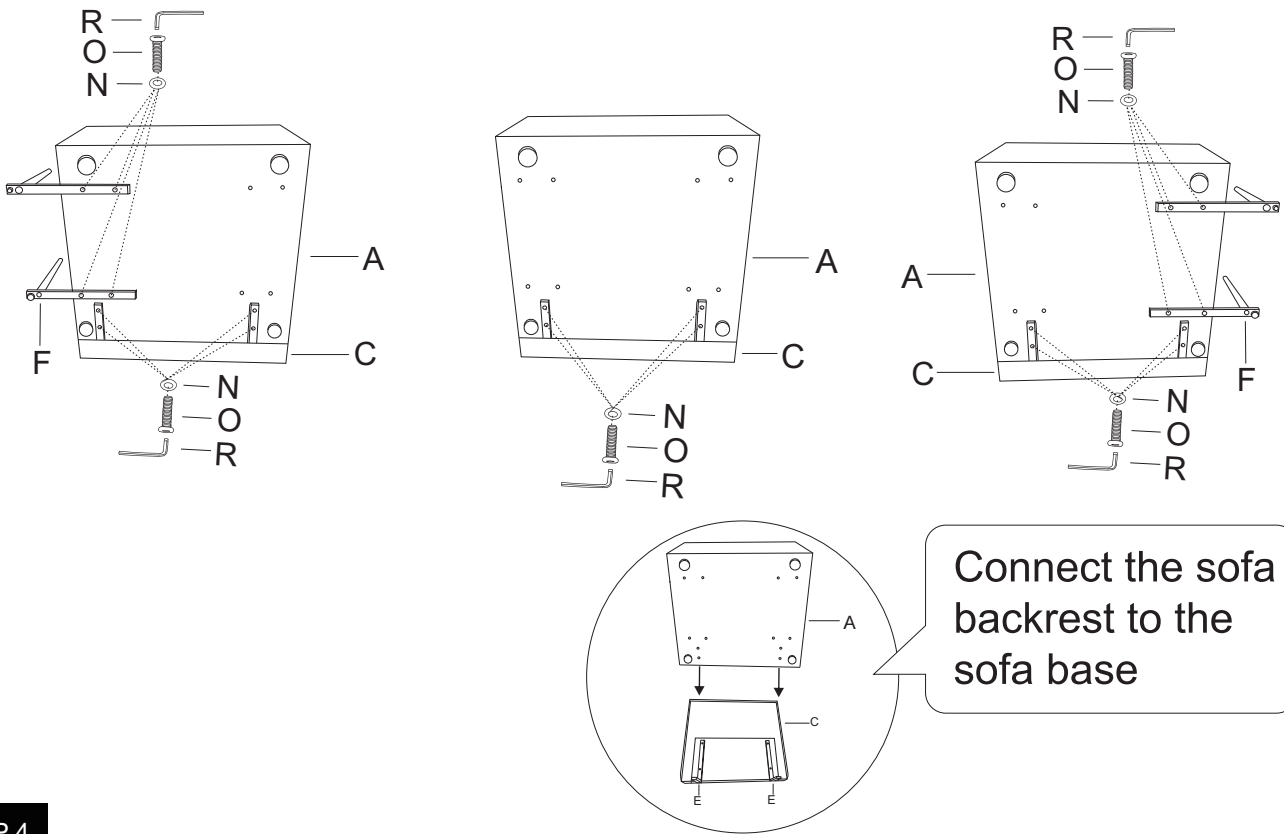

STEP 4

Connect the seated frame

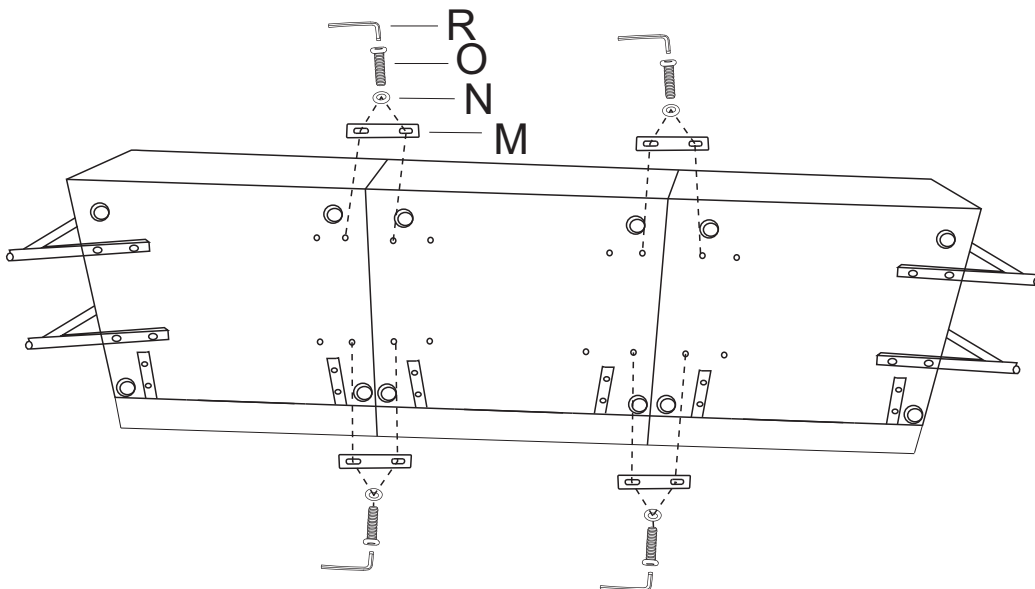

STEP 5

Assemble the armrests

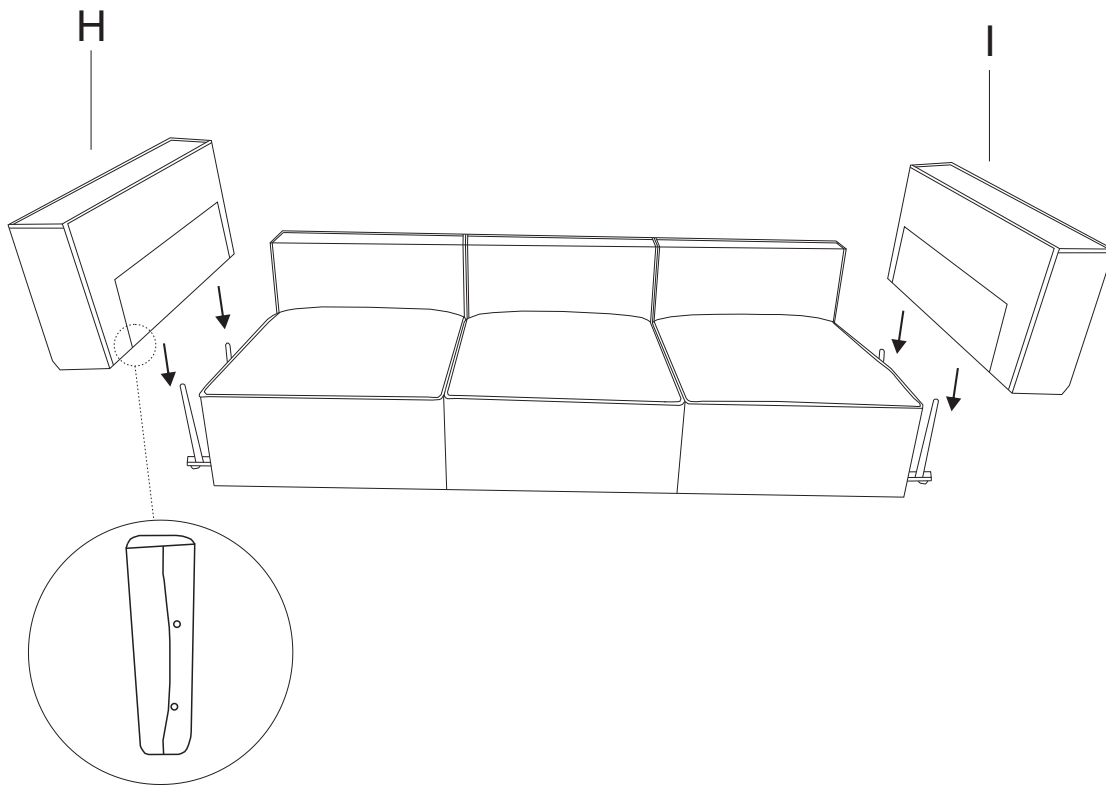

STEP 6

Put the back cushions, armrest pillow, and footrest in the corresponding position

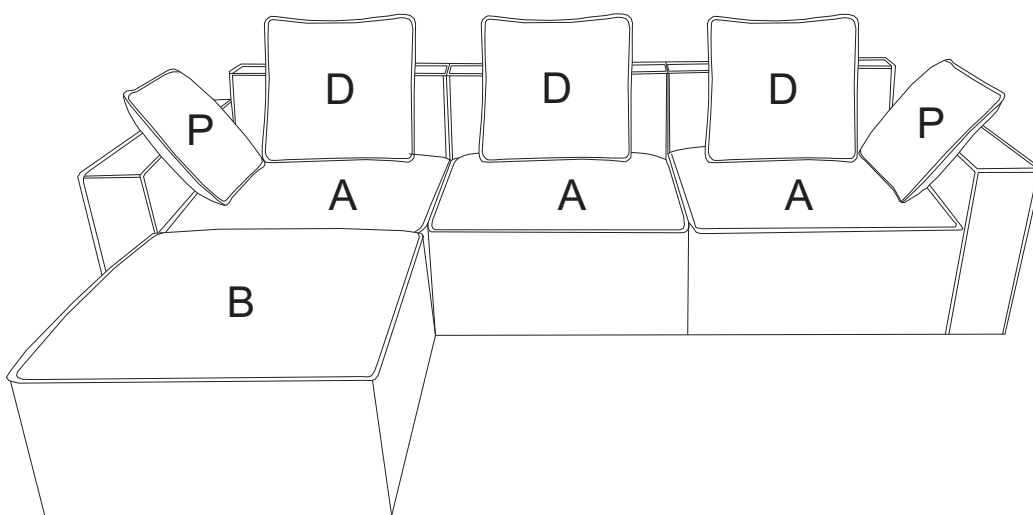

STEP 7

ASSEMBLY INSTRUCTIONS

Loveseat

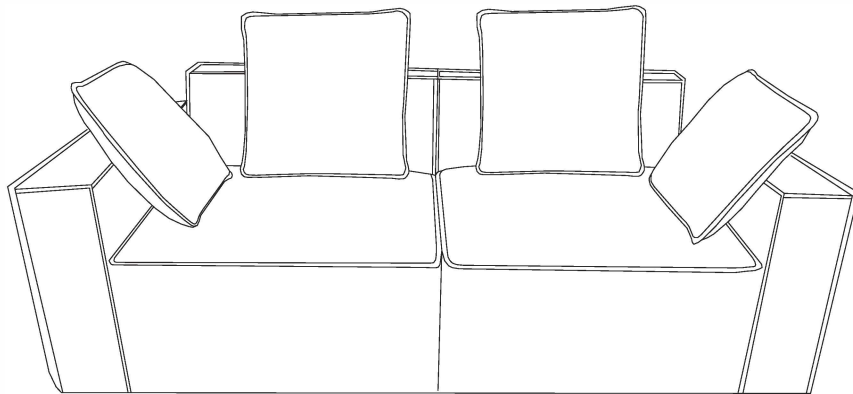

TIME



2 OF PEOPLE



DIFFICULTY

The installation method of the L-shaped sofa below.

Carton A

Materials ▾

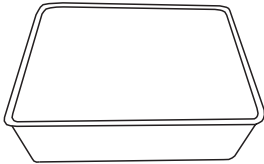

A*2

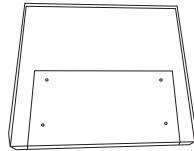

C*2

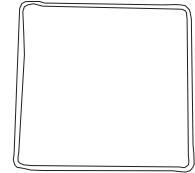

D*2



E*4

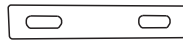

M*4



G*8



L*8



O*24



N*24



R*1

Carton C

Materials ▾

Left

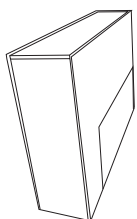

H*1

Right

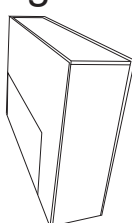

I*1



P*2



F*4

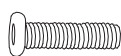

M8*35mm

O*8



N*8



R*1

Installation Steps

Materials ▶

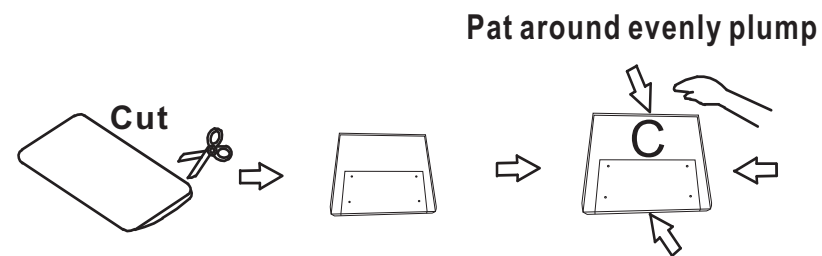
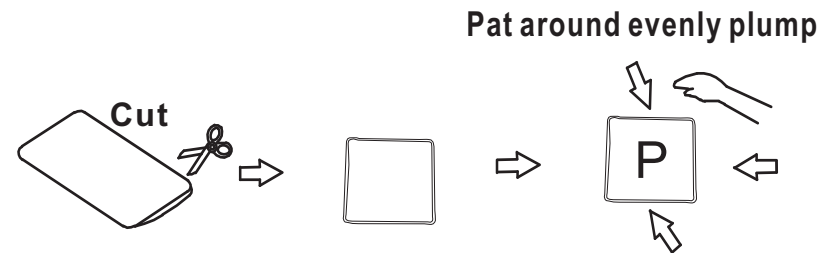
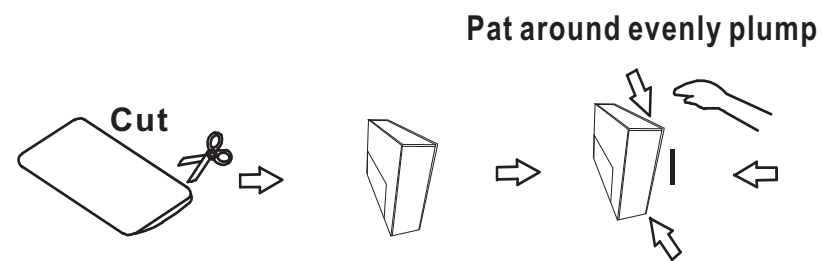
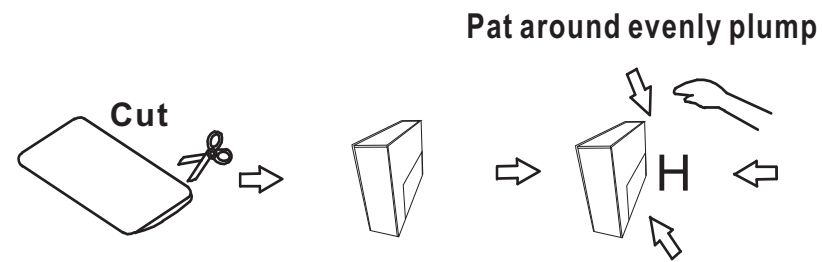
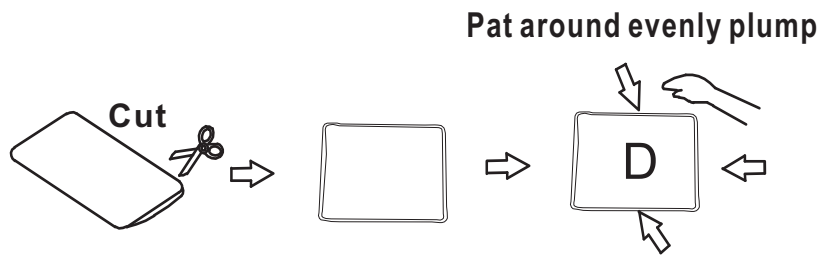
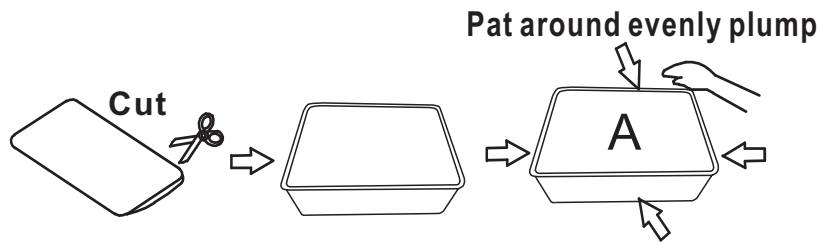

Install feet on each sofa base

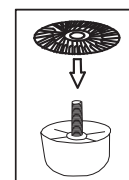
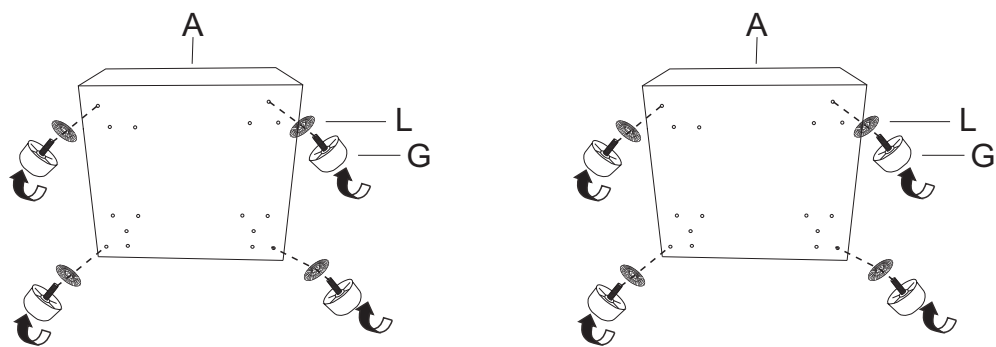

STEP 2

Attach the L-shaped iron frame to the backrest

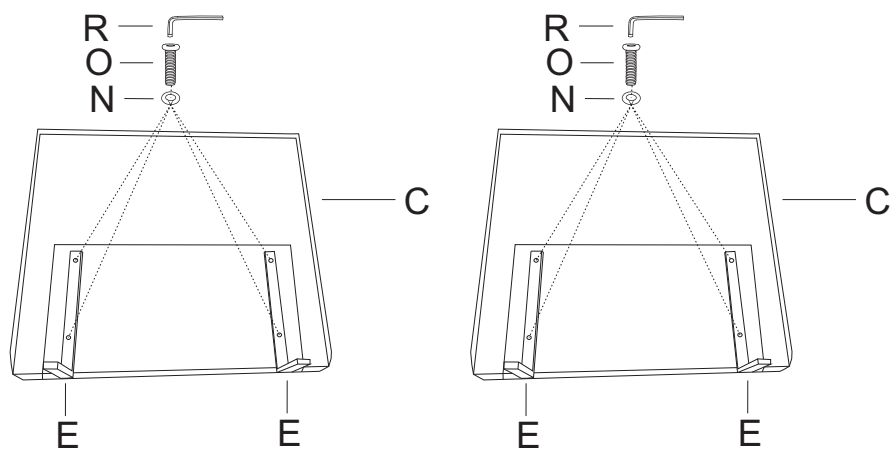

STEP 3

Assemble the backrest and 4 accessories

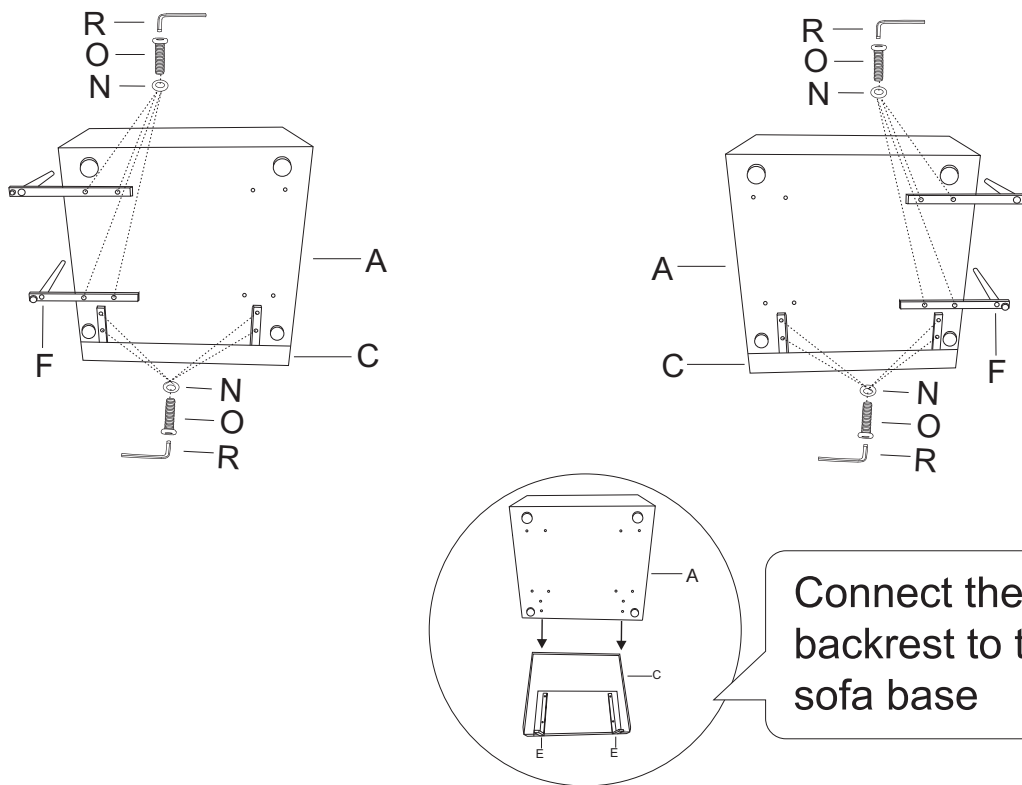

STEP 4

Connect the seated frame

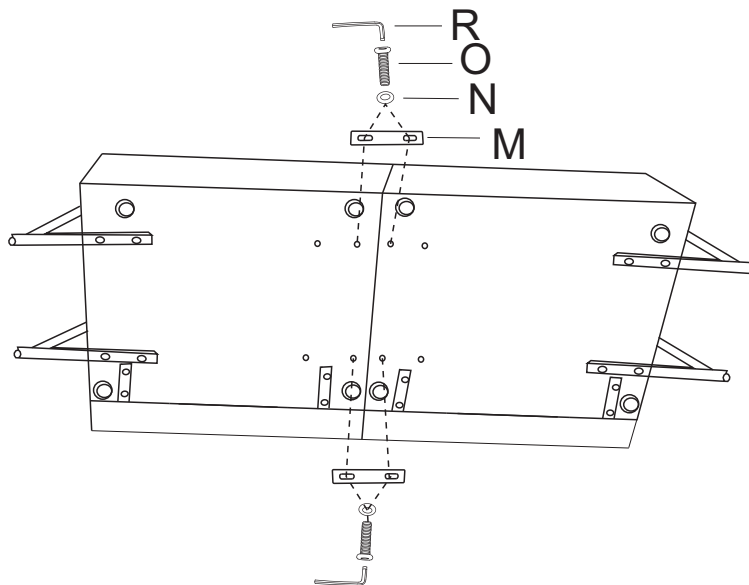

STEP 5

Assemble the armrests

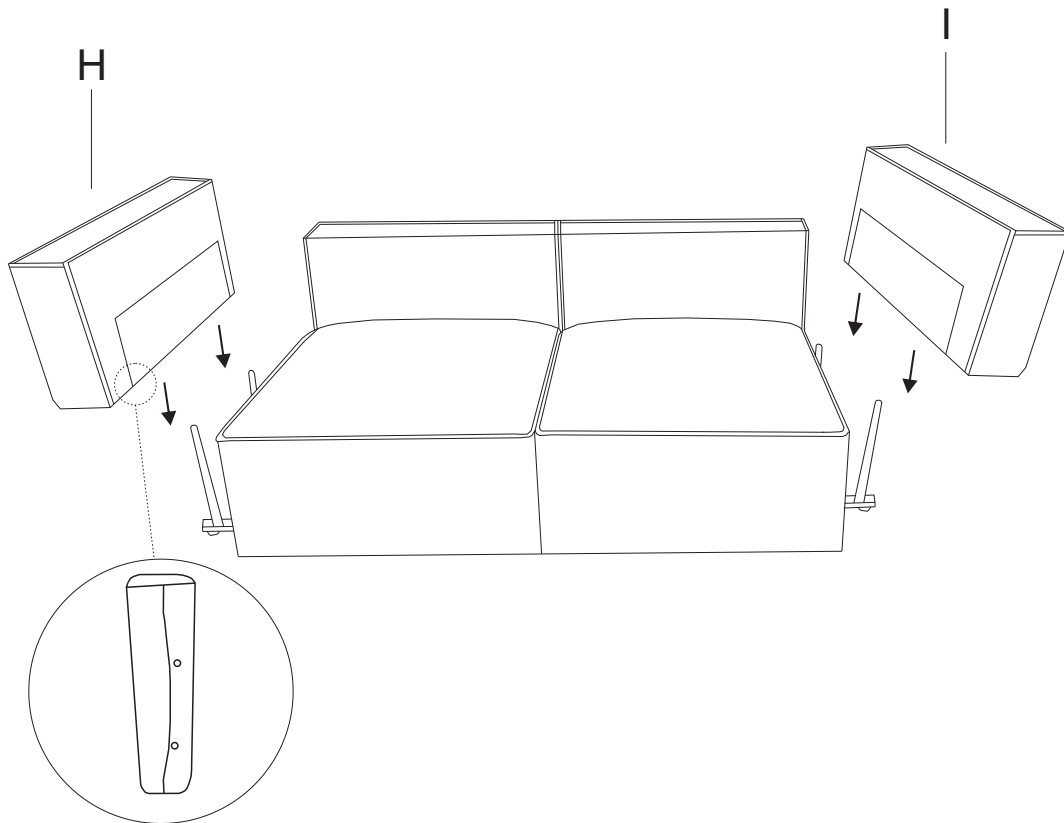

STEP 6

Place the back cushions and armrest pillow in the appropriate position

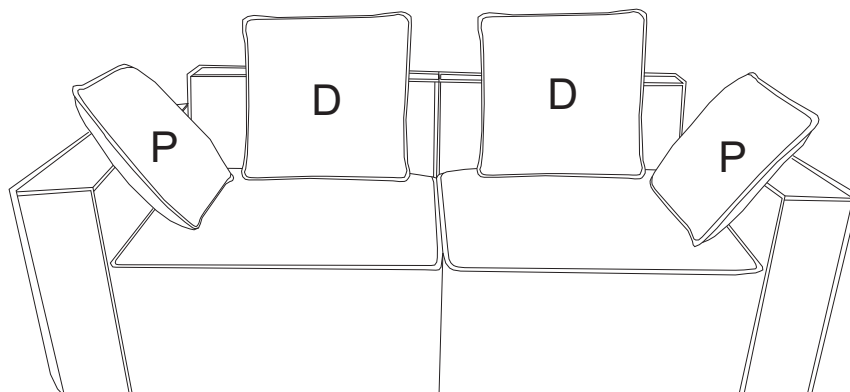

STEP 7

Frequently Asked Questions

We understand that receiving damaged or defective products can be disappointing, and we're here to assist you every step of the way. Here's how to address common concerns and initiate a damage claim:

1.What should I do if my shipment is damaged or products received are defective?

We're genuinely sorry to hear about any inconvenience caused. Please reach out to us promptly, and our team will prioritize resolving the matter swiftly and effectively. To file a damage claim, follow these steps:

A. Retain the original box in case a return is required.

B. Take photos of the damaged box, the damaged part of the item, tracking number, and return label on the box to help us process a replacement or refund.

2.Can I return the product if I'm not satisfied?

While we uphold stringent quality standards and collaborate with experienced manufacturers, we acknowledge that dissatisfaction may arise. If you're still unsatisfied, you can initiate a return within 30 days of receiving the product. Simply message us with your reasons for return, and we'll facilitate the process.