

# Product Warranty Information

Thank you for choosing a Hi-Line product! We strive to bring the best home and garden decor products for our customer from across the world. Our exclusive designs and systematic approach to make your home a wonderland for you! In the event that we have not achieved our usual standard of excellence, we will repair or replace, at our discretion, within the warranty period. A valid proof of purchase, with the purchase date clearly indicated, must be provided. Photos of defective merchandise will also be required to help distinguish the actual cause of the defect. Please read below for a detailed description of warranty coverage.

## Procedure/Service

Should a warranty/claim be needed, you should contact the retailer from whom you purchased the product. If that is not an option, you can contact Hi-Line Gift Ltd at [www.hilinegift.com](http://www.hilinegift.com). When contacting Hi-Line Gift Ltd, you must be prepared to show PO#, PO Date, and buyer name, proof of purchase, provide photographs and any other information needed to validate your claim. This may be necessary to distinguish between a partial or complete replacement of a defective product.

The warranty does not cover any items with multiple parts; the warranty will ONLY cover the individual component of the unit/item that may be defective. Replacement parts can be made available to a consumer through the original selling party, or an approved parts retailer. If this is not an option, contact our customer service department. Item is covered under one year limited warranty from the date of purchase. If your purchase was after our 30-day grace period, payment information will be requested for shipping charges.

## Return/Damage Claim Instructions

- ⚠ **Do not discard the box / original packaging.**  
The item must be returned in the original box, otherwise your return will not be accepted.
- ⚠ **Take a photo of the box markings.**  
In case a part is needed for replacement, a photo of the markings (text) on the box is required to identify the item number and ensure you receive the correct parts.
- ⚠ **Take a photo of the damaged part if (applicable).**  
A photo of the damage is always required to file a claim and get your replacement of refund processed quickly, Please make sure you have the box even if it is damaged.
- ⚠ **Send us an email with the images required.**  
Email us directly from marketplace where your item was purchased with the attached images and a description of your claim.

## Not Covered Under Warranty

- The limited warranty will NOT cover cases of damages due to
1. Inadequate care and/or neglect
  2. Environmental and/or natural elements
  3. Improper Installation/use and/or Maintenance

*This warranty also does not cover any additional charges or installation, removal, disposal and/or shipping costs or consequential damage associated with any warranty claim.*

## Owner's Manual

Item # 78684-BK / 78684-CM



HI-LINE GIFT LTD.



**Have Questions or Issues?  
Need help with assembly?  
Contact us via email or phone.**

(For faster assistance, please include PO#, PO Date, and Buyer Name in your email.)

Email: [support@hilinegift.com](mailto:support@hilinegift.com)

Website: [www.hilinegift.com](http://www.hilinegift.com)

Call: 1-800-868-9176 (US) 905-564-2815 (Canada)

## Before you start

- Please read this instruction before use of this product.
- Separate and count all parts and hardware. If any parts are missing do not attempt to use the product until they have been obtained and correctly installed.
- Read through each step carefully and follow the proper order.
- Place the product on a level surface, near to the area where it is likely to be placed in use.
- Keep pets, babies and children away from all small parts and components of this product as they potentially pose a serious choking hazard.
- Please keep this instruction manual for future reference.

### TOOLS REQUIRED



### HARDWARE

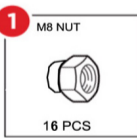

### PARTS

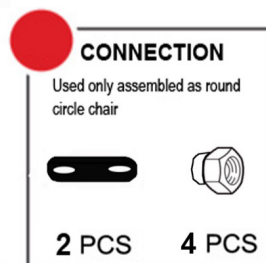
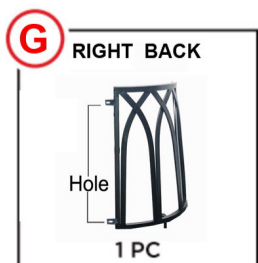
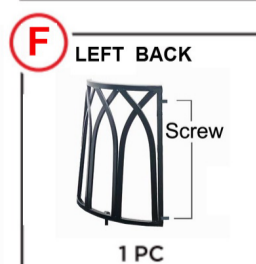
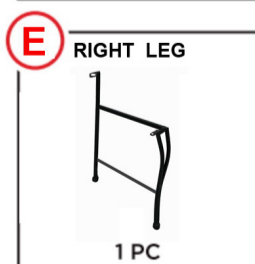
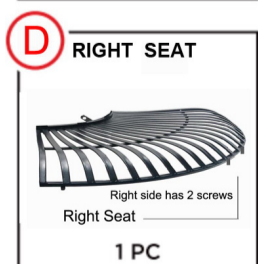
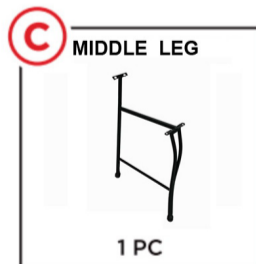
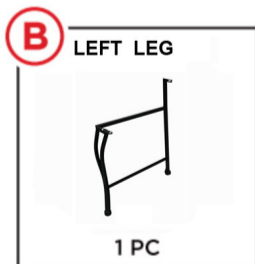

## Product assembly

### NOTE:

Carefully remove all parts from box and remove protective wrapping. In order to let you assemble more easy, please only match caps on screws firstly, let caps loosely, make sure don't tighten them before match all parts.

- 1 One person find out Part A, and hold it like below picture show. Another person assemble Part B and Part C onto Part A with screws by hand.
- 2 Assemble Part D onto Part C with screws by hand.
- 3 Assemble Part E onto Part D with screws by hand.
- 4 Assemble Part F onto Part G with screws by hand.
- 5 Assemble Part FG onto Part AD with screws by hand like show.
- 6 Tighten all screws by wrench, make sure that assembly is secure.

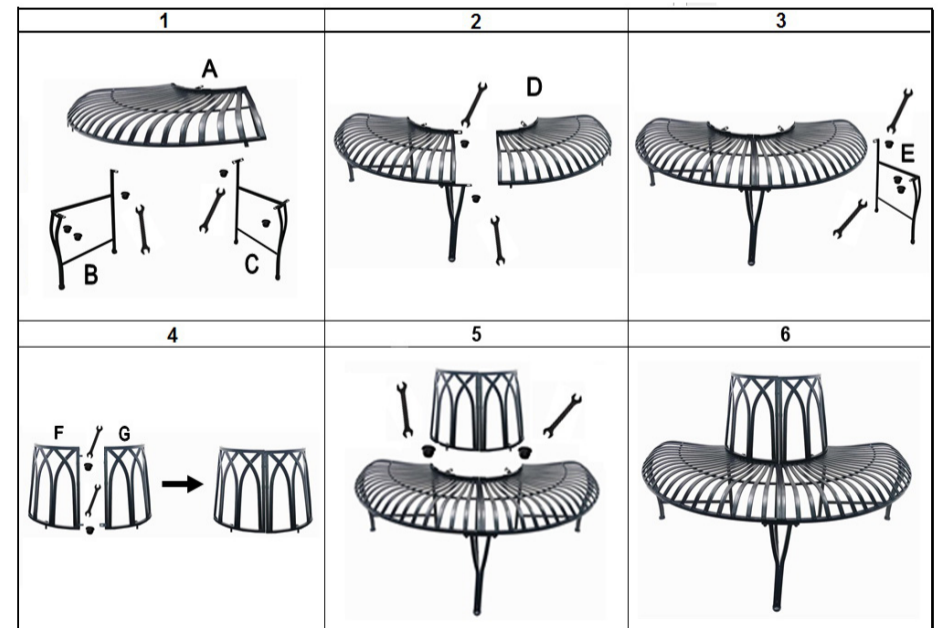

- 7 If you have two half-chairs, and want to assemble them in one round circle, you can refer the below picture and connect them with attached CONNECTION hardware

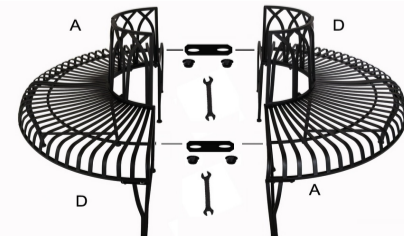

HI-LINE GIFT LTD.



Scan for assembly video