

















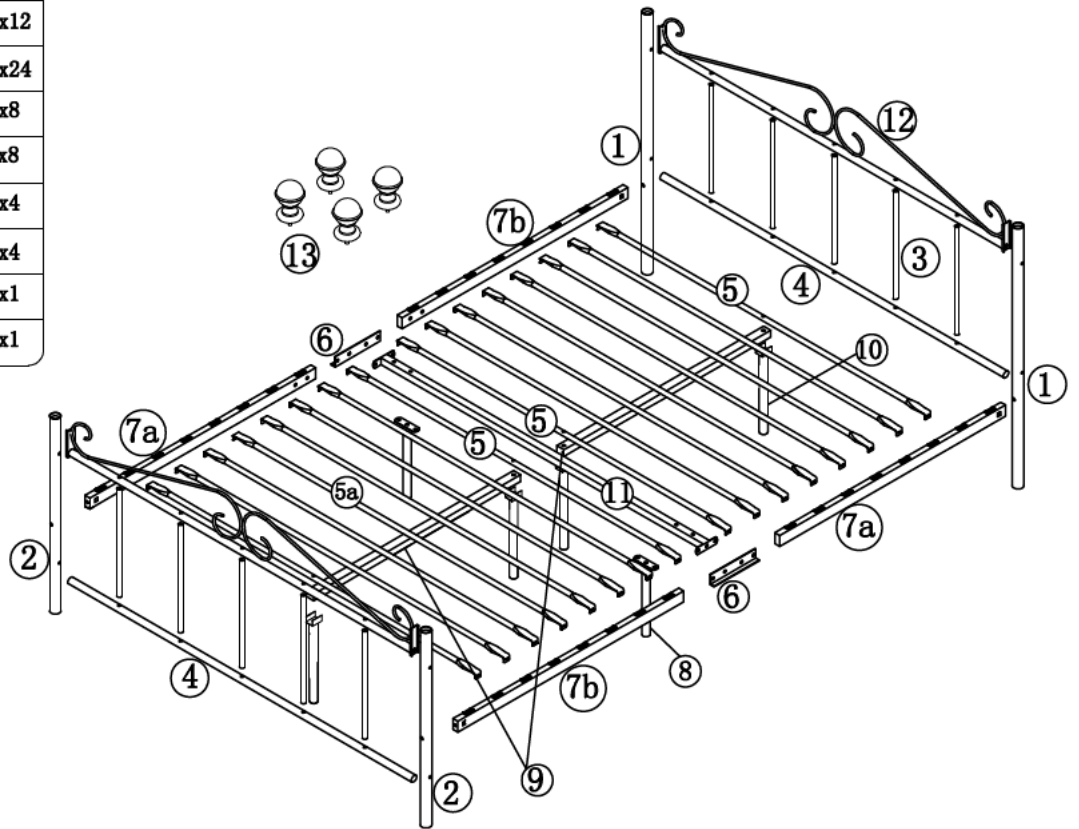
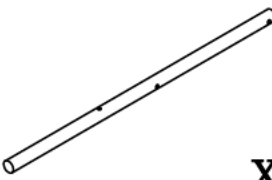

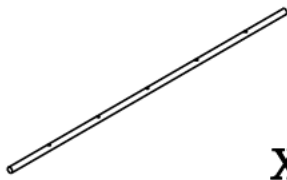
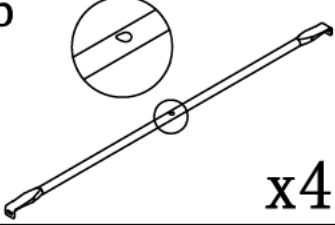
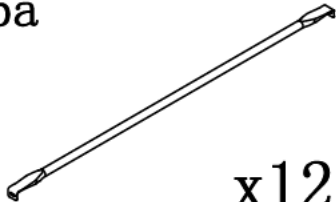
A		M8x70mm	x4
B		M6x60mm	x12
C		M6x35mm	x24
D		M6x15mm	x8
E		M6	x8
F			x4
G		M6	x4
H			x1
I			x1

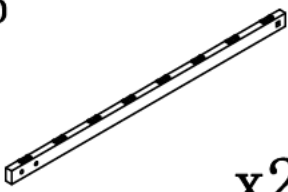

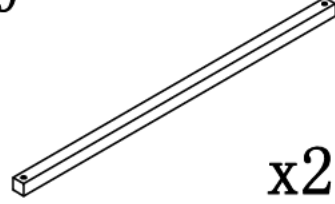
1  x2	2  x2	3  x10	4  x2
5  x4	5a  x12	6  x2	7a  x2
7b  x2	8  x2	9  x2	10  x4
11  x1	12  x2	13  x4	

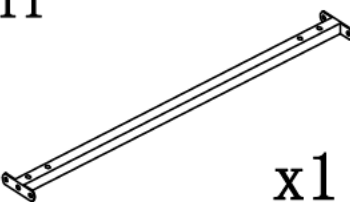
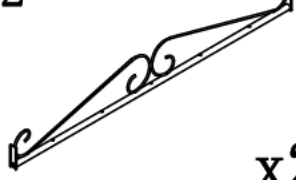
STEP 1

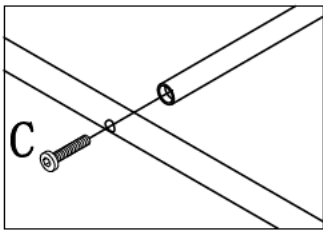
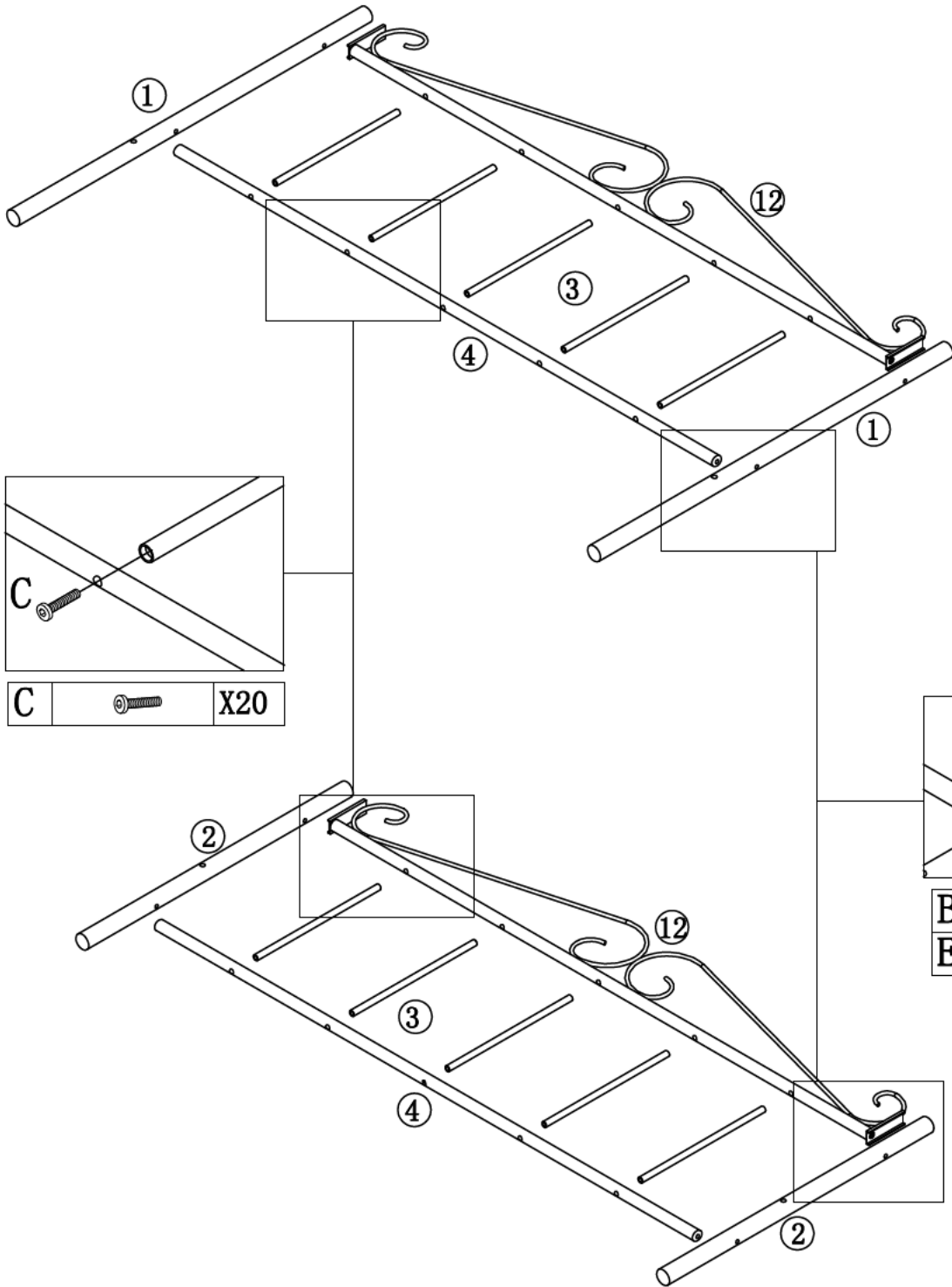

C		X20
---	--	-----

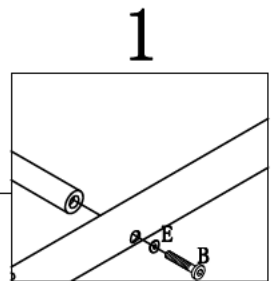

B		X8
E		X8

STEP 2

Please separate the parts 7a and 7b before beginning the assembly.

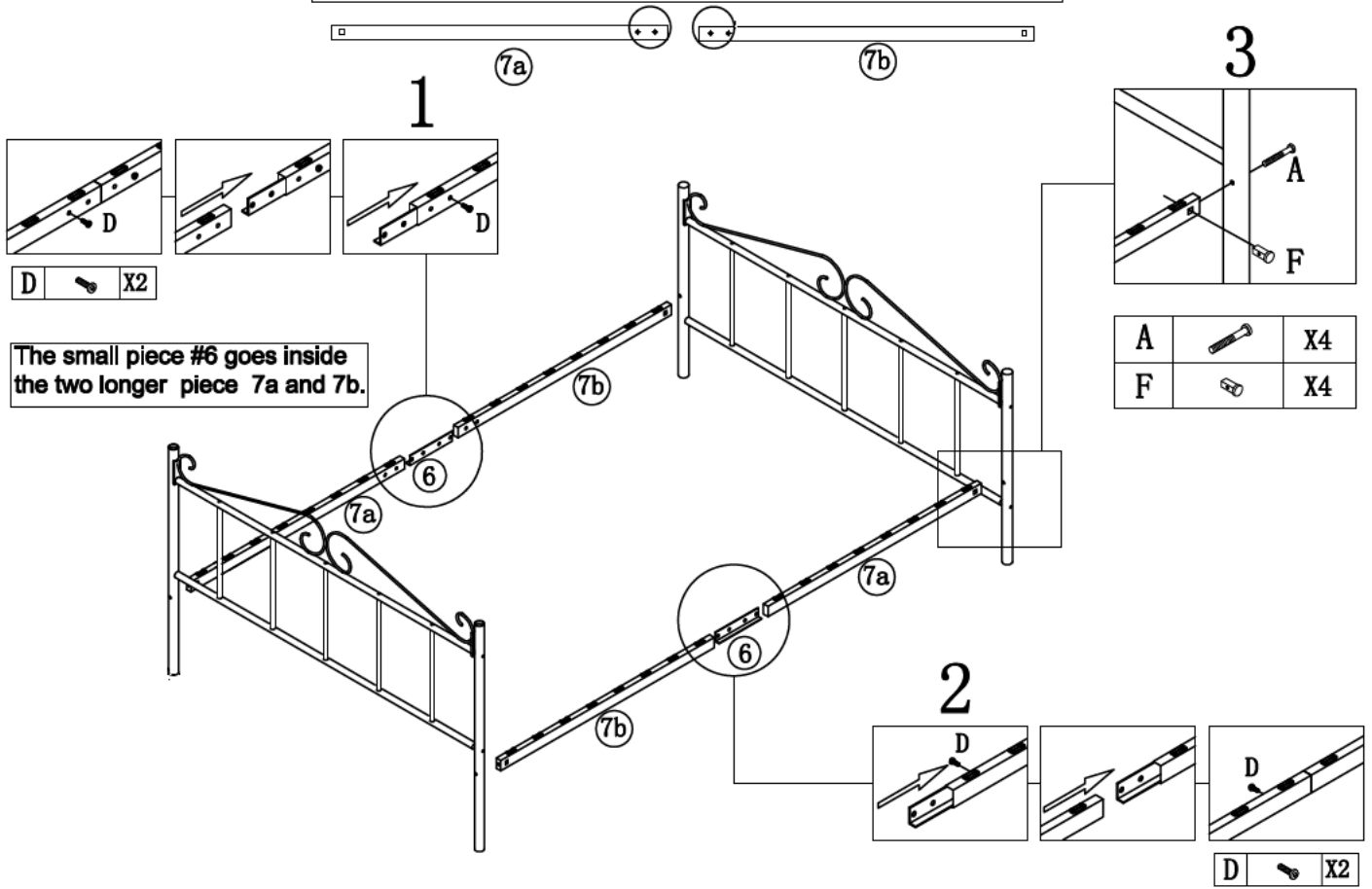

STEP 3

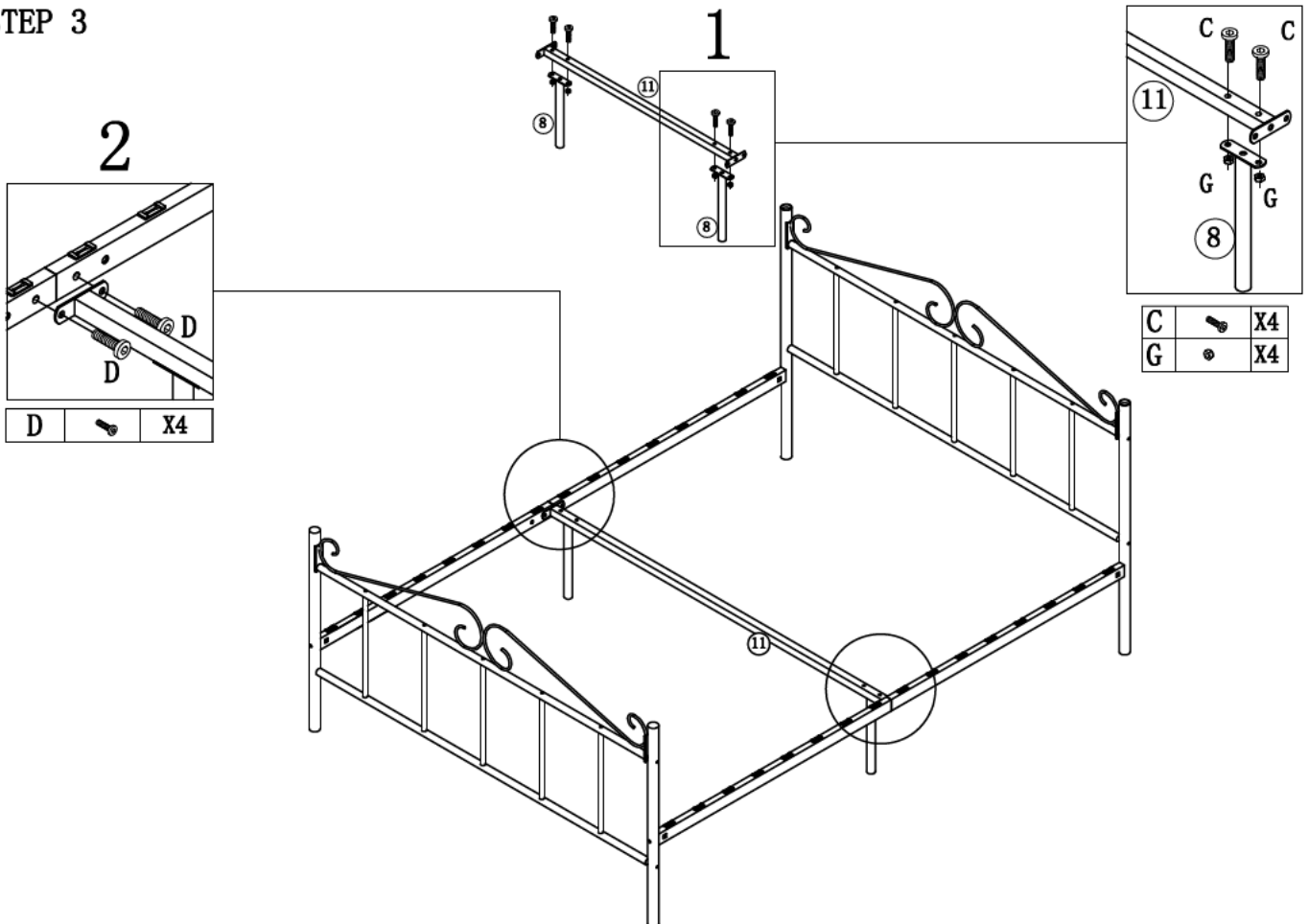

STEP 4

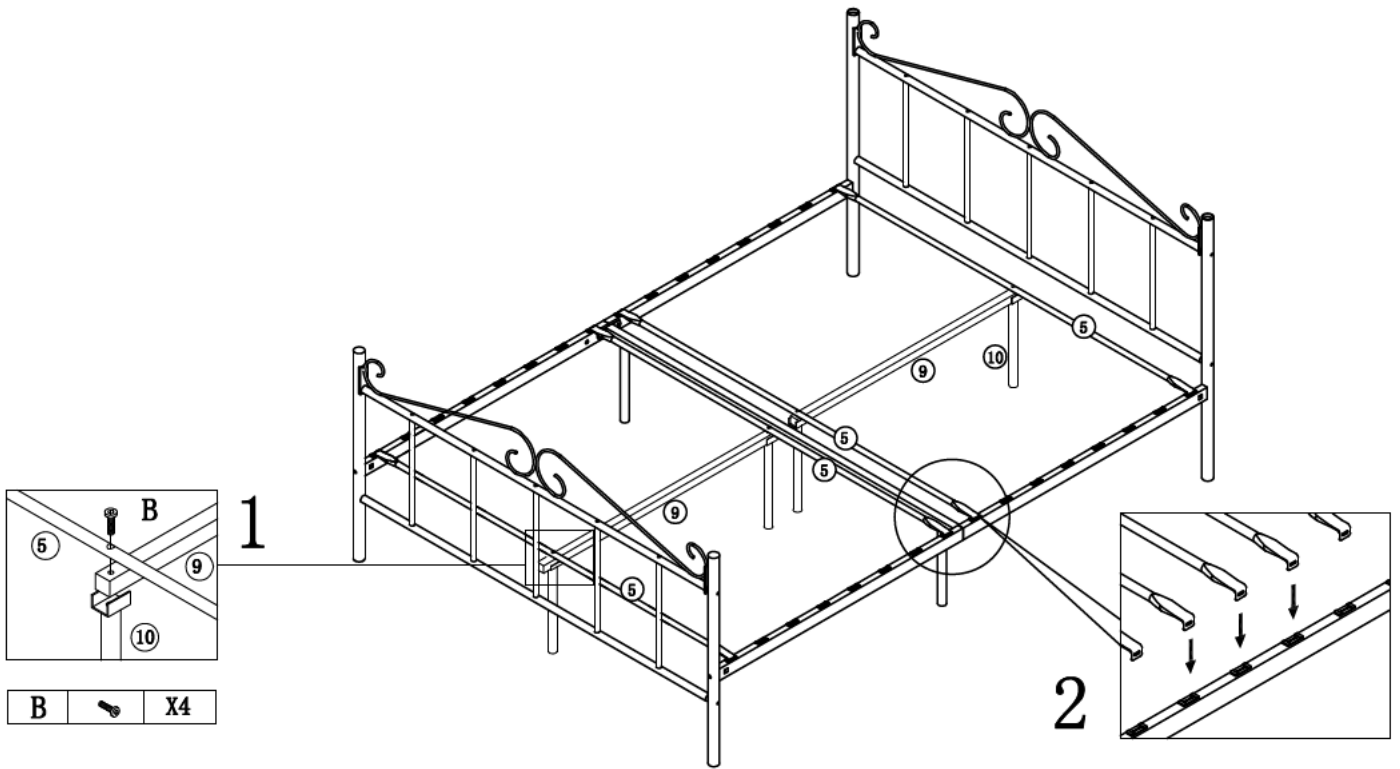

STEP 5

