

Assembly instructions for the chair, including warnings, time, and person requirements.

**Warning 1:** Do not use a power drill. Use an Allen key (shown in a circle) to tighten the backrest.

**Warning 2:** Do not use a screwdriver to adjust the seat. Use a block (shown in a circle) to support the seat during assembly.

**Time:** 15'

**Person:** 1

A

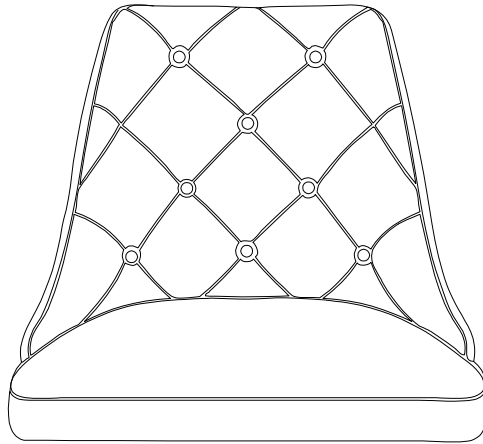

B x 2

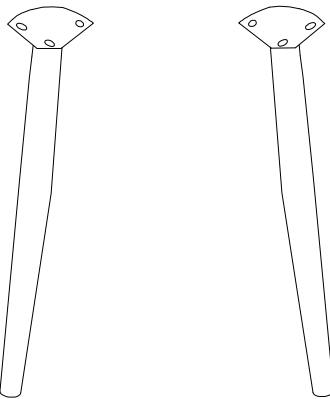

C x 2

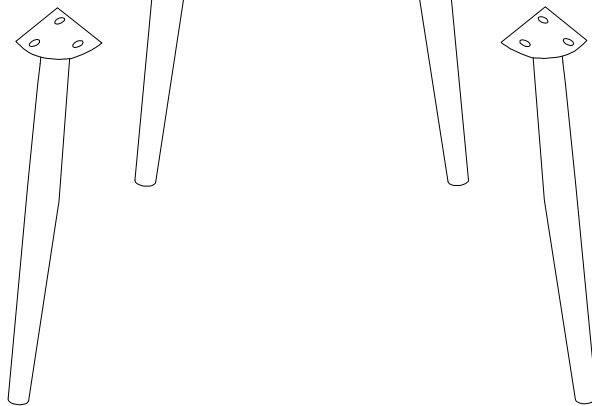

A

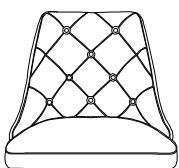

x 1

B



x 2

C



x 2

D

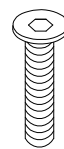

M6  
x  
20

x 12

E

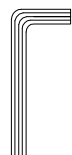

x 1

1

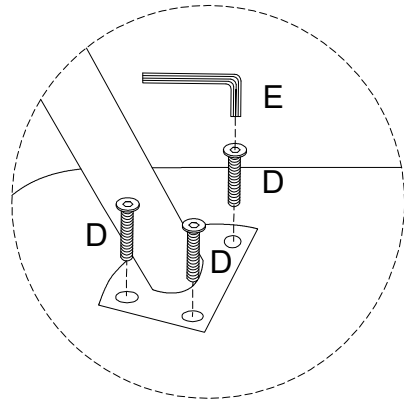
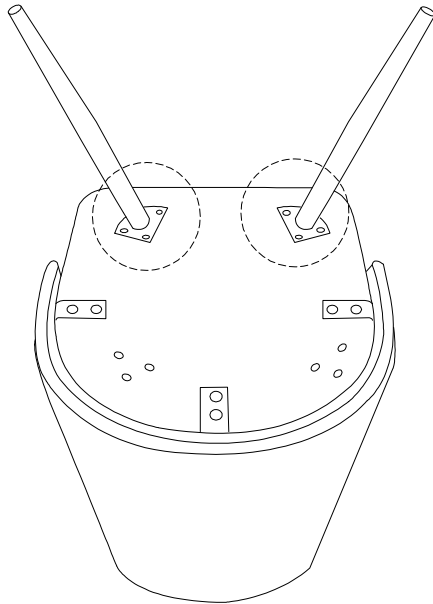
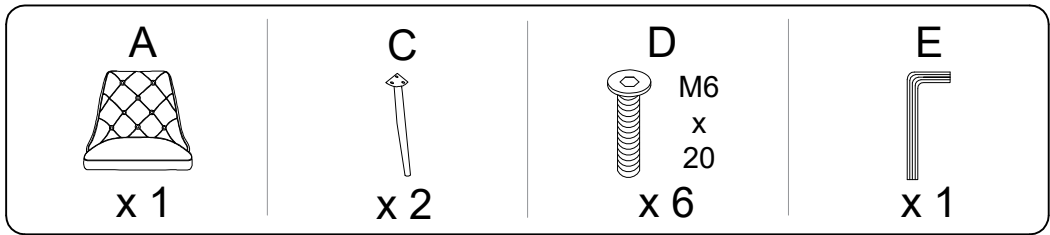

2

