

## Assembly Guide

### Tip!

DO check for all the components and screws listed in this guide before putting things together. If any part is missing, contact us

### Return Policy

Your satisfaction is our top priority. If our product fails to satisfy you, please let us know how we can make things right for you. Our trained customer care team can handle most concerns and assist you with any questions you may have. Simply shoot them a message with your order number and question. To be eligible for a full-refund return, the item must be in pristine condition, in the original packaging, with all of the shipped components intact and not yet assembled, and with the item's unique proof of purchase.

### Trouble shooting:

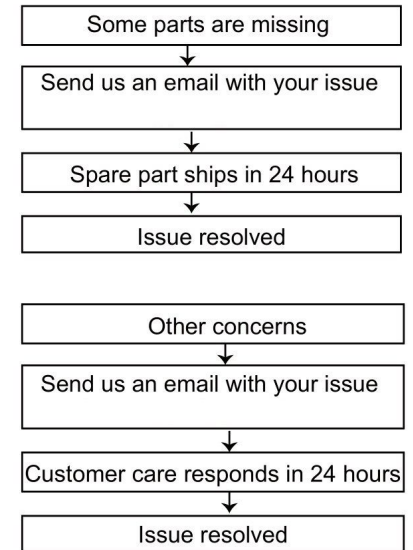



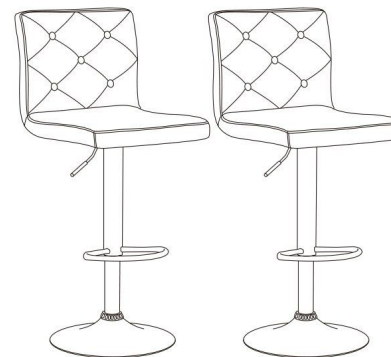



We run our own manufacturer, so rest assured about the quality consistency.

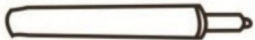

Item Description: Barstool  
Dimension: 43\*48\*114cm

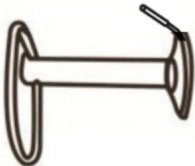
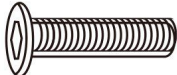
# Components

<b>A</b>		2
<b>B</b>		2
<b>C</b>		2
<b>D</b>		2
<b>E</b>		2
<b>F</b>		8
<b>G</b>		2

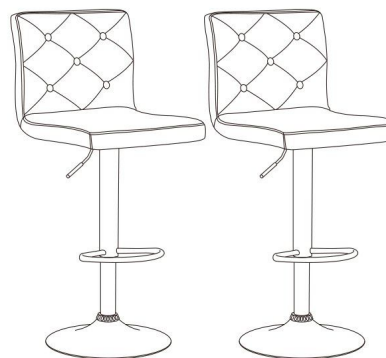

Barstool

Dimension: 43\*48\*114cm

## Step 4

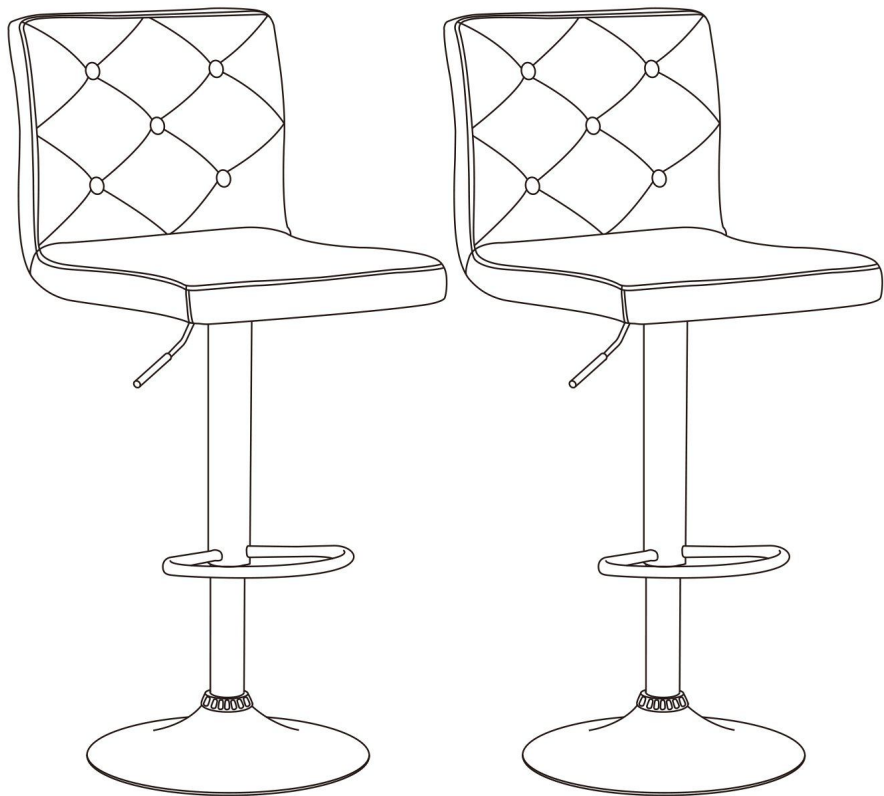

## Step 1

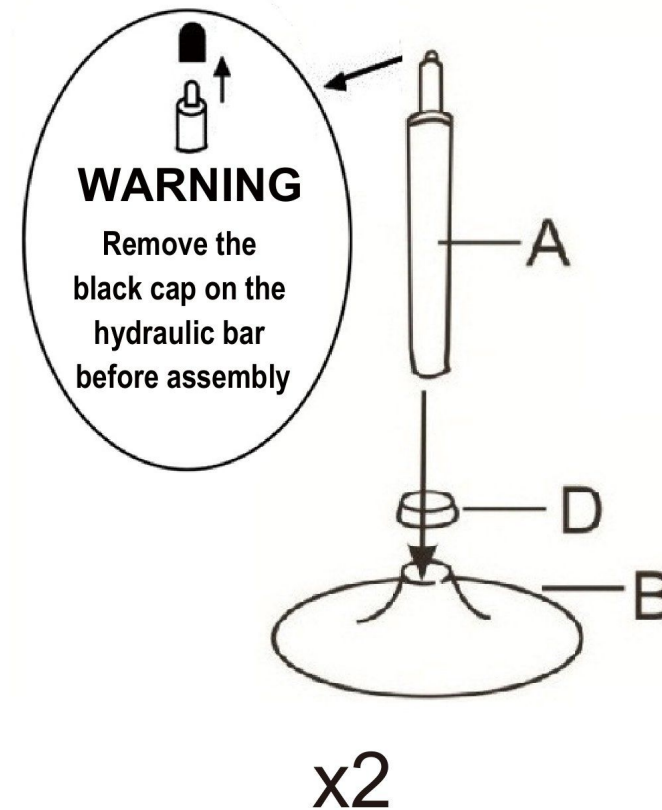

1. Remove the cap on hydraulic bar(A); Find base (B); Install decoration ring (D) and hydraulic bar(A) on base(B).

## Step 2

 Fx8

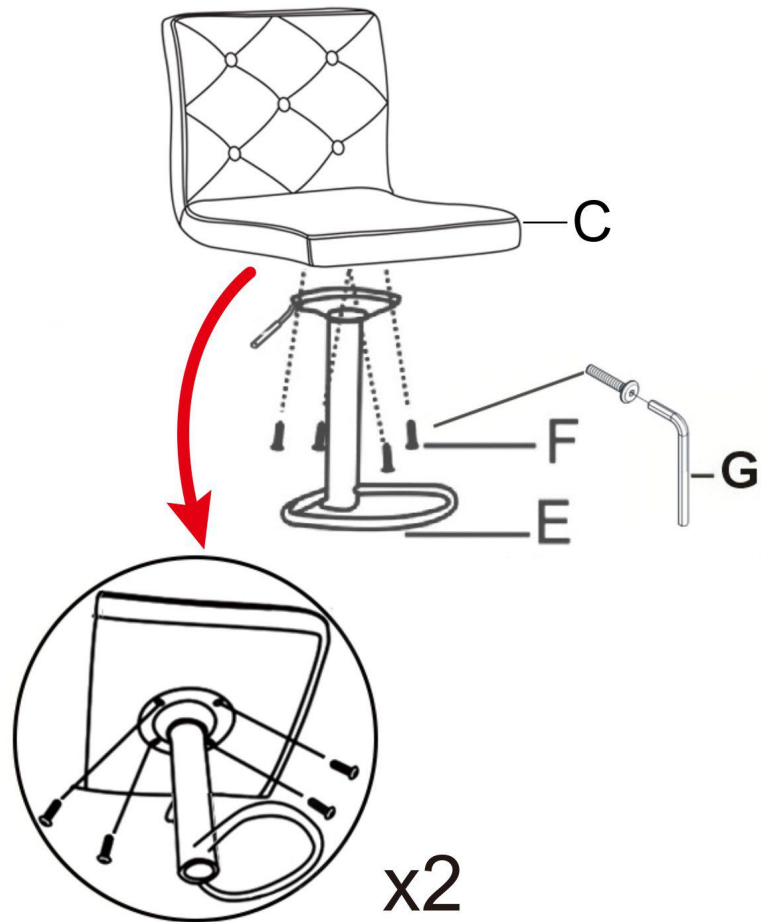

2. Find seat(C); Install footrest(E) under seat(C); Fix it with screws(F)

## Step 3

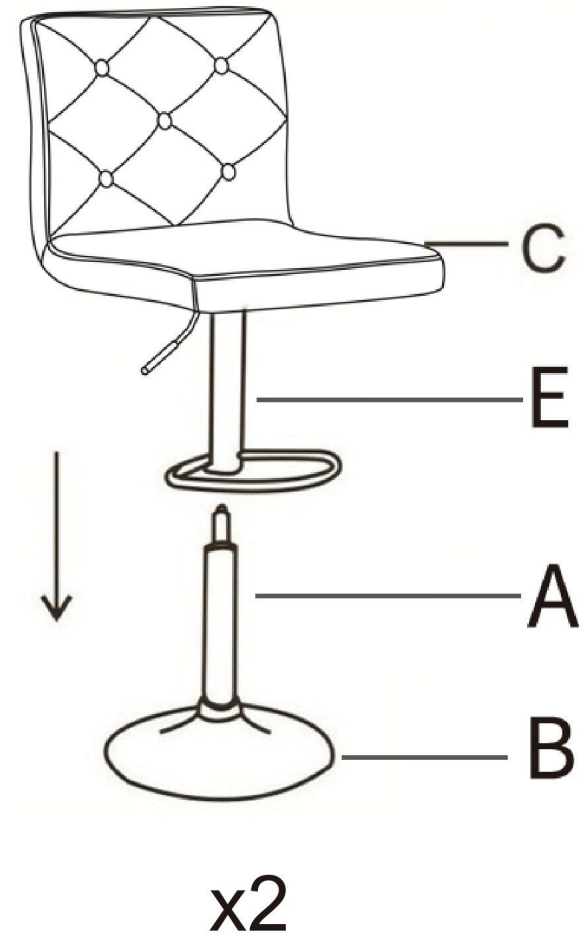

3. Install seat(C) and footrest(E) on hydraulic bar(A) which is already fixed on the base(B)