



SPECIFICATIONS

COS-QS90 Range Hood



Size	36 Inch
Mounting Type	Under Cabinet
Controls	Touch with LCD Display, Remote
Filters	3 x Stainless Steel Baffle Filters
Material	430 Grade Stainless Steel
Air Flow	500 CFM
Noise Level	40 dB*
Vent Style	External
Lighting	2 x Front LED
Voltage	120V / 60Hz
Wattage	236W
Included Components	Bulb(s), Damper, Exhaust Vent, Fan Hardware, Installation Kit, Power Cord

COS-QS90

Presenting this professional style range hood, Cosmo's COS-QS90 Range Hood is powered by 500 CFM of suction, LED lights and ARC-FLOW® Stainless Steel Permanent Filters.



4 Fan Speeds



Soft Touch Controls



LED Lighting

Features

- Designed for under cabinet mounting
- 4 fan speeds
- 500 CFM airflow capacity
- Soft touch controls with LCD display & remote control
- ARC-FLOW® permanent filters
- Front LED lights
- Noise level as low as 40 dB*
- Top vented



See Page 2 for dimensions

For more information, please visit: www.cosmoappliances.com

* Noise level as low as 40 dB on lowest fan speed with rigid ducting (sold separately) under optimal conditions



DIMENSIONS

COS-QS90 Range Hood

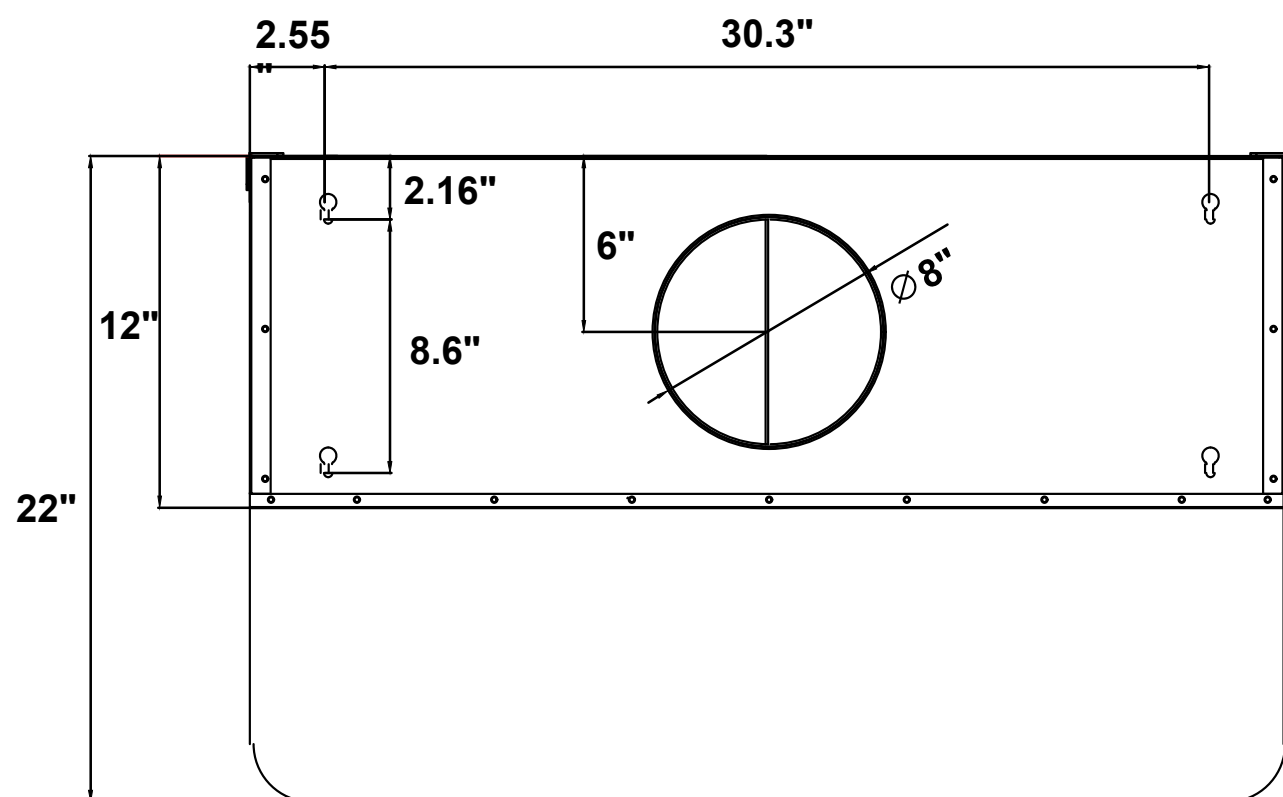
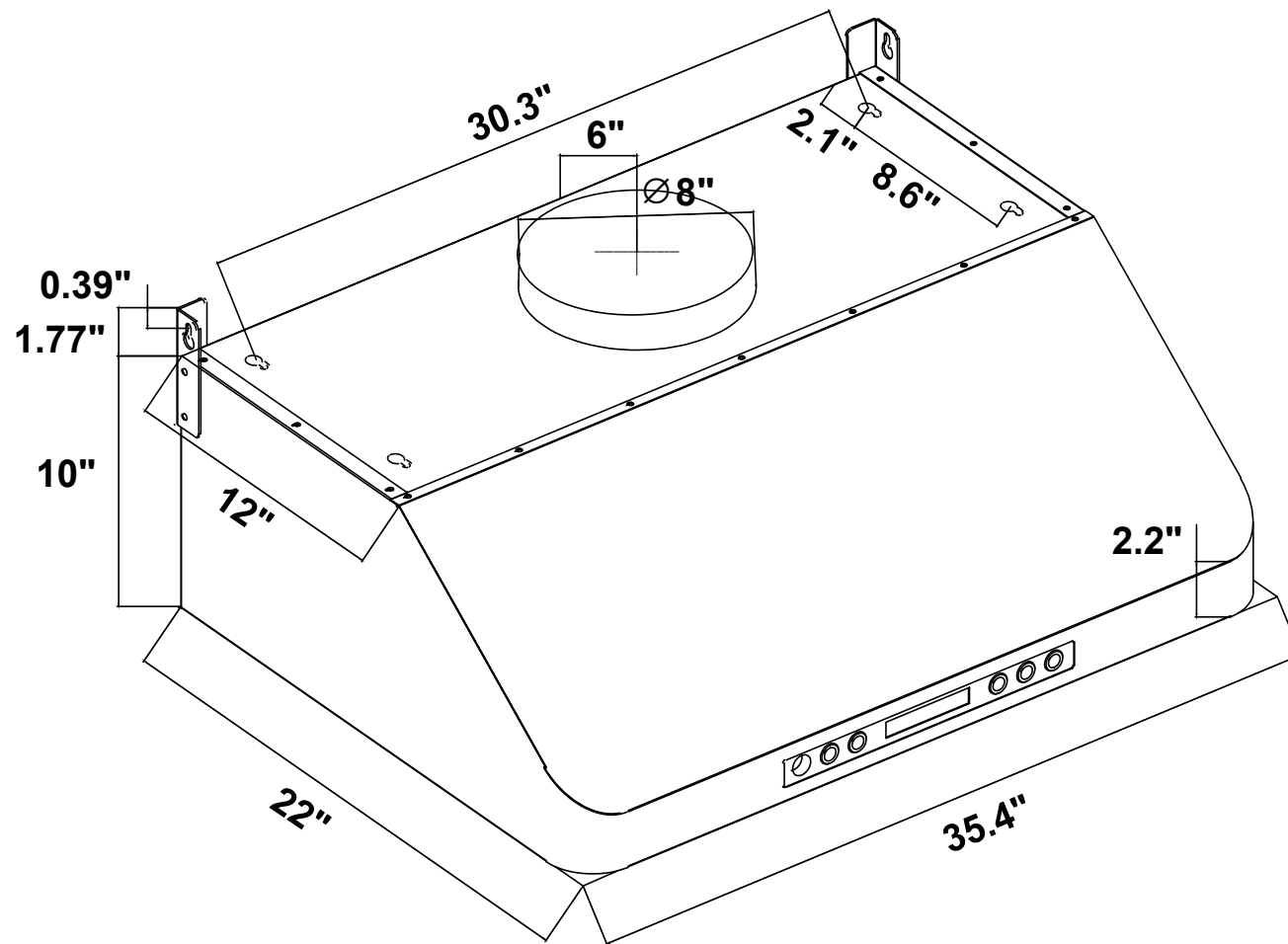

TOP VIEW

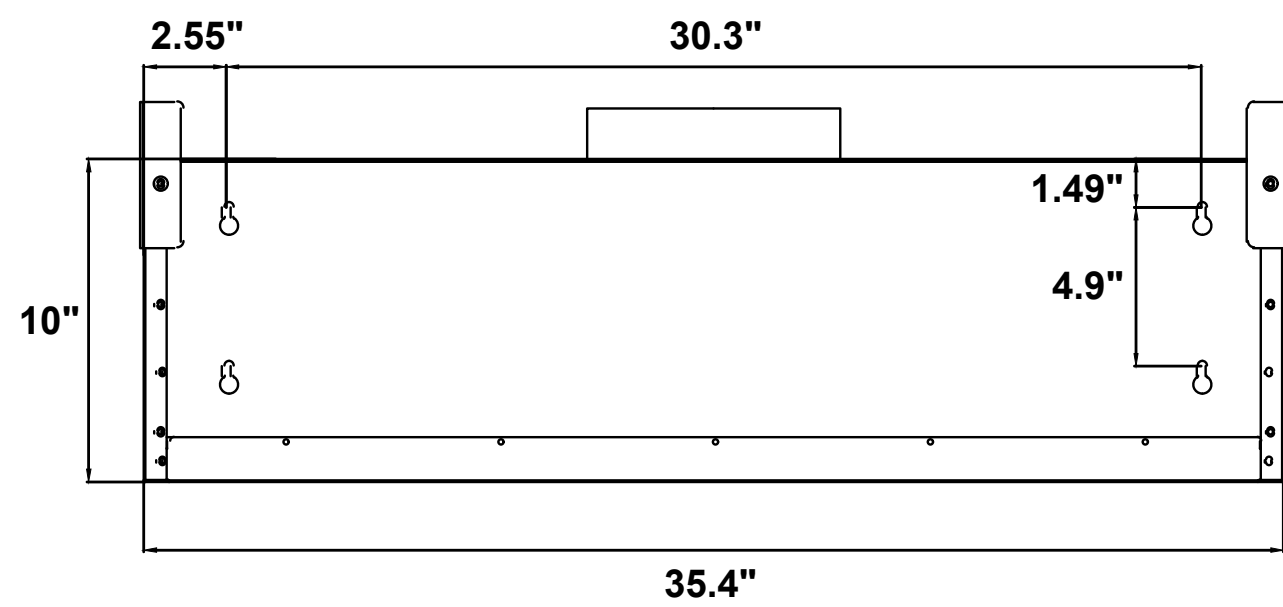

BACK VIEW

Dimensions (WxDxH): 35.4" x 22" x 10"