



INSTALLATION AND CARE GUIDE

SOLID SURFACE BATHTUB

B390W

B390M

B380

B060

B320

B540

B090



READ ALL INSTRUCTIONS BEFORE UNPACKING THE PRODUCT

INSTRUCTIONS THAT, IF IGNORED COULD RESULT IN DEATH OR SERIOUS INJURY CAUSED BY INCORRECT HANDLING OR INSTALLATION OF THE PRODUCT. THESE INSTRUCTIONS MUST BE OBSERVED FOR SAFE INSTALLATION.

HEAVY!



**TEAM LIFTING
REQUIRED**

**TEAM ARE REQUIRED TO LIFT AND DURING
ENTIRE INSTALLATION OF THIS PRODUCT**

This product must be installed by a fully insured and licensed bathtub installer.

We are not responsible for local code compliance for this product, Building and plumbing codes may vary from state-to-state in accordance to your location, We are not responsible for providing any compliance certifications.

Under no circumstances we are liable for any and all incidental damages sustained in connection with this product. Neither manufacturer, distributor or retailer is responsible for water damage or flood caused by the usage of this product.

Under no circumstances we are liable for any and all fees, cost of installation/reinstallation/removal, subsequent damages or transportation in case of the product defect.

Please don't hesitate to contact us if you have any questions or concerns.
e-mail: ysd-wf-after-sale@outlook.com

Bathtub accessories

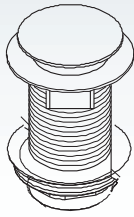

launching device

x1

size: 80x80x106mm

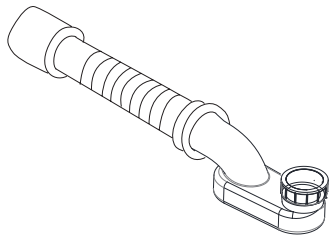

flexible pipe

x1

size: length 1000mm

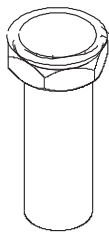

metal calandria

x1

size : 203x45mm

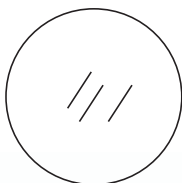

sandpaper

x2

size : ϕ 120mm

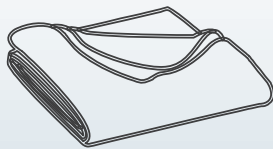

cloth

x1

TOOLS REQUIRED FOR INSTALLATION (NOT INCLUDED)

OTHER TOOLS MAY BE REQUIRED



Soft Cloth
or Blanket

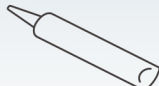

Silicone



Tape
Measure



Pencil/Marker



Hacksaw



Safety Glass



Knife

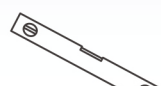

Level



Caulk Gun



Adjustable
Wrench



Channel
Lock Pliers



Plumber's Tape

Inspect the bathtub for any damages. If any damage is found please contact your retailer.

BEFORE INSTALLATION

CAUTION: Risk of personal injury. This bathtub is extremely heavy. Obtain sufficient help to lift and move the tub.

IMPORTANT!

- (1) To ensure a successful installation, install the bathtub on a level finished and structurally floor.
- (2) Observe all local plumbing and building codes.
- (3) Check that all parts are included. Make sure you locate all the parts before discarding the carton and packing material.
- (4) Unpack and inspect the bathtub for damage. If there is any missing parts or damage is found, please contact the seller for assistance. Do not install it, return the bathtub to the carton.
- (5) No claims for damages or blemishes will be accepted once tub has been installed.
- (6) Carefully moving the bathtub to the installation area. This bath is heavy and will not easily fit through doorways.
- (7) Provide drain access from below and access to all plumbing connection.
- (8) Because of the weight and volume of the tub, we strongly recommend that this installation be done by qualified licensed professional and with the help of at least one other person, a fall may seem like minor but may result in cracking on tub. Moving straps and rubber gripped gloves are highly recommended.
- (9) Tub drain and brass tailpiece are supplied with the product, however other accessories like slip joint, P-Trap and adapter are not included and must be purchased separately.

INSTALLATION STEPS:

1. Determine the installation location. Position the tub at the desired location, mark the perimeter of the tub with pencil and the location of where the tub drain will be situated, remove the tub, and place it on a soft blanket or cardboard.

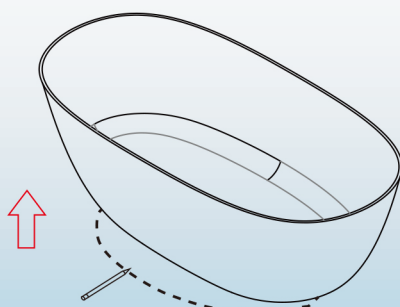

2. Install a PVC or brass drainpipe, make sure the drainpipe extends above the finished floor.

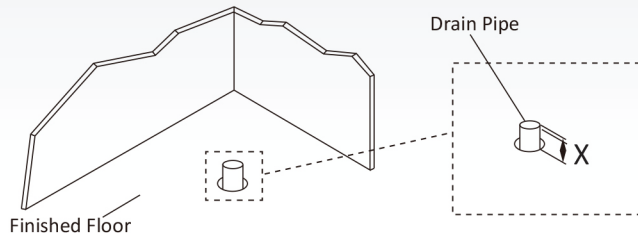

3. Place 2 pieces of lumber (4" x 4"), long enough to span the width of the tub and place them on each side of the drainpipe to temporary support the tub.

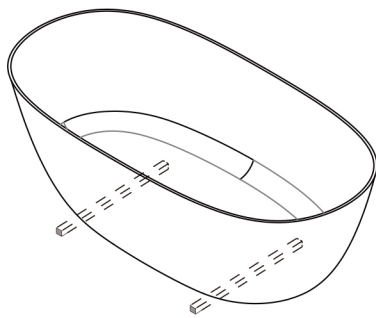

4. Team lift the bathtub on top of the lumber support rails and carefully reposition the tub, so the drain is directly over the drainpipe. Secure brass tail piece to the bottom of the drain or using a flexible drain and gently lower and adjust the tub position to ensure the drainpipe is in the center of the drain hole.

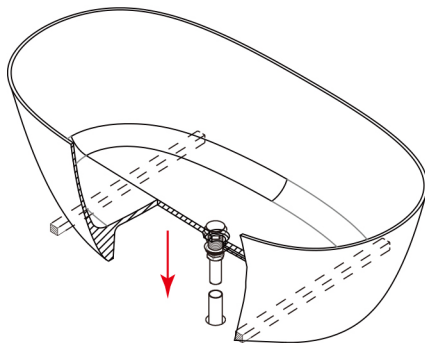

5. Close the drain and fill $\frac{1}{4}$ tub with water, allow the water to stand for 30 minutes, check for leaks. Tighten the drain and tailpiece is needed.
6. Verify the bathtub is level, install shims (not provided) as needed.

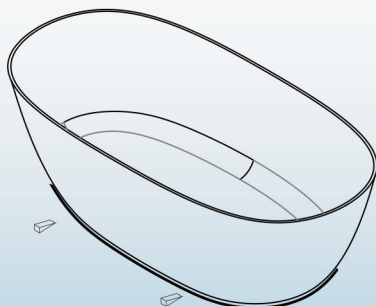

2. Install a PVC or brass drainpipe, make sure the drainpipe extends above the finished floor.

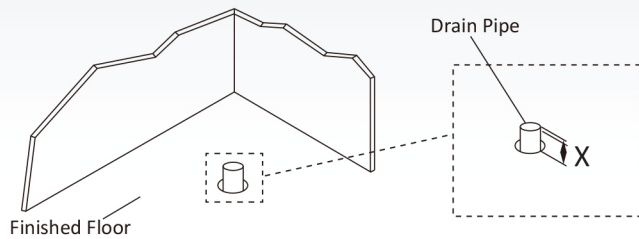

3. Place 2 pieces of lumber (4"x4"), long enough to span the width of the tub and place them on each side of the drainpipe to temporary support the tub.

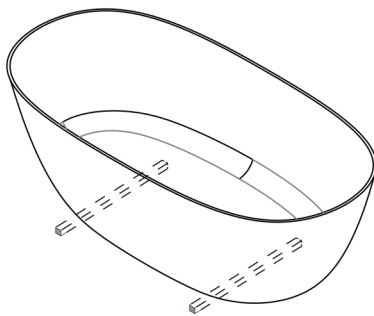

4. Team lift the bathtub on top of the lumber support rails and carefully reposition the tub, so the drain is directly over the drainpipe. Secure brass tail piece to the bottom of the drain or using a flexible drain and gently lower and adjust the tub position to ensure the drainpipe is in the center of the drain hole.

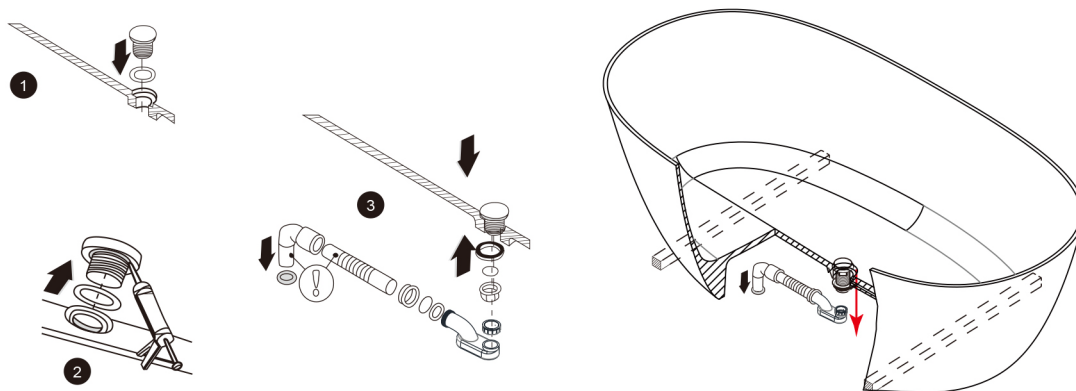

5. Close the drain and fill $\frac{1}{4}$ tub with water, allow the water to stand for 30 minutes, check for leaks. Tighten the drain and tailpiece is needed.
6. Verify the bathtub is level, install shims (not provided) as needed.

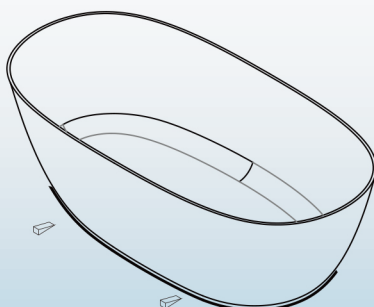

7. Apply a bead of silicone caulking around the perimeter of the tub, clean off excess caulking

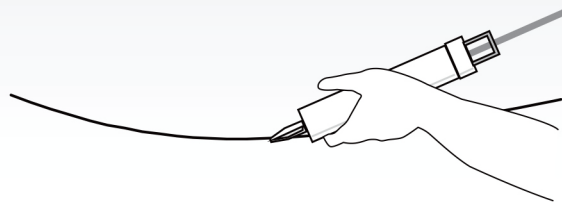

Care and Maintenance for Solid Surface Bathtub

Your new solid surface tub has been factory sealed and polished to a smooth finish, to maintain the surface and keep it looking fresh and new, it is easy to maintain the finish, however there are few do's and don'ts that need to be aware of, please care this tub in accordance with following care and maintenance tips.

Maintenance Tips:

- (1) If your tub develops minor scratches, they may be removed by scrubbing gently with fine grit sandpaper, a soft brush or non-abrasive sponge and cream cleaner.
- (2) In addition, if the minor scratches remaining after above step or you would like to polish the area in question to its original finish, you may perform following procedure.
 1. Clean the surface with water and make sure no dust remains.
 2. Using water, polish the area starting with 800grit sandpaper then final with 1000 grit sandpaper.
 3. Wipe up remaining wax with clean dry cloth.

Daily Care:

Dos:

- Use warm water to rinse the tub, wipe up water with clean and dry cloth after each use, this will maintain the tub finish and look as new.

Don'ts:

- Do not use any abrasive cleaners, cleaners containing acid, alkaline, ammonia or solvents which will cause damage in the surface.
- Do not expose the surface to hair dye or nail varnish as this may cause stains.

Please don't hesitate to contact us if you have any questions or concerns.

E-mail: ysd-wf-after-sale@outlook.com



WARRANTY

Bcan warrants its products as listed in below to be free of material and workmanship defect, subjected to the limitations set forth in this limited warranty.

- Bathtub, Whirlpool/Air Bubble Massage Tub, Wooden Cold Plunge: 1 Year limited to be free of defects in material and workmanship.
- Toilet and Bidet: 1 Year limited to be free of defects in material and workmanship.
- Faucet: 1 Year limited to be free of defects in material and workmanship.
- Vanity: 1 Year limited to be free of defects in material and workmanship.
- Granite, Marble, Engineered Quartz Vanity Top: 1 Year limited to be free of defects in material and workmanship.
- Medicine Cabinet, LED Mirror: 1 Year limited to be free of defects in material and workmanship.
- Stainless Steel Sink: 1 Year limited to be free of defects in material and workmanship.
- Solid Surface Shower Wall Panel, Shower Base and Vanity Top: 10 Years limited warranty to be free from material defects.
- Shower Door: Lifetime warranty on glass components and 1Year limited on other hardware.

This limited warranty is non-transferable and only applies to products purchased and installed in the United States and Canada.

This limited warranty excludes all industrial, commercial and business usage. Proof of purchase (original sales receipt) from the original purchaser, Description and pictures of defect, model number or model description must be provided to Woodbridge Bath for all warranty claims and Woodbridge Bath IS NOT responsible for labor cost, removal or installation costs.

This limited warranty shall not apply to goods which have been subject to accident, negligence, improper installation, product abuse, product misuse, or use of cleaners containing abrasives, alcohol or other organic solvents, whether performed by a contractor, service company, or yourself, are excluded from this warranty.

This warranty does not cover surface damaged caused by use of chemicals that break through or dissolve the surface finish or damage caused by the accidental dropping of sharp or heavy objects. Improper care and use of abrasive cleaners and will void the warranty.

During this limited warranty period if a malfunction occurs and after inspection it is determined that a defect developed during normal use, Woodbridge will as at its election proceed with any of the following options:

- (1) repair or replace the defective part(s) or product(s) at cost
- (2) issue a refund of the original purchase price of the product(s) (Valid within 30 days from the date of purchase)
- (3) issue a credit to be applied toward the purchase of a new product. Shipping/delivery charges may apply and are in sole discretion.

Caution:

NEVER use cleaners containing abrasive cleaners, ammonia, bleach, acids, waxes, alcohol, solvents or other products that are not recommended for Chrome finish will void the warranty.

Woodbridge products should be installed by a fully insured and licensed contractor only. Installation by anyone other than fully insured and licensed contractor will void this limited warranty.

RESPONSIBILITIES OF OTHERS

Inspecting the unit prior to installation is the responsibility of the installer or building contractor who acts on behalf of the user. They are responsible for ensuring the unit is free of defect or damage. Notices are placed on the unit and on the shipping carton advising the installer of this responsibility. In the event of a problem, the unit must not be installed. Woodbridge is not responsible for failures or damage that could have been discovered, repaired, or avoided by proper inspection and testing prior to installation.

Damage occurring in transit is the responsibility of the carrier. The user or installer MUST open the crate and inspect the unit for damage when it is delivered. If damage is discovered, it must be reported immediately to the seller and the carrier in writing, and an inspection requested. Failure of the carrier to respond should be reported to the seller and the carrier. Your freight claims should be filed promptly thereafter.

This limited warranty does not cover any liability for consequential or incidental damages, all of which are hereby expressly disclaimed, or the extension beyond the duration of this limited warranty of any implied limited warranties, including those of merchant ability or fitness for an intended purpose.

DISCLAIMER

Except as expressly provided, there shall be no warranty or obligation, express or implied, oral or statutory. No dealer or other person has the authority to make any warranties or representations concerning or its products. In no event shall be held responsible for any such warranties or representations.

Some states/provinces do not allow limitations on how long an implied warranty lasts, or the exclusion on limitation of special, incidental or consequential damages, so these limitations and exclusions may not apply to you. This warranty gives you specific legal rights, you may also have other rights which vary from state/province to state/province.

To obtain warranty and replacement parts, please send e-mail to ysd-wf-after-sale@outlook.com with the original receipt information, We will determine whether to repair or replace your product, issue a refund or issue a credit.

IMPORTANT!

DO NOT USE: Abrasive cleaners such as: acid, ammonia, bleach, and similar solutions. Use of such solutions may cause corrosion, finish peeling, and/or dull the surface.

DO NOT USE: Abrasive sponges or cloth. Never use steel, wool, or wired brushes that will permanently scratch the

Retain these installation instructions for future reference!

Thank you for using products!

Scan the WhatsApp QR code below to contact our customer service team to solve your problem

Bcan WhatsApp



Thank you for being our valuable customers!

Please feel free to get in touch with our after-sale service team if you have any problems, we will get back to you as soon as we can.

Please don't hesitate to contact us if you have any questions or concerns.

Email: ysd-wf-after-sale@outlook.com