

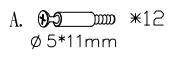

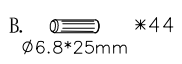

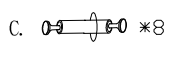

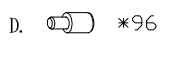



- A.  *12
Ø 5*11mm
- B.  *44
Ø 6.8*25mm
- C.  *8
- D.  *96
- E.  *6
- F.  *18
- G.  *6
- H.  *48
- I.  *4
- U.  *1

IF YOU HAVE ANY DIFFICULTY ASSEMBLING PLEASE CONTACT US

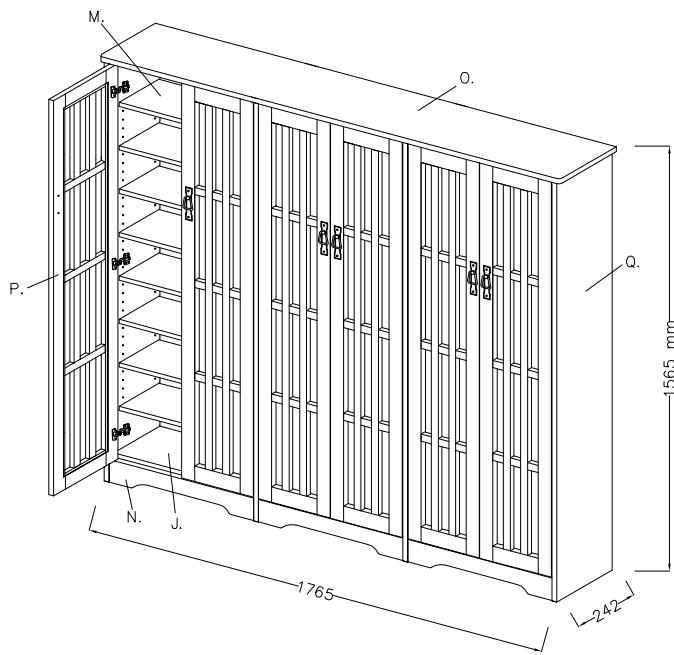

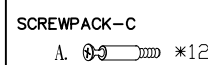
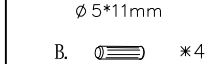
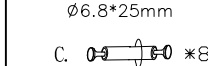
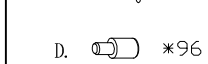
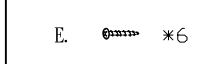
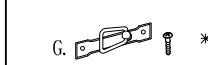
- SCREWPACK-B**
- F.  *18
- SCREWPACK-C**
- A.  *12
Ø 5*11mm
 - B.  *44
Ø 6.8*25mm
 - C.  *8
 - D.  *96
 - E.  *6
 - G.  *6
 - H.  *48
 - I.  *4
 - U.  *1
- A** Q. RIGHT and LEFT SIDE-PANELx2
R. VERTICAL CENTER-PANELx2
T. GLASS x6
O. TOP-PANELx1
- B** K. TOP-SUPPORTERx1
P. DOOR-PANEL x6 (RIGHT and LEFT)
M. SHELVES-PANELx8
S. BACK-PANELx3
SCREWPACK-B
- C** K. TOP-SUPPORTERx2
M. SHELVES-PANELx16
J. BOTTOM-PANELx3
L. HOLDING-PANELx3
N. FRONT-PANELx3
SCREWPACK-C

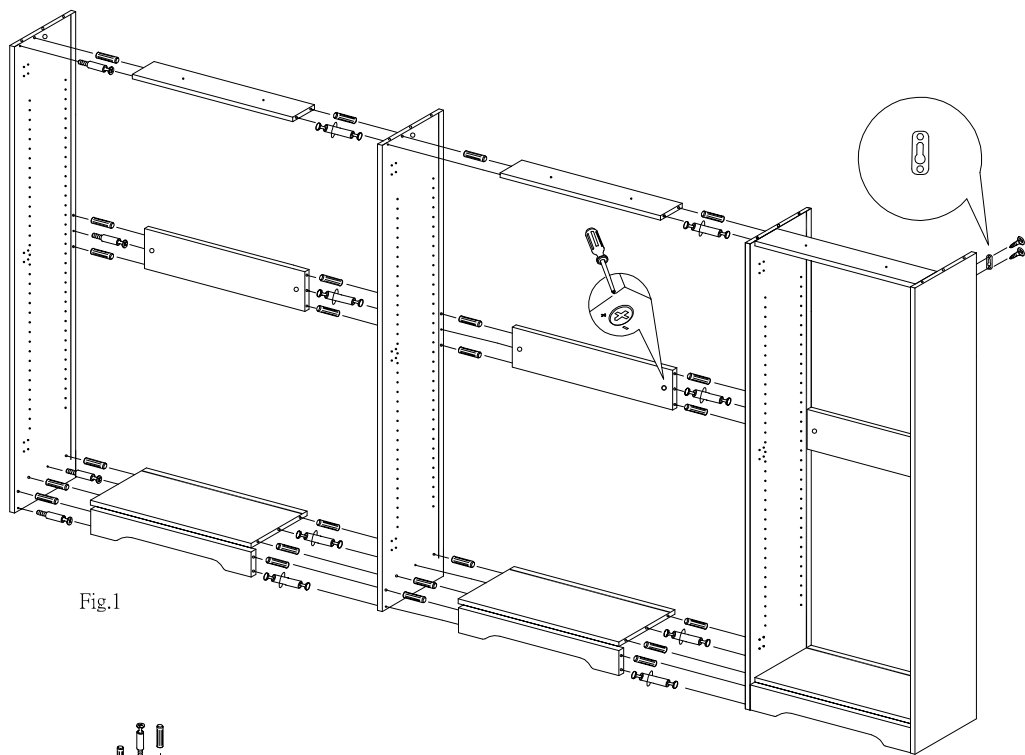
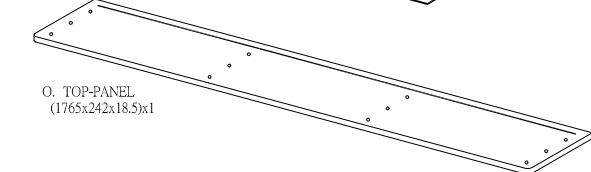
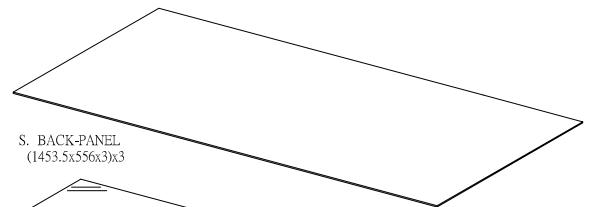
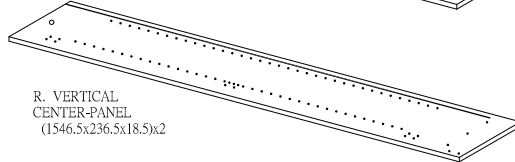
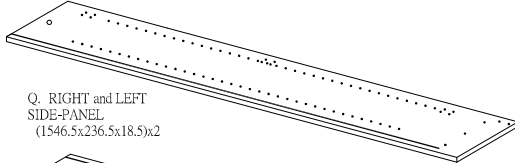
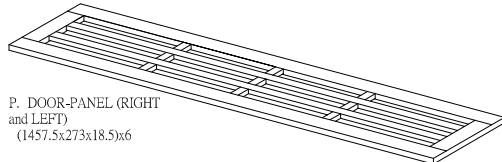
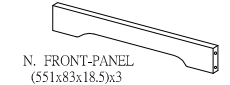
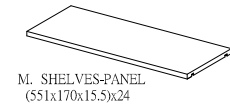
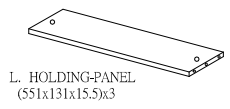
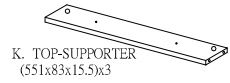
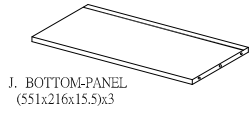

Fig.1

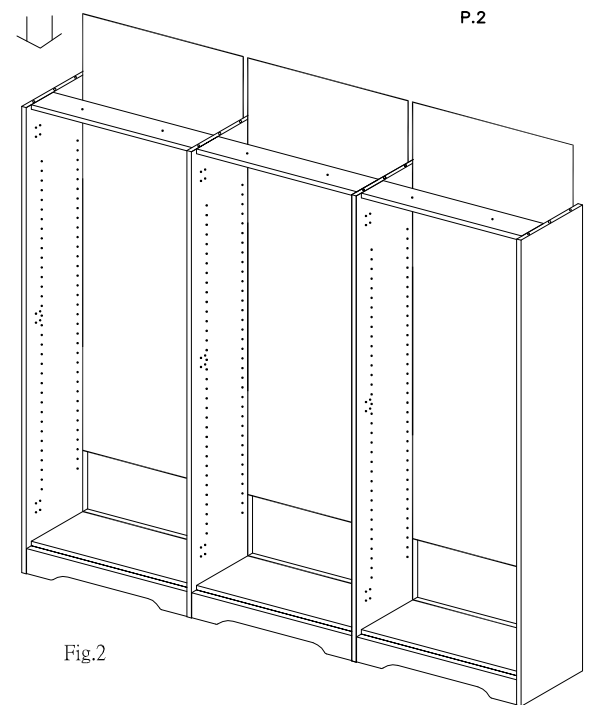

Fig.2

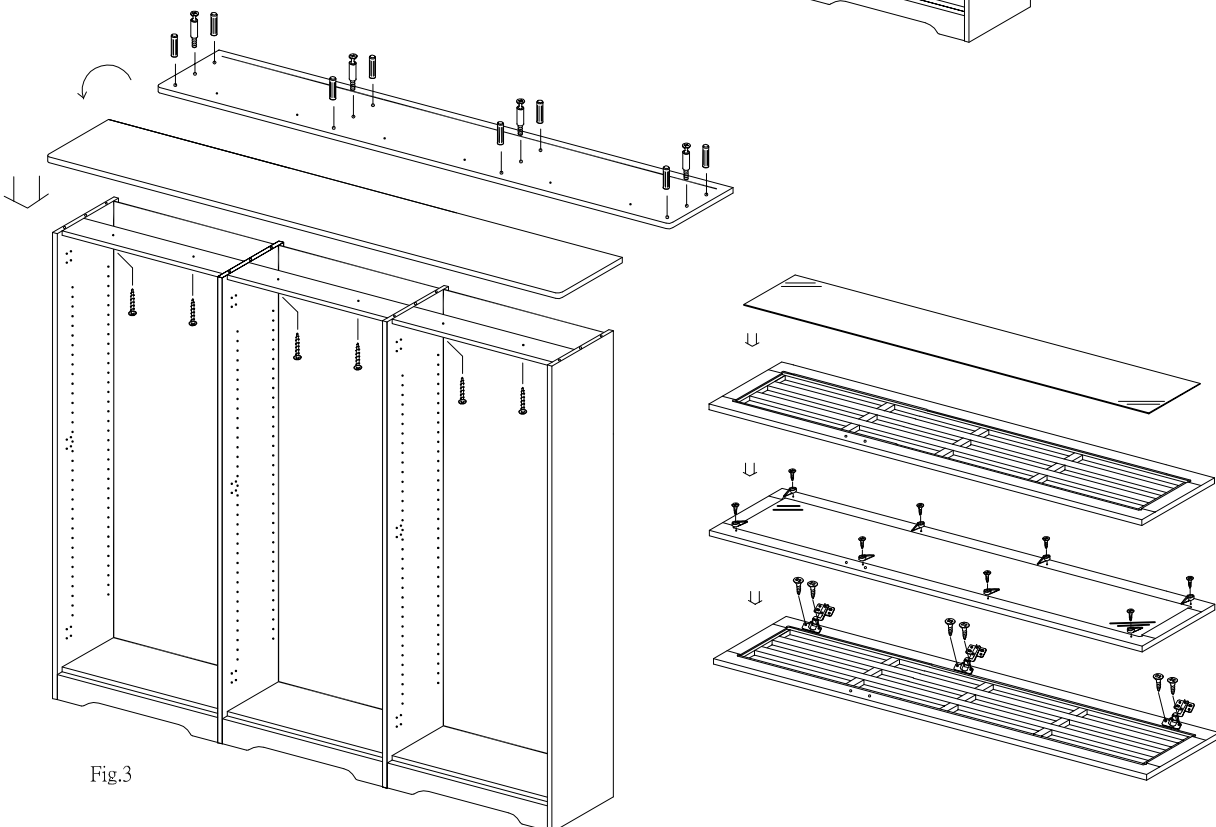

Fig.3

It is recommended to have assistance while attaching the doors.

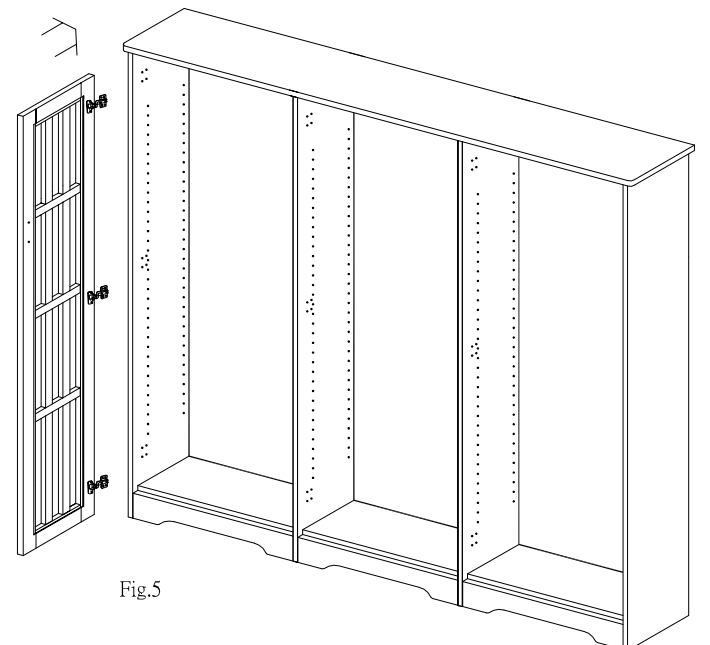

Fig.5