







ASSEMBLY INSTRUCTION

ITEM: COUNTER TABLE

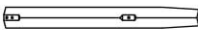
NO	PART LIST	QTY
1	 TABLE TOP	1PC
2	 SHELF	1PC
3	 LEG	4PCS
NO	HARDWARE LIST	QTY
A	 JCBC SCREW M6 X 70mm	12PCS
B	 SPRING WASHER M6 x 12mm	12PCS
C	 FLAT WASHER M6 x 19mm	12PCS
D	 L-KEY M4 x 58mm	1PC

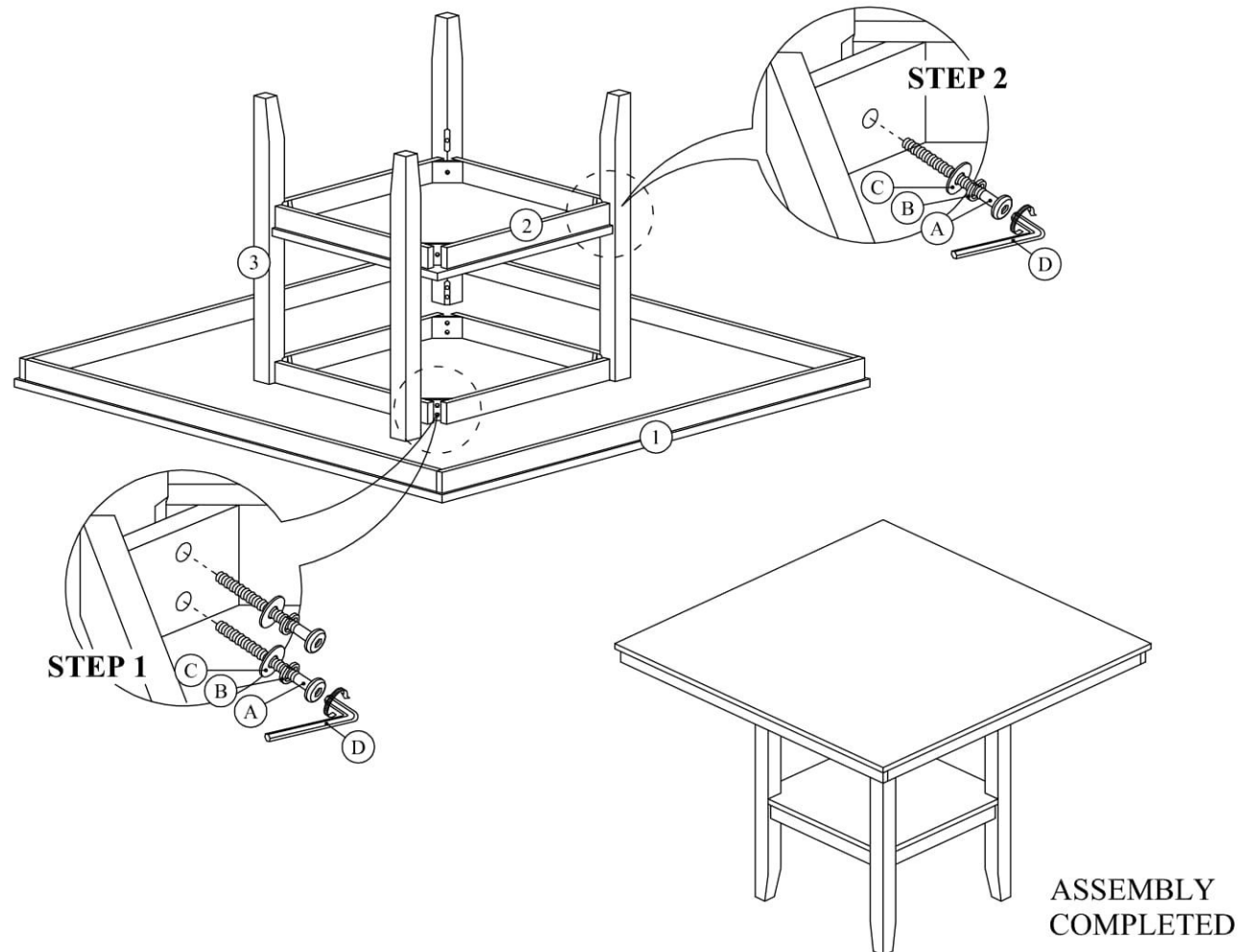

NOTE: AFTER A FEW DAYS OF ASSEMBLY, IT WILL HAVE ACCLIMATIZED TO ENVIRONMENT. PLEASE TIGHTEN ALL HARDWARE. CHECK TIGHTNESS OF ALL SCREWS EVERY 6-8 WEEKS.