







ASSEMBLY INSTRUCTION

Thank you for purchasing this quality product. Be sure to check all packing material carefully for small parts which may have loose inside the carton during shipment. Identify and count all parts and compare with the parts list below.

PART LIST#

| NO | NAME | PART | QTY |
|----|-------|---|------|
| A | Bench |  | 1pc |
| B | Leg |  | 4pcs |

HARDWARE LIST

| NO | NAME | PART | QTY |
|----|--------------------|---|------|
| 1 | Allen Key |  | 1pc |
| 2 | JCBB M8 x 60mm |  | 8pcs |
| 3 | M8 " Spring Washer |  | 8pcs |
| 4 | 5/16" Flat Washer |  | 8pcs |

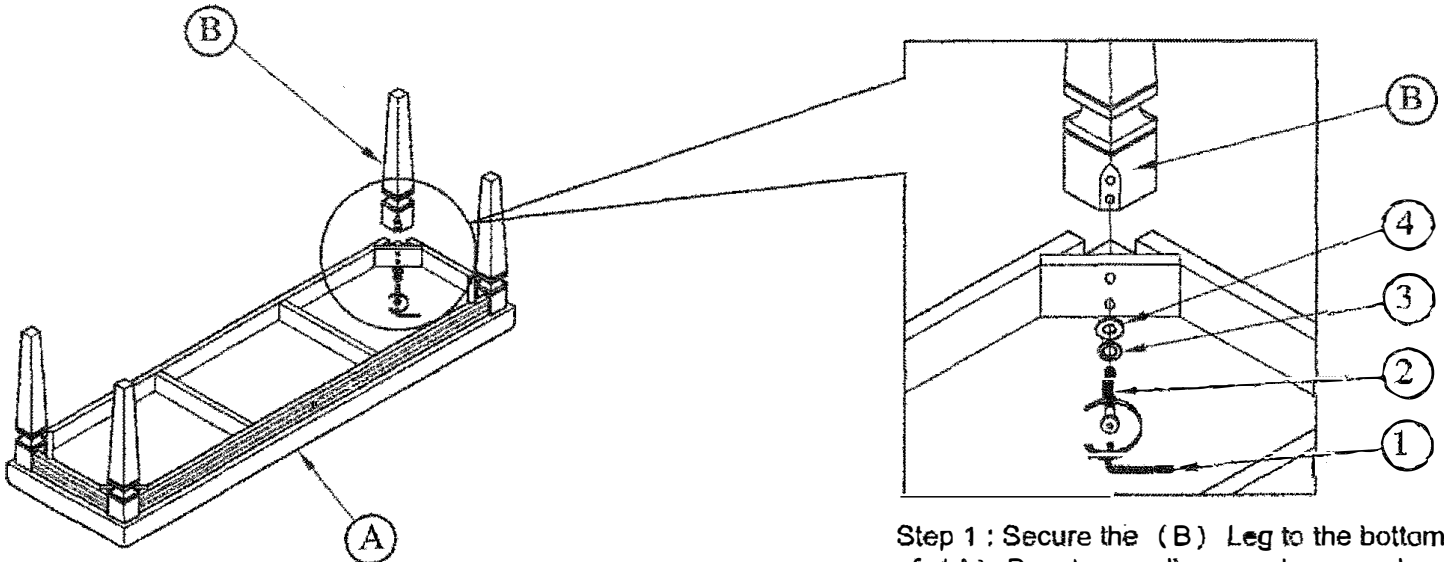

Step 1 : Secure the (B) Leg to the bottom of (A) Bench as a diagram shown and tighten with (2) JCBB M8 x 60mm, (3) M8 Spring Washer & (4) 5/16" Flat Washer.

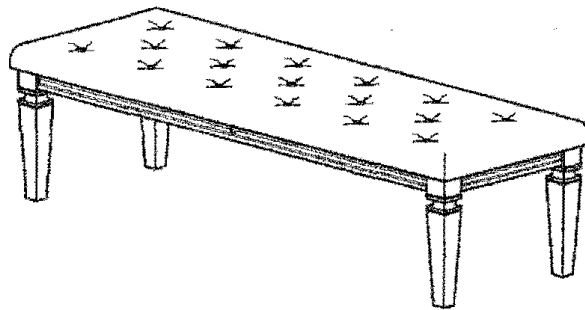

Assembly completed