

WARNING (To reduce the risk of fire, electric shock, or injury to persons):

1. We suggest installation by a **licensed electrician**.
2. Please read the instruction carefully and save it as you may need it at later time.
3. Before you start, **NEVER** attempt any work without shutting off the electricity until the work is done. A). Go to the main fuse, or circuit breaker, box in your home. Place the main power switch in the "**OFF**" position. B). Place the wall switch in the "**OFF**" position.
4. Mounting surface should be clean, dry, flat, strong enough and 1/4" larger than the canopy on all side. Any gaps between the mounting surface and canopy exceeding 3/16" should be corrected as required.
5. Make sure that the ceiling or wall can stand the weight of the lamp before fixture.
6. Make sure the voltage you are using is **120V**. The maximum wattage is **60W** per bulb.
7. Keep the lamp away from acidic and basic objects in case of damaging the surface of the lamp.
8. When replacing bulb, you should turn off or unplug the lamp and you must wait until it is cool as bulbs get hot quickly.
9. The safety instructions appearing in this manual are not meant to cover all possible conditions that may occur. It must be understood that common sense, caution and care must be used with any electrical products.

IMAGE FOR FINISHED PRODUCT:

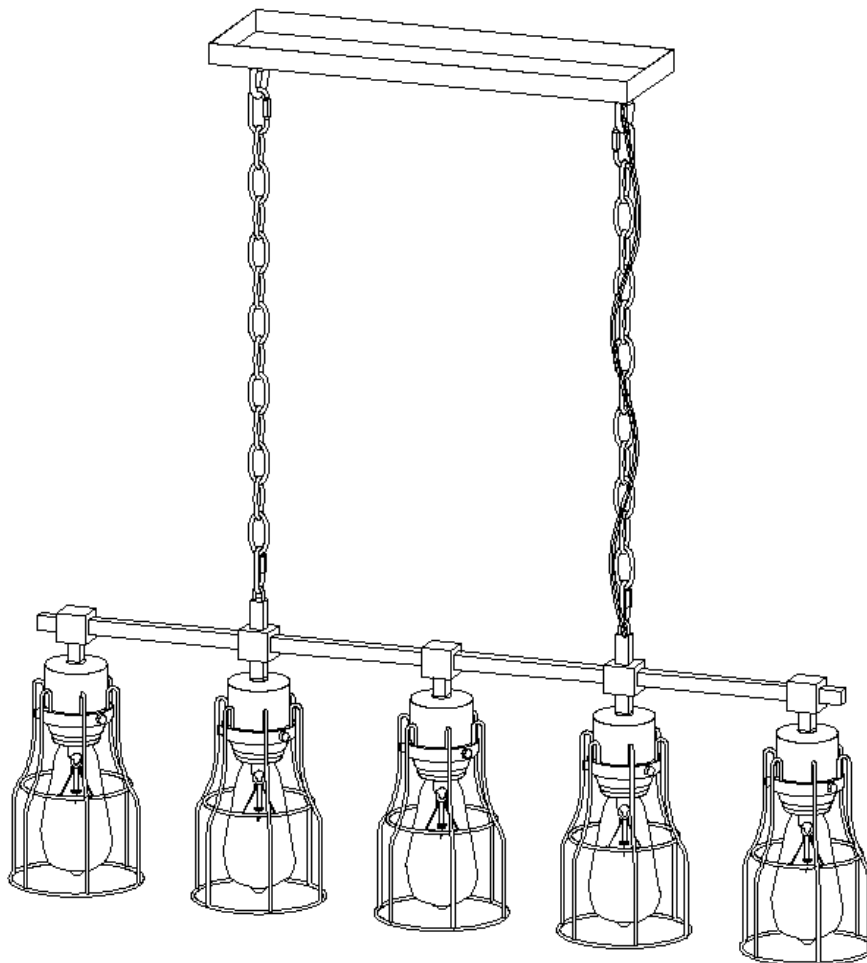

TOOLS REQUIRED (NOT INCLUDED):

Before doing assembly and installation please prepare the needed tools as below picture

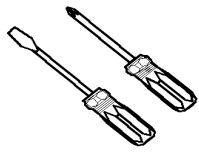
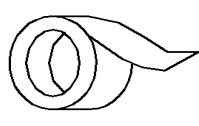
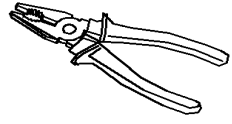
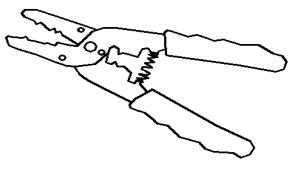
				
Ladder	Phillips head.flat blade screwdriver	Electrical tape	Pliers	Wire cutter/Stripper

PARTS TYPE & QTY INCLUDING:

- (E) Mounting plate assembly (1)
- (F) Green ground screw (1)
- (G) Ball knob (2)
- (H) Canopy (1)
- (I) Loop (2)
- (J) Quick link (4)
- (K) Chain (2)
- (L) Iron tube (1)
- (M) Socket (5)
- (N) Screw (15)
- (O) Wire lampshade(5)

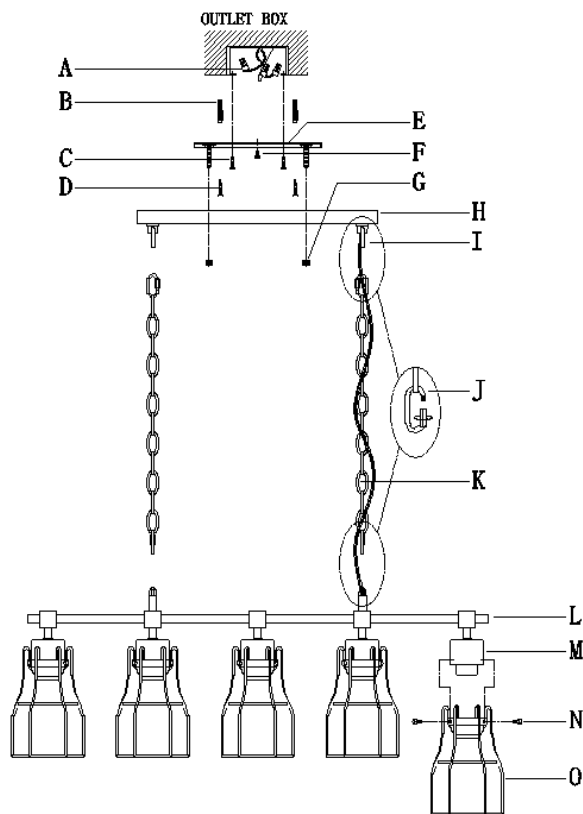

ACCESSORIES & QTY ENCLOSED:

- (A) Wire connector (3)
- (B) Anchor (4)
- (C) Mounting screw (2)
- (D) Wood screw (4)
- (N) Screw (1) spare parts

ASSEMBLY & INSTALLATION INSTRUCTIONS:

1. Carefully remove the fixture from the carton and check that all parts and accessories are included as shown in the above illustration.
2. Make pre-installation

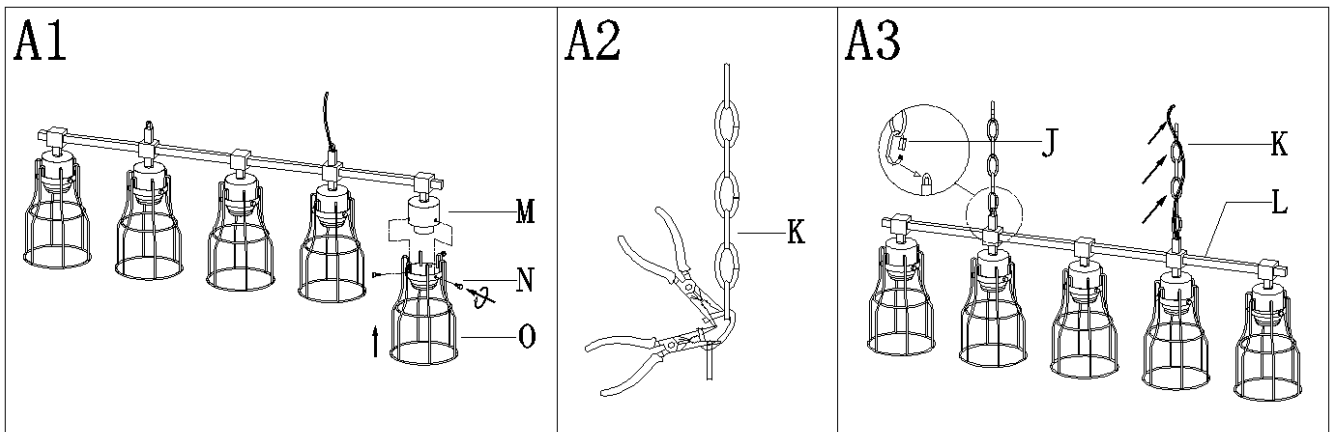

Step A1: Fix the wire lamp shade (O) to the socket (M) with screws (N).

Step A2: By measuring, determine the correct number of links needed for proper hanging height. Using the chain pliers, disconnect and discard the remaining chain.

Step A3: Attach the quick link (J) to connect the chain (K) and the loop on the the top of iron tube (L).

Carefully lace the wires through the chain (K)(every other link)and stop just before you reach the top of chain (K).Gently pull the wires till snug.

3. Turn off power

Before you start to make installation, NEVER attempt any work without shutting off the electricity until the work is done. A). Go to the main fuse, or circuit breaker, box in your home. Place the main power switch in the "OFF" position. B).Place the wall switch in the"OFF" position.

4. Make installation

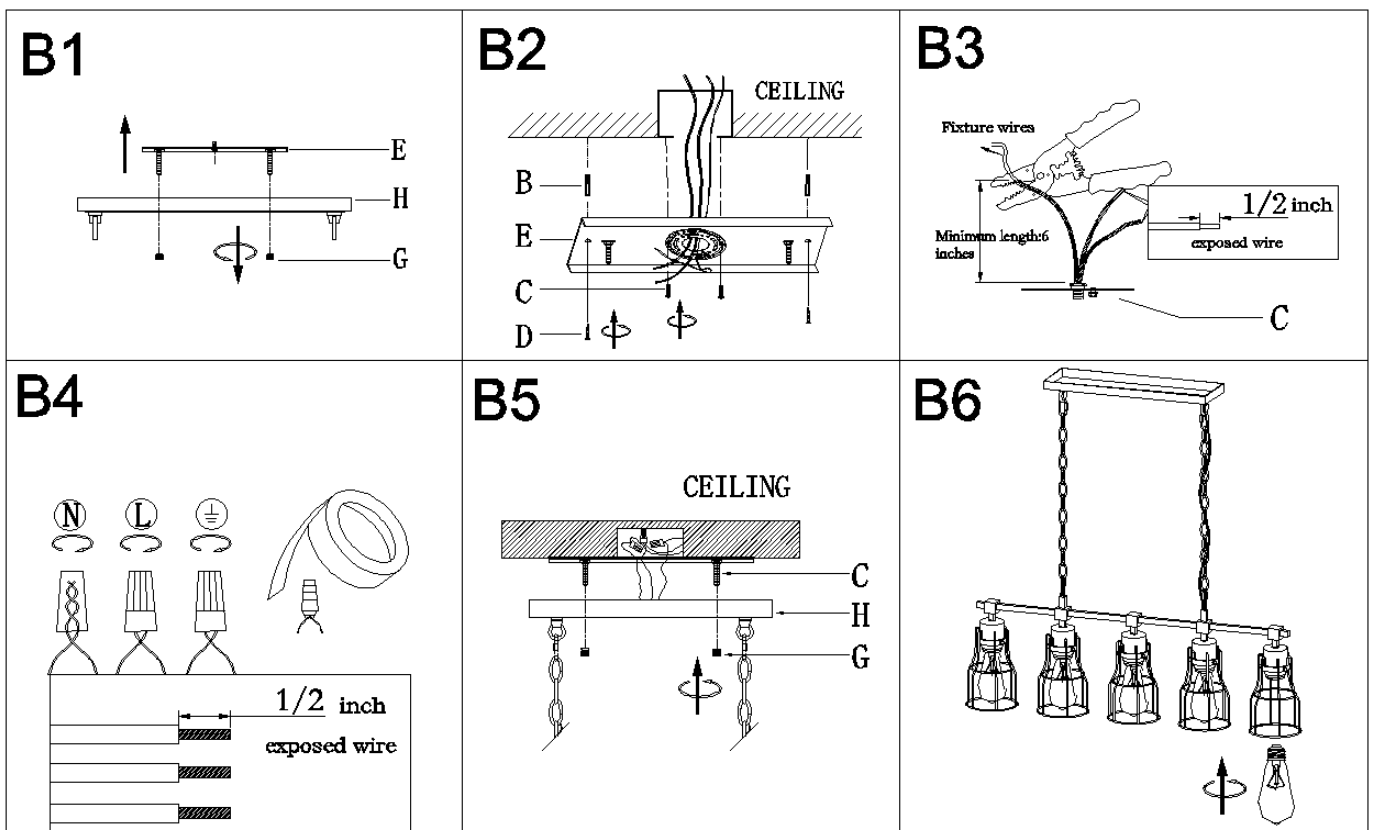

Step B1: Unscrew the ball knob (G) from mounting plate assembly (E) .

Step B2: Attach the mounting plate assembly(E) to ceiling with the mounting screws (C) and wood screw (D).

Step B3: If needed, cut off the wires length of fixture.At this point, the remaining wire length measured from the top mounting plate assembly (E) is at least 6".

StepB4: Make wire connections

Connect wires as below wires connecting shown. **TAKE NOTE OF YOUR WIRE COLOR OF FIXTURE ,NEVER CONNECT WIRE TO GROUND WIRE**

Connect ground wire according to below chart

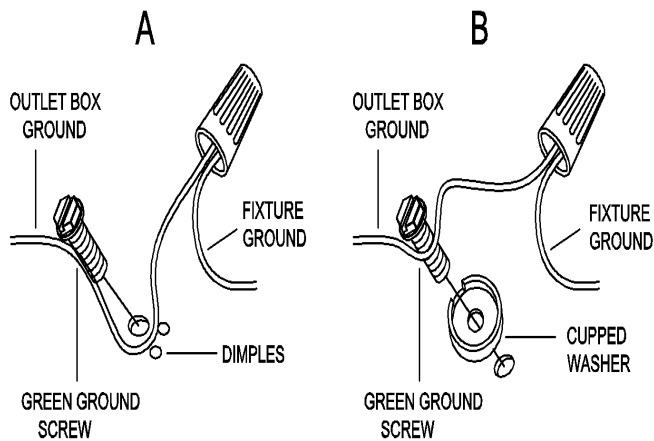

Connect wires according to below chart

Connect Black or Red Supply Wire to:	Connect White Supply Wire to:
Black	White
*Parallel cord (round & smooth)	*Parallel cord (square & ridged)
Clear,Brown,Gold or Black without tracer	Clear,Brown,Gold or Black with tracer
Insulated wire (other than green) with copper conductor	Insulated wire (other than green) with silver conductor

*Note: When parallel wires (SPT I & SPT II) are used. The neutral wire is square shaped or ridged and the other wire will be round in shape or smooth (see illus.)

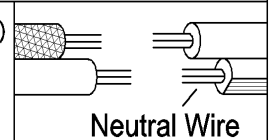

Twist plastic wire connector until wires are tightly joined together,wrap each connector with approved electrical tape.Be sure that no wire strands are exposed and then carefully tuck all wires into the outlet box .

Step B5: Raise canopy (H) to ceiling and secure canopy (H) in place by ball knobs (G) onto the threaded nipple on mounting plate assembly (E).

Step B6: Install bulbs (not included) (Please do not exceed the maximum capacity recommended on the socket.)

Check ything is already installed properly, then you could turn on the light. Enjoy!

CLEANING.

To clean, wipe fixture with a soft cloth. Do not use abrasive materials such as scouring pads or powders, steel wool or abrasive paper.

ORDERING PARTS.

Keep this sheet for future reference, and in case you need to order replacement parts. All parts for this fixture can be ordered from place of purchase. Be sure to use exact wording from illustration when ordering parts.