











# Assembly Instructions

**Caution: You must read this before you proceed**

## Care & Maintenance

	<ul style="list-style-type: none"><li>● Not for commercial use. For residential use only.</li></ul>
	<ul style="list-style-type: none"><li>● Furniture may scratch floors. We recommend using furniture pads to protect your floors.</li></ul>
	<ul style="list-style-type: none"><li>● Do not put hot items directly on furniture surface.</li></ul>
	<ul style="list-style-type: none"><li>● Do not clean furniture with harsh cleansers or polish.</li></ul>
	<ul style="list-style-type: none"><li>● Do not place furniture under direct sunlight.</li></ul>
	<ul style="list-style-type: none"><li>● Do not place furniture near heating or cooling vents.</li></ul>
	<ul style="list-style-type: none"><li>● Do not write on furniture without a padded barrier to protect the surface.</li></ul>
	<ul style="list-style-type: none"><li>● Do not place furniture outside . For indoor use only.</li></ul>
	<ul style="list-style-type: none"><li>● Stains may be removed with mild soap solution and damp cloth.</li></ul>
	<ul style="list-style-type: none"><li>● Children should not climb or jump on the furniture.</li></ul>
	<ul style="list-style-type: none"><li>● Dust and pick-up spills using a clean, non-colored, lint-free cloth.</li></ul>



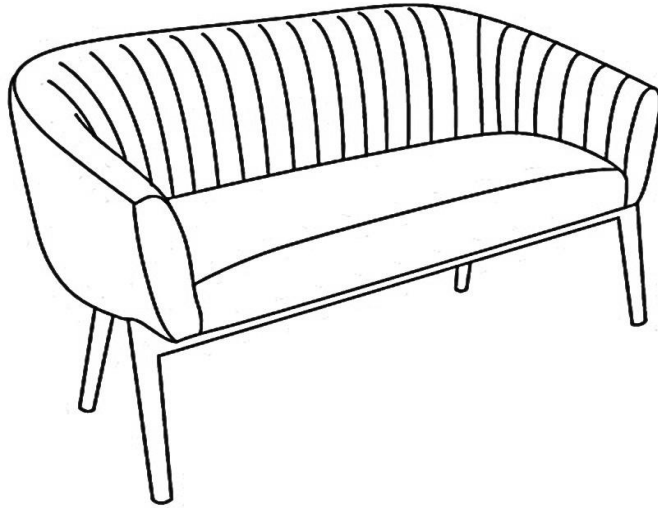

# Loveseat



## Part List

Label	Picture	Description	QTY
A	A line drawing showing the base of the loveseat, which is a rectangular frame with a curved front edge and a curved back edge.	Loveseat Base	1
B	A line drawing of a single front leg, which is a straight piece of wood angled outwards from the base.	Front Leg	1
C	A line drawing of a single back leg, which is a straight vertical piece of wood.	Back Leg	2

## Hardware

Label	Picture	Description	QTY
①		Bolt (M8*60mm)	4
②		Allen Wrench	1
③		Washer	4
④		Spring Washer	4
⑤		Gasket	3

## Assembly Preparation

Before Beginning Assembly:



A



B



C

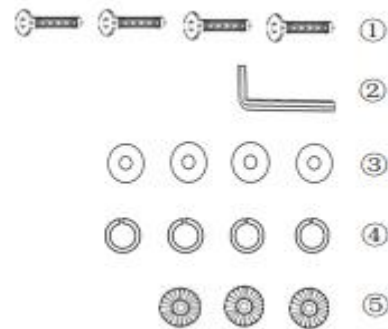

• Read instructions, cover to cover-



• Have 2 adults on hand for assembly-



• Do not assemble on flooring or carpet-



• Assemble on a clean non-marring surface (packing foam)-



• Save all packaging until finished-

## Assembly Steps

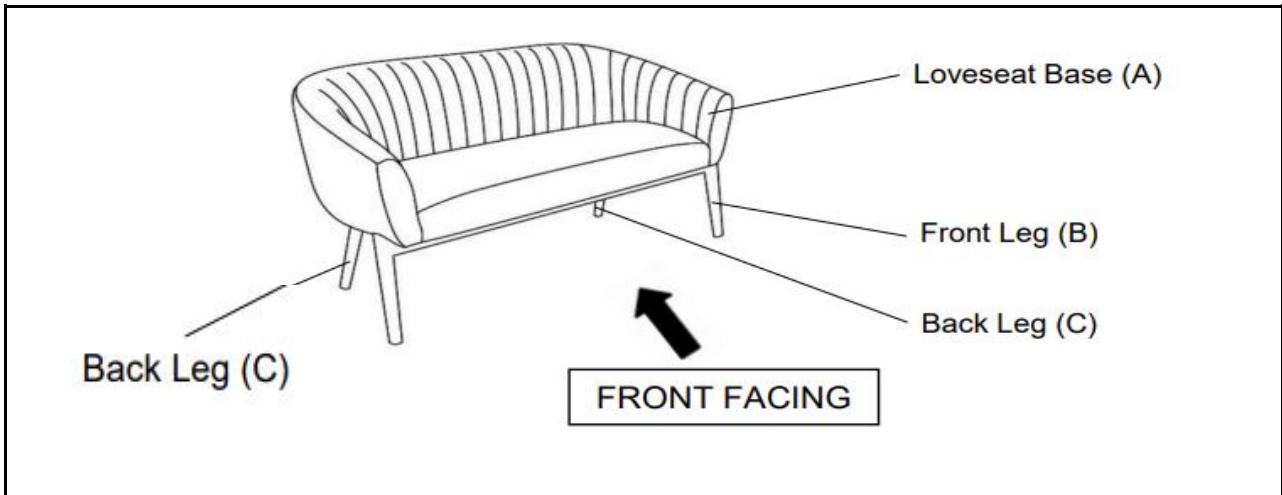

This Loveseat has multiple parts and may require up to 30 minutes to assemble. To give you an overview of the Loveseat parts, the above picture is to help you put the various parts into perspective. Please read through the instructions below to familiarise yourself with the parts and steps before assembly.

**Step 1**

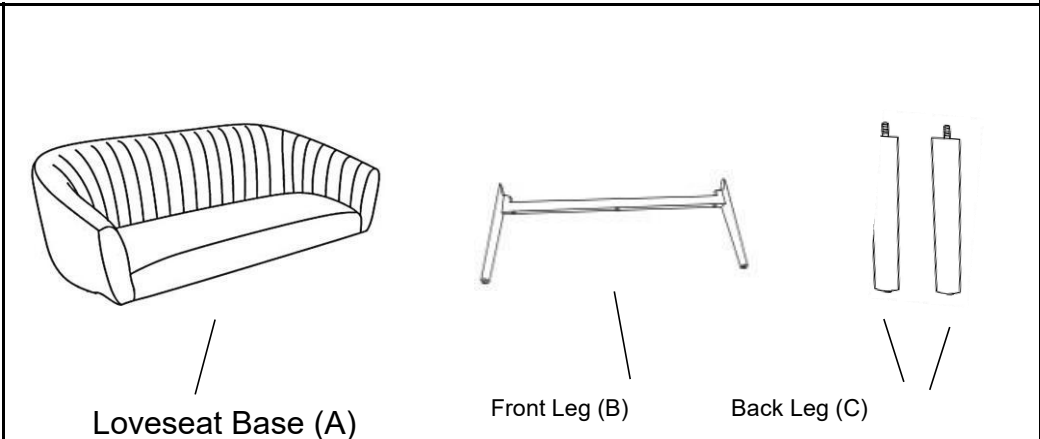

Place the Loveseat Base(A), Front Leg(B) and Back Legs(C) on a clean, non-marring surface.

**Step 2**

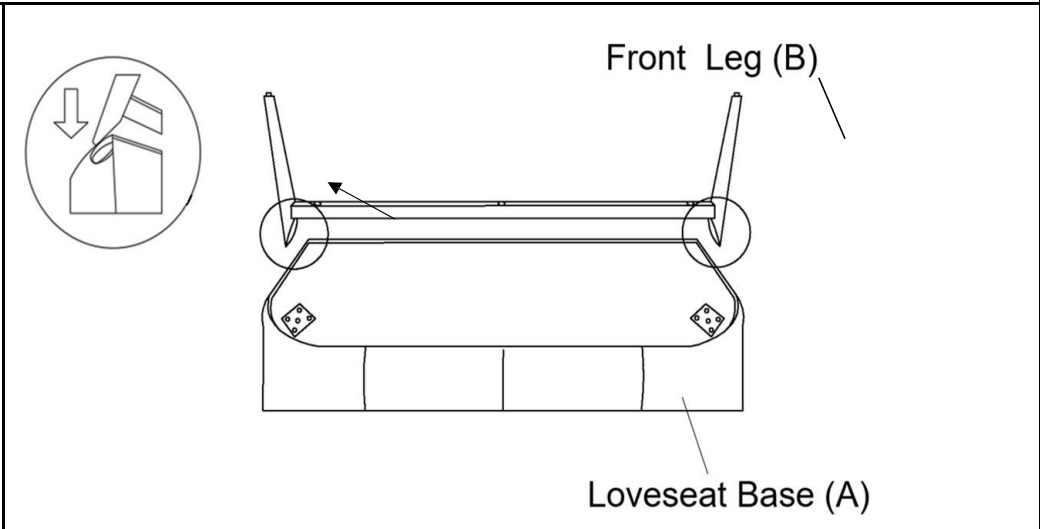

Position Loveseat Base(A) on its back as shown. Insert Front Leg(B) into the outside of Loveseat Base(A), and align the three mounting positions as pictured above.

### Step 3

Loveseat Base (A)

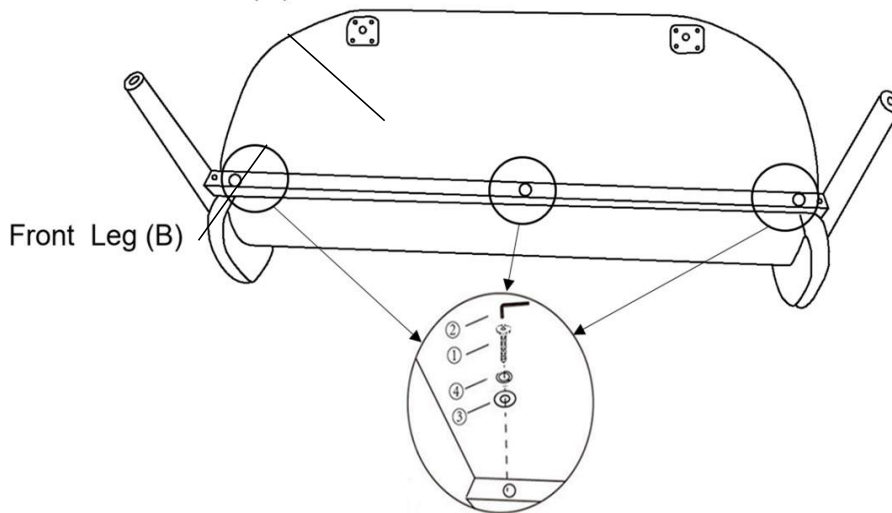

Attach Front Leg(B) to Loveseat Base(A) using Bolts(④), Spring Washers(④), and Washers(③) with Allen Wrench(②).

**Tighten the Bolts fully in a sequential manner.**

### Step 4

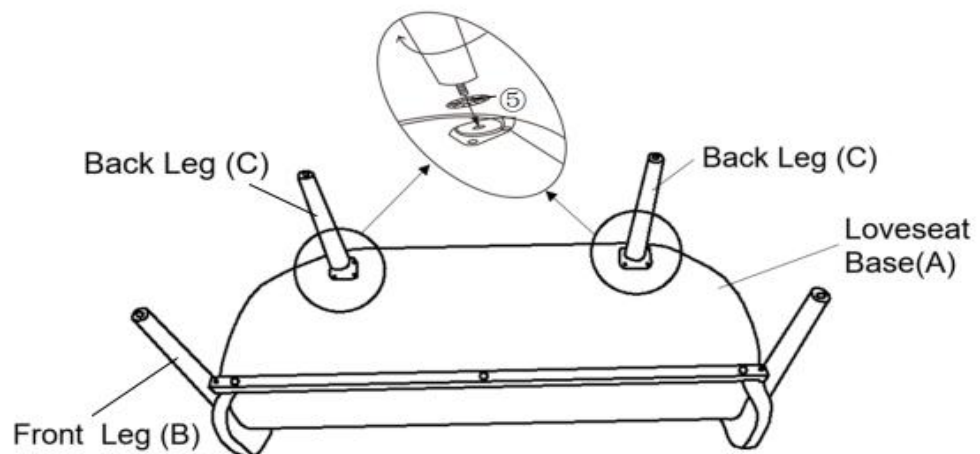

Install the Back Leg(C) at the bottom of the Chair by placing one Gasket(⑤) on the threaded stem. Then insert threaded stem into the threaded mounting position at the corner of the Chair.

Tighten by turning the Leg clockwise.

**Repeat the same step to install the remaining Leg.**

**Note: The use of Gaskets are OPTIONAL and are especially useful to help alleviate slight wobbles. Some Legs may need more than one whilst some legs may not need any.**

Step 5

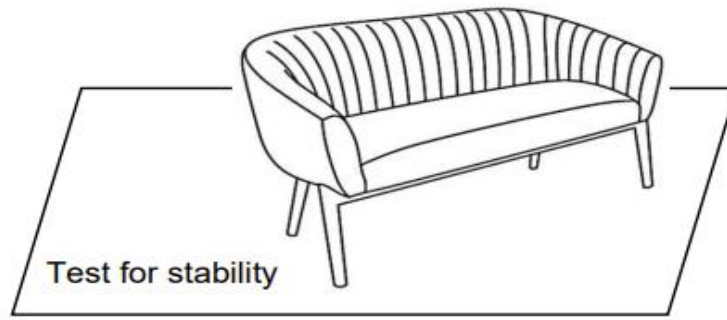

With help of an adult partner, stand the Loveseat up. Your Loveseat is ready for use.  
**This Loveseat can only be used on a flat, level surface.**