

60'

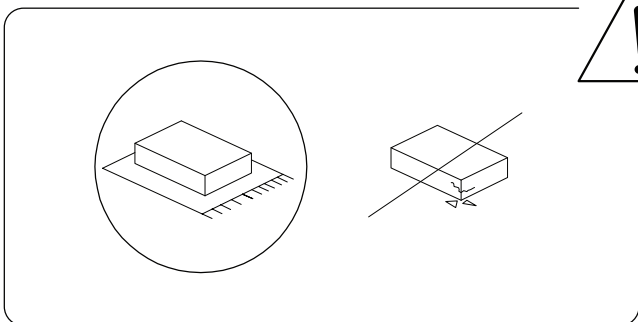

3

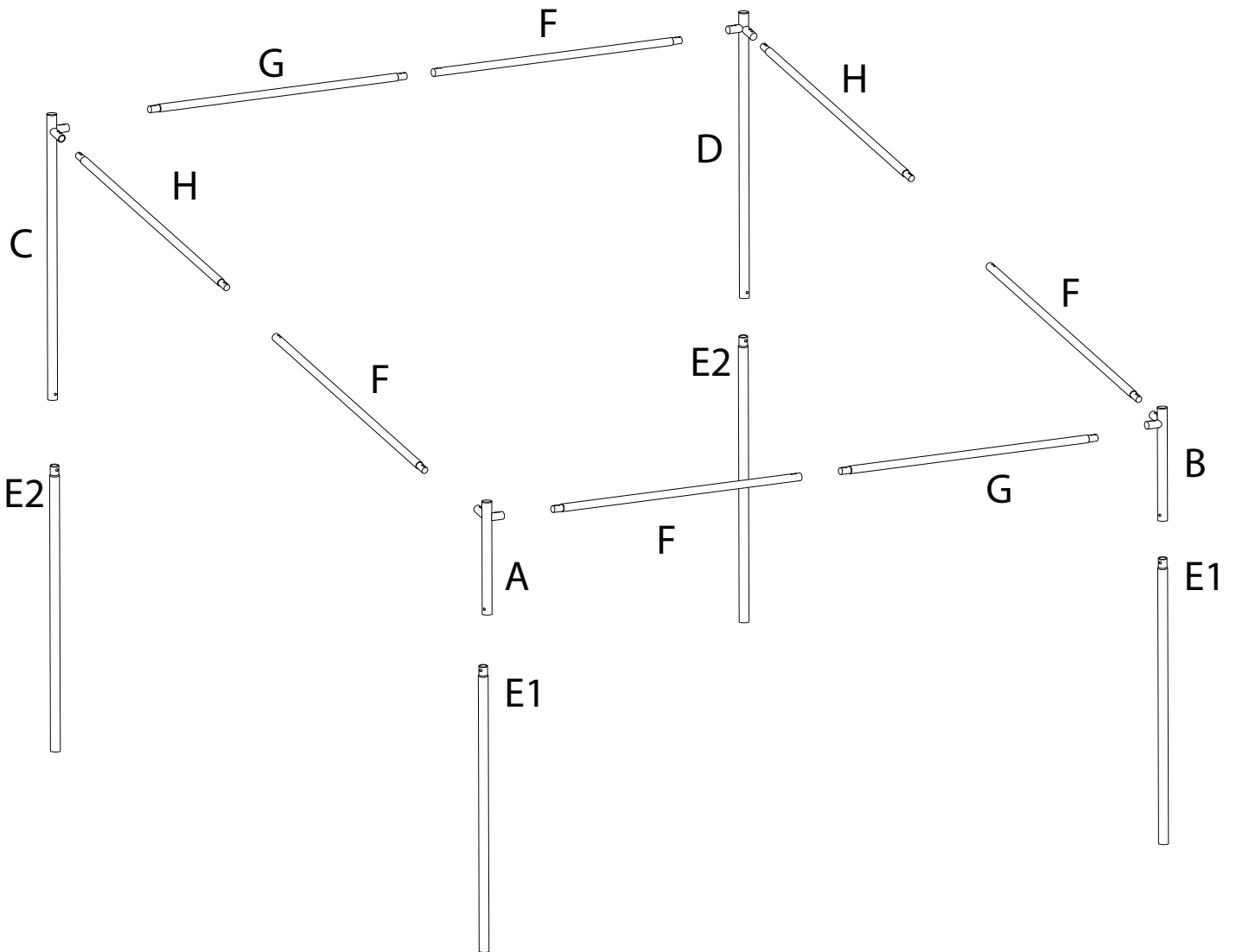
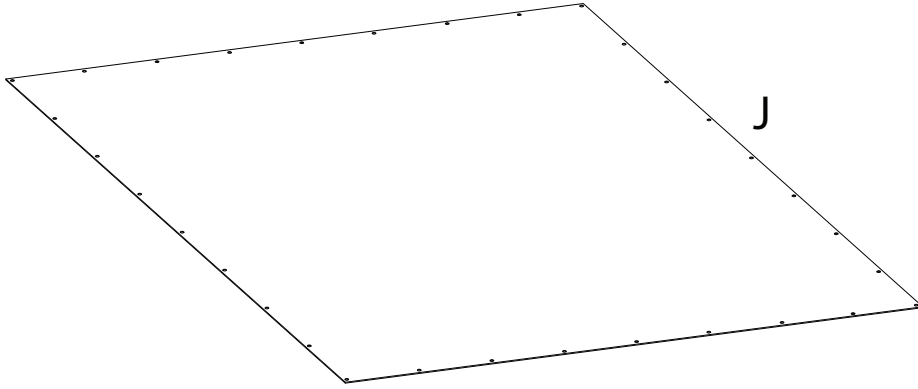

A



x 1

B

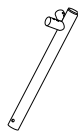

x 1

C

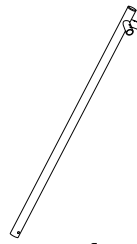

x 1

D

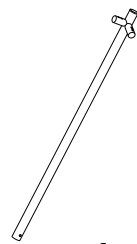

x 1

E1

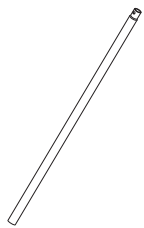

x 2

E2

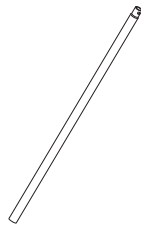

x 2

F

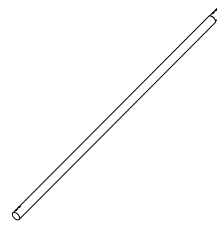

x 4

G

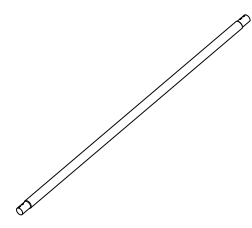

x 2

H

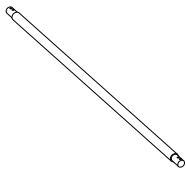

x 2

I

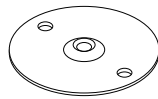

x 4

J

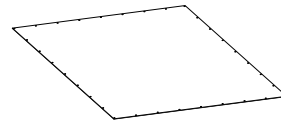

x 1

K



x 32

L

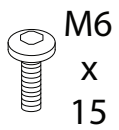

x 4

M

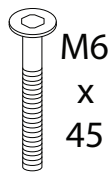

x 24

N

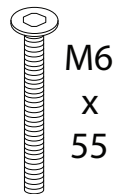

x 4

O

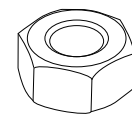

x 28

P



x 8

Q

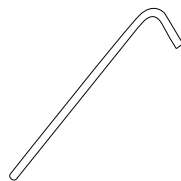

x 8

R

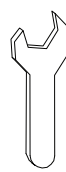





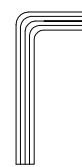



x 1

S

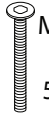

x 1

1

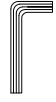

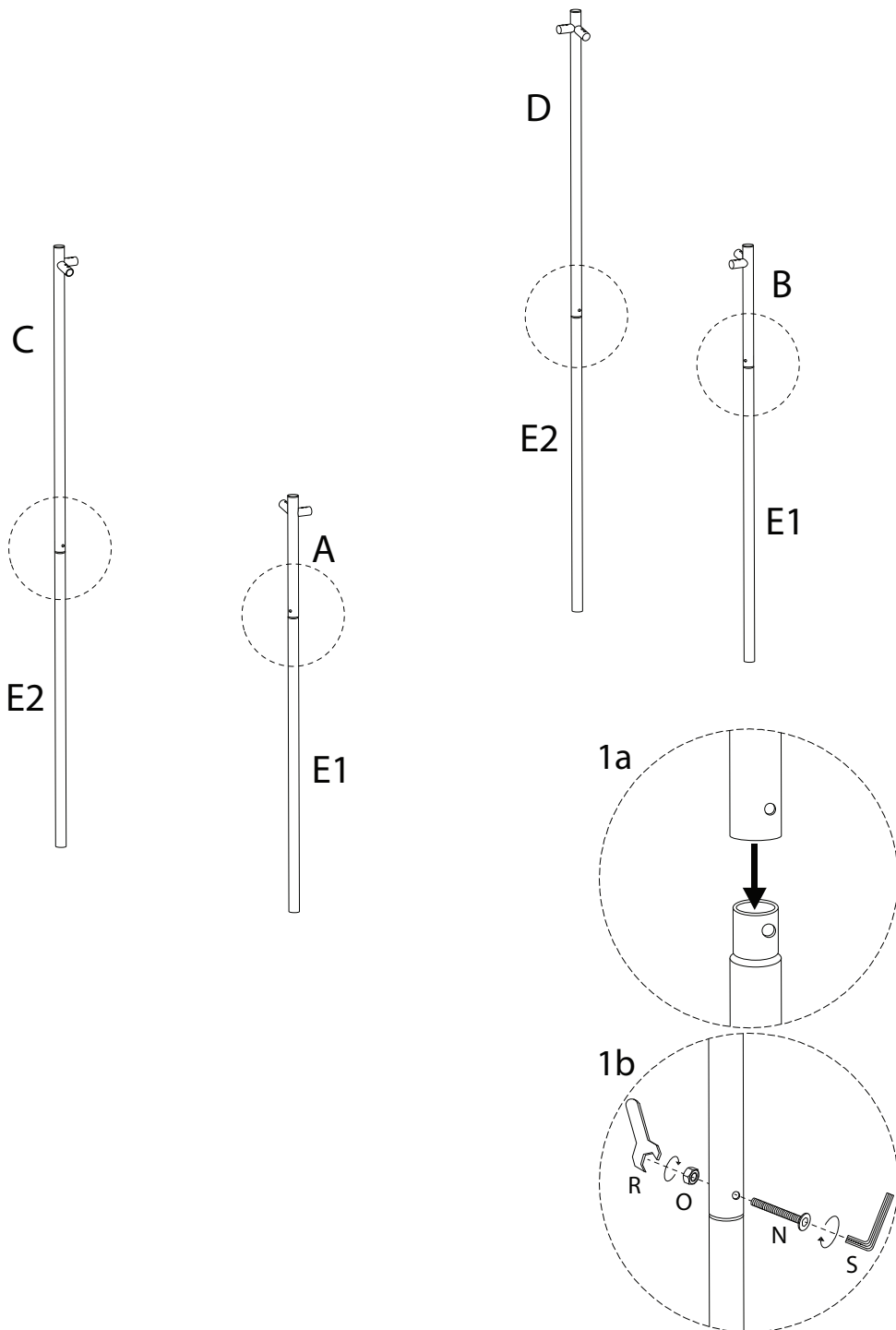

A  x 1	B  x 1	C  x 1	D  x 1	E1  x 2
E2  x 2	N  M6 x 55 x 4	O  x 4	R  x 1	S  x 1

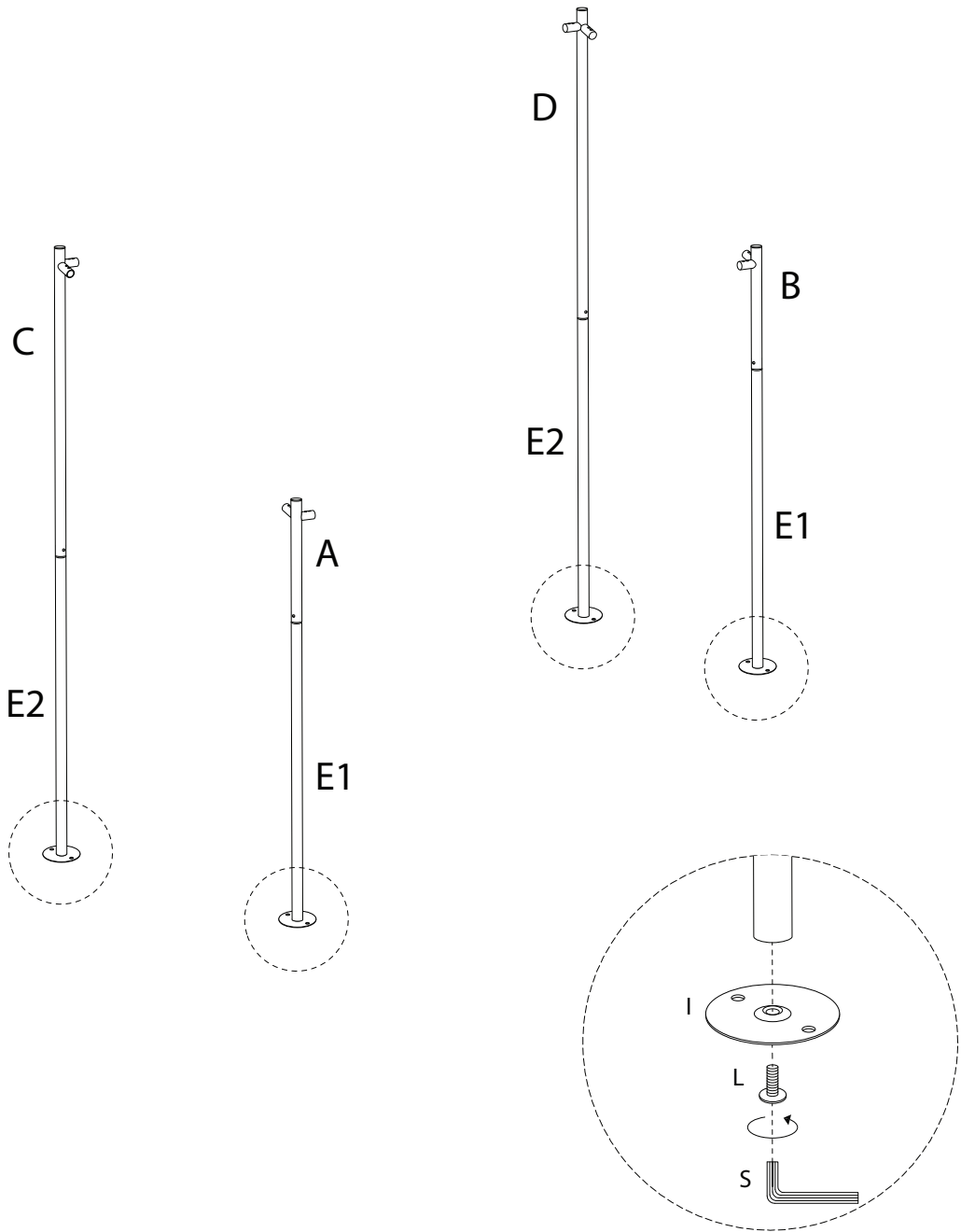
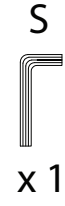
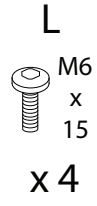
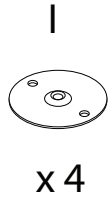

2



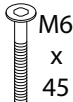

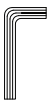
3

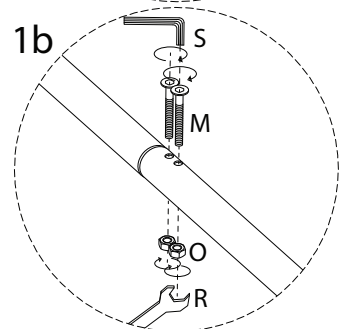
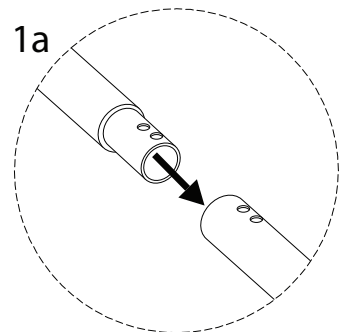
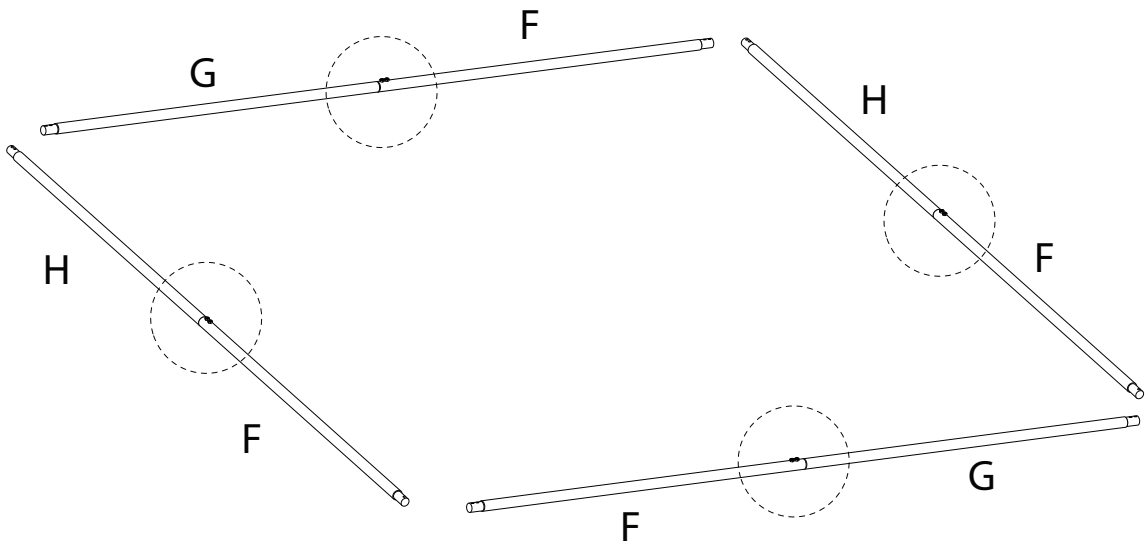
F	G	H	M	O	R	S
						
x4	x2	x2	x8	x8	x1	x1

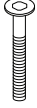

4

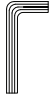
M  M6 x 45 x 16	O  x 16	R  x 1	S  x 1
------------------------------------------------------------------------------------------------------------------------	-------------------------------------------------------------------------------------------------------	--------------------------------------------------------------------------------------------------------	--------------------------------------------------------------------------------------------------------

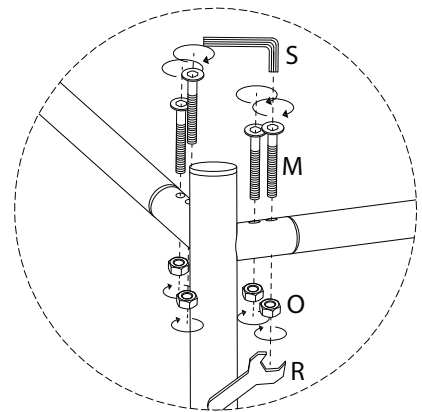
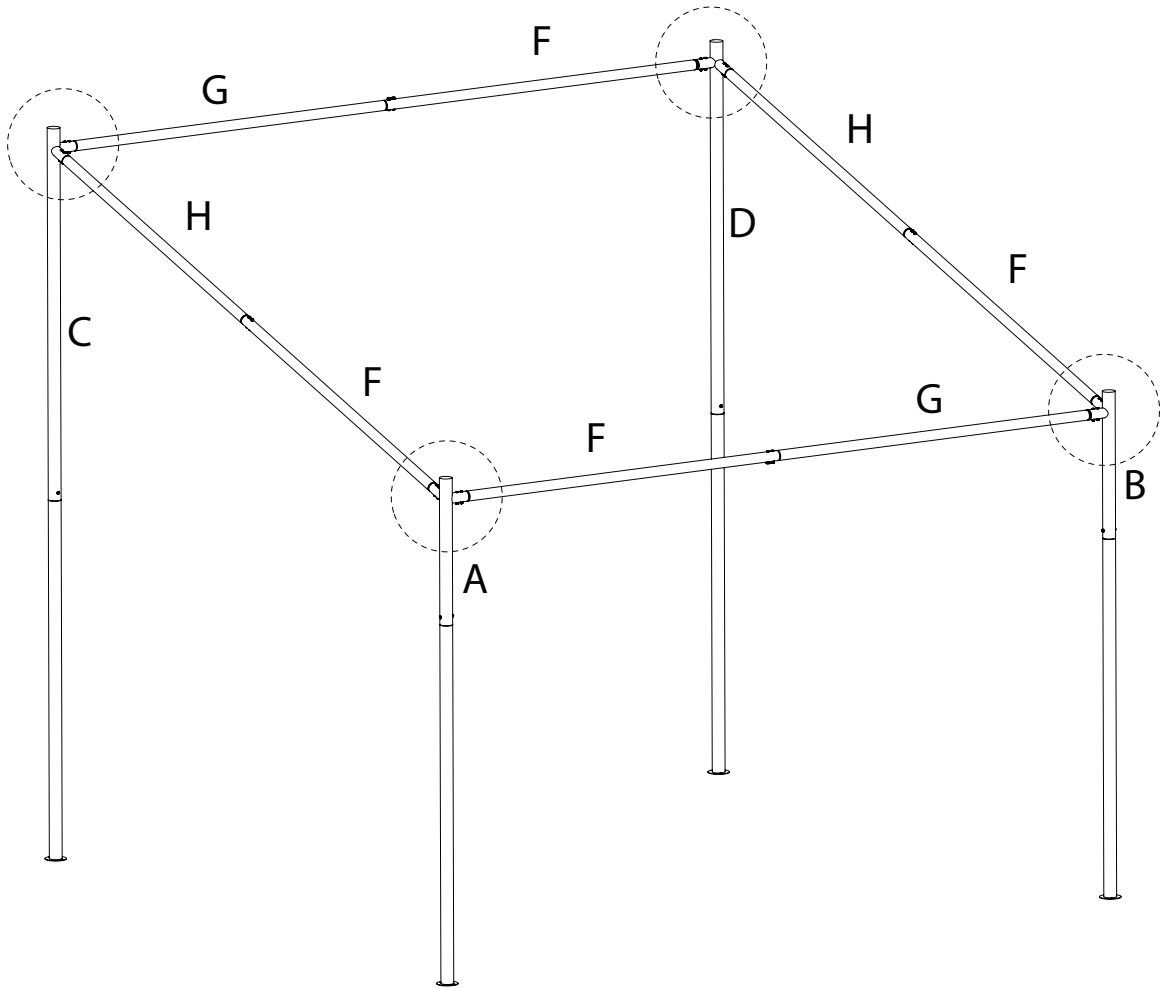

5

J

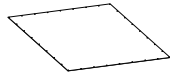

x 1

K



x 32

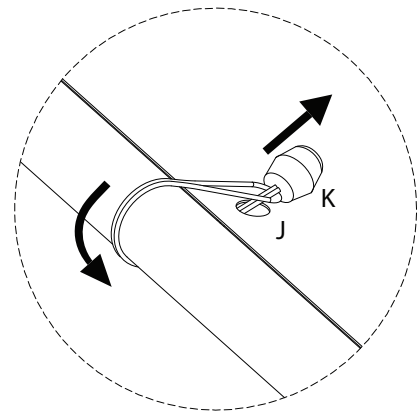
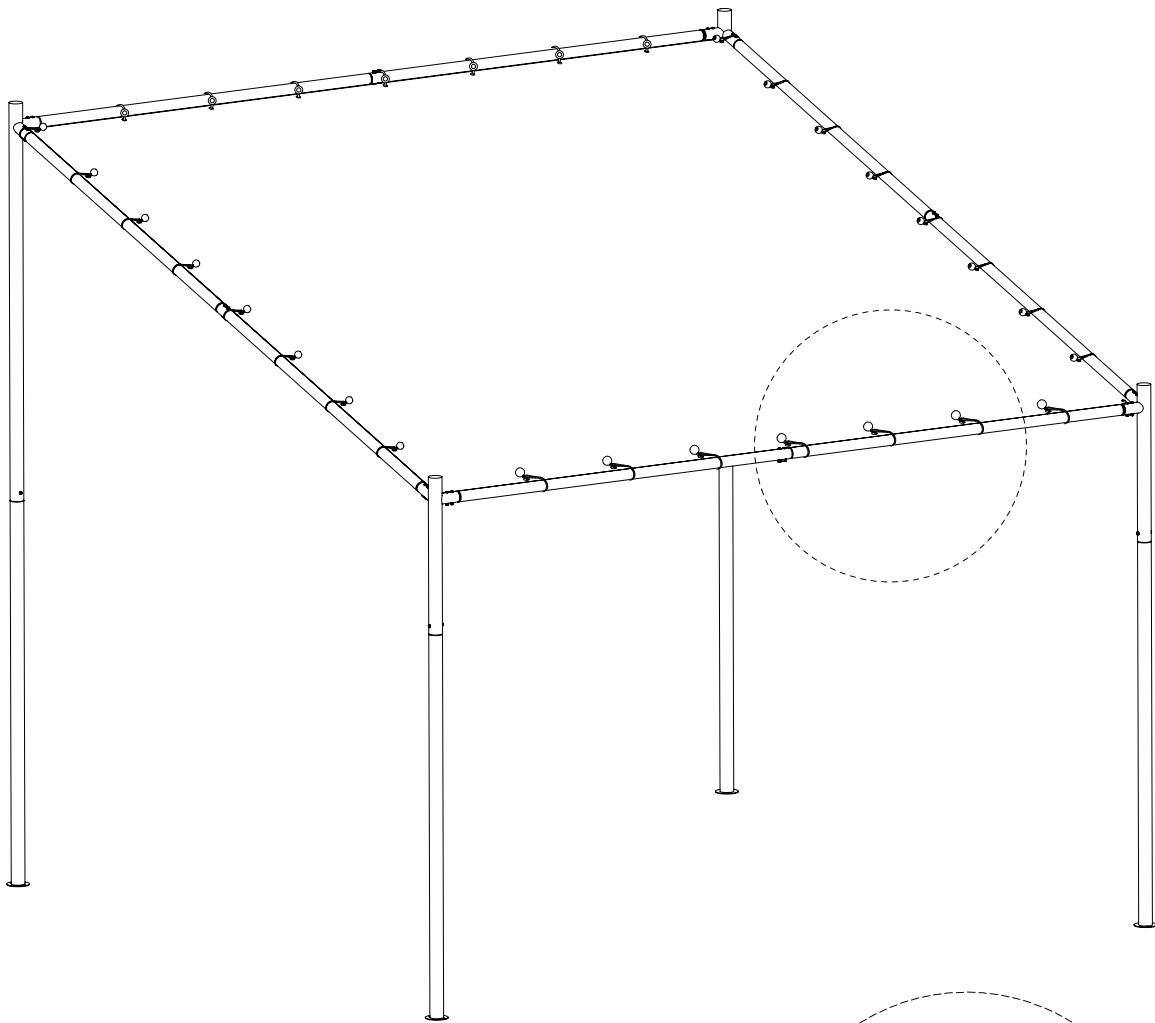

6

