

RDY05B

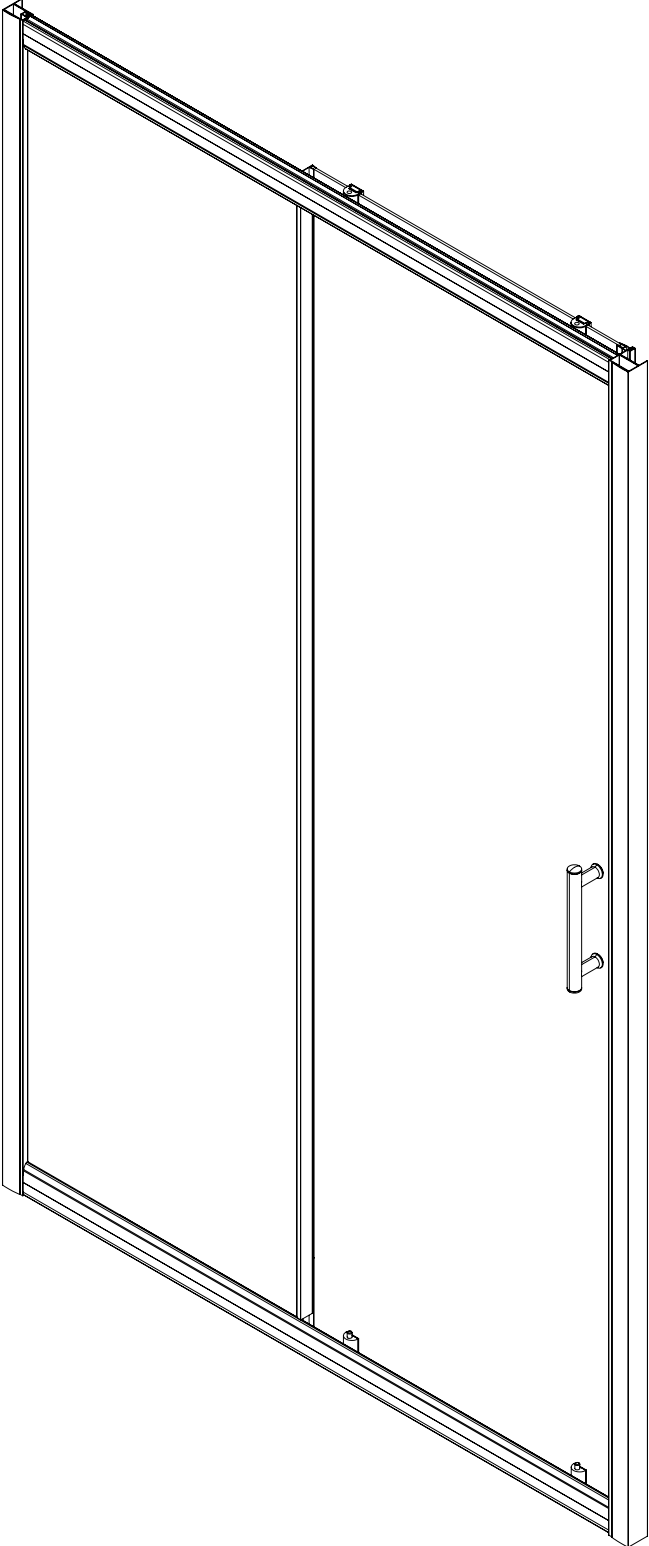

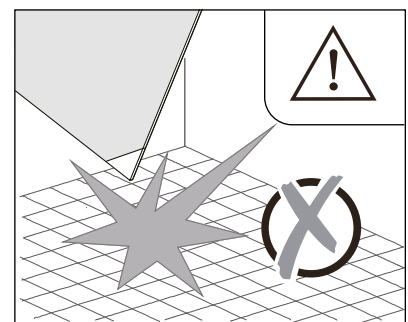

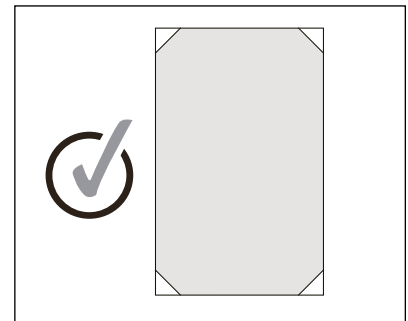

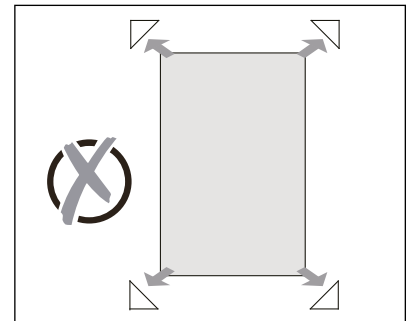
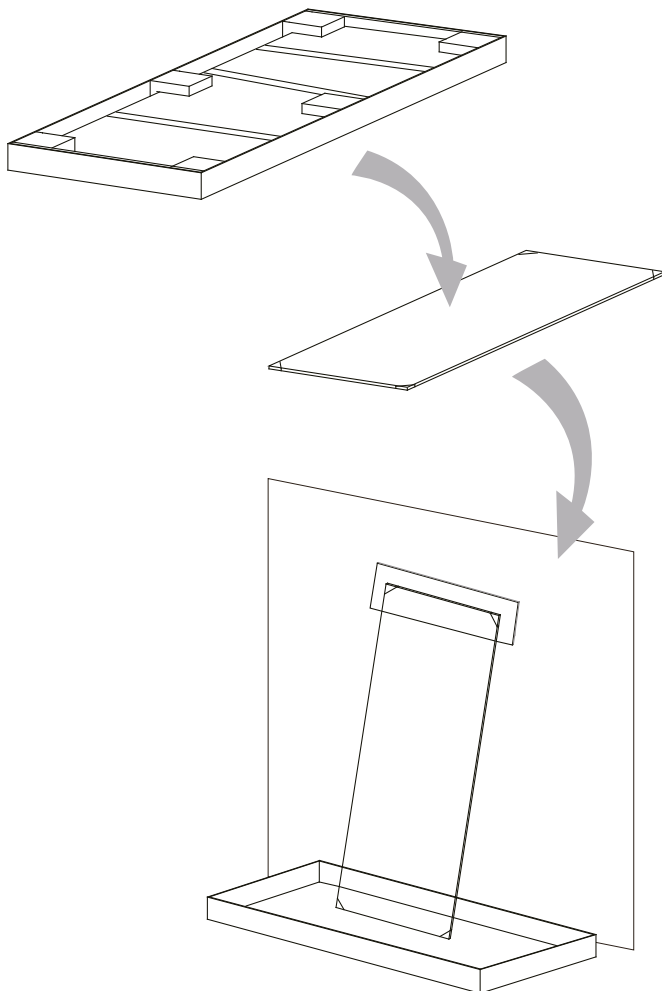
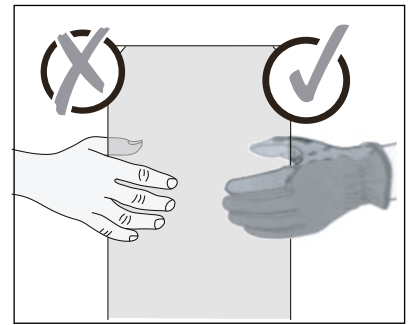
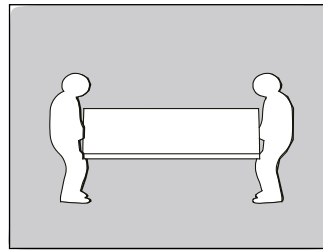
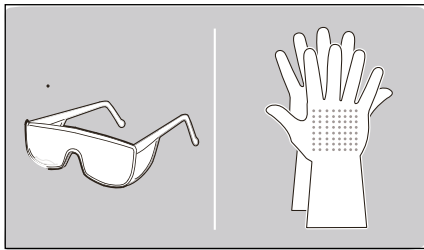
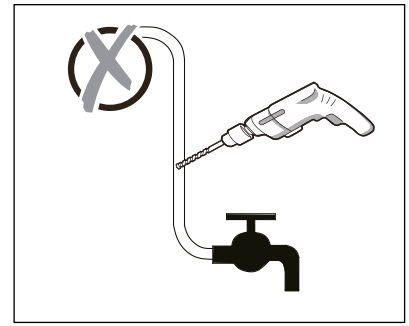
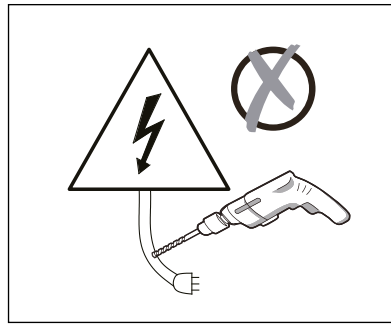
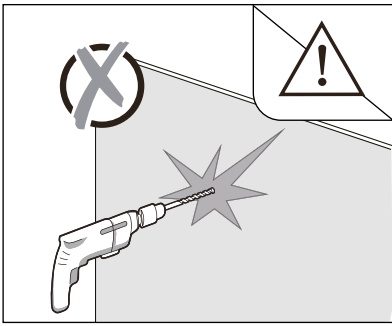
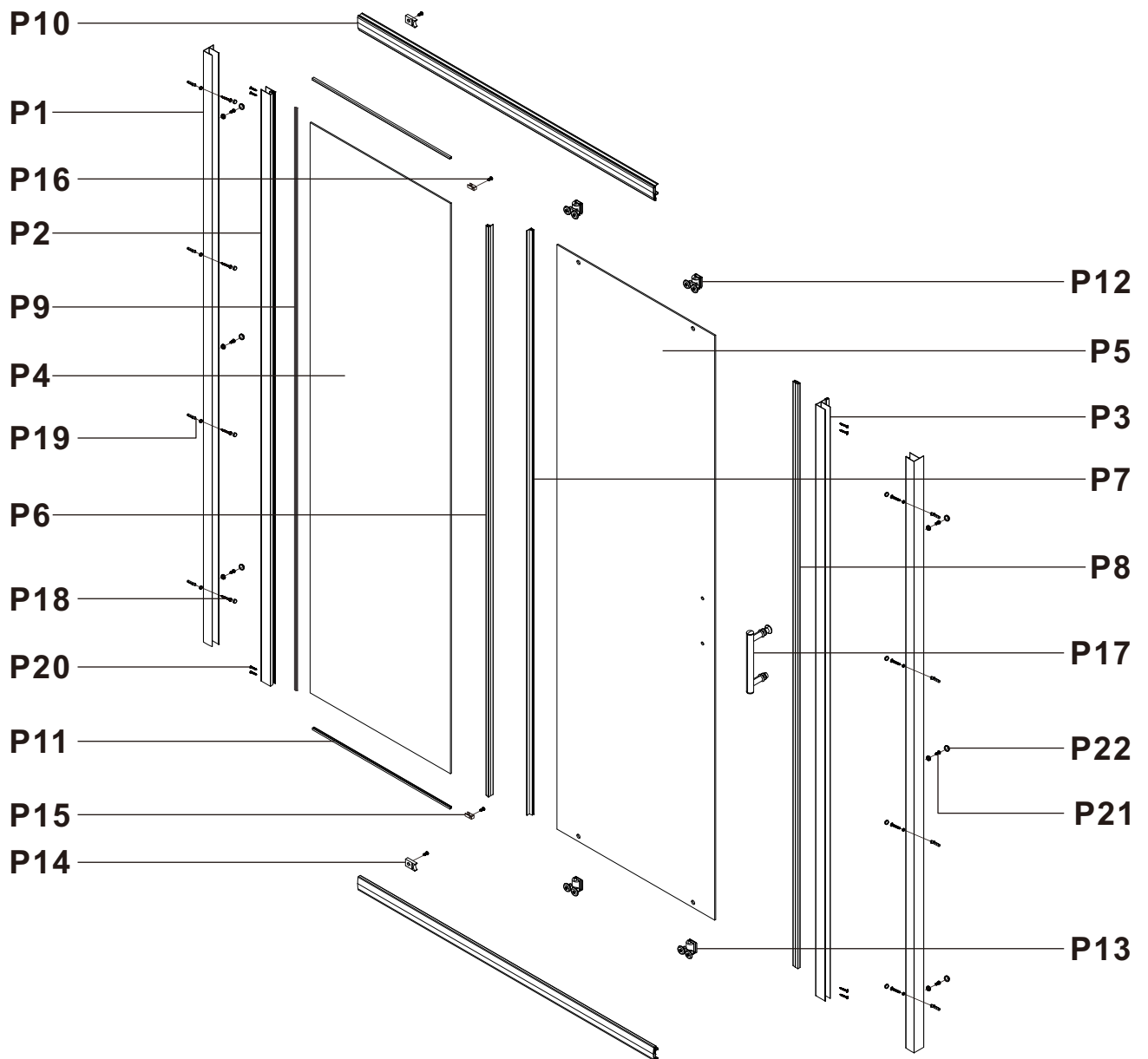
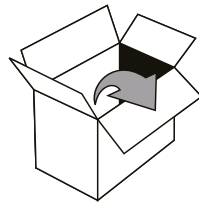

<b>P1</b>  X2	<b>P2</b>  X1	<b>P3</b>  X1	<b>P4</b>  X1
<b>P5</b>  X1	<b>P6</b>  X1	<b>P7</b>  X1	<b>P8</b>  X1
<b>P9</b>  X1	<b>P10</b>  X2	<b>P11</b>  X2	<b>P12</b>  X2
<b>P13</b>  X2	<b>P14</b>  X2	<b>P15</b>  X1	<b>P16</b> ST4x11MM  X2
<b>P17</b>  X1	<b>P18</b> ST3.5x30MM  X8	<b>P19</b>  X8	<b>P20</b> ST3.9x20MM  X8
<b>P21</b> ST4x10MM  X8	<b>P22</b>  X14		

 Ø 6mm	
 ⊕ PH2	
 Ø 3mm	

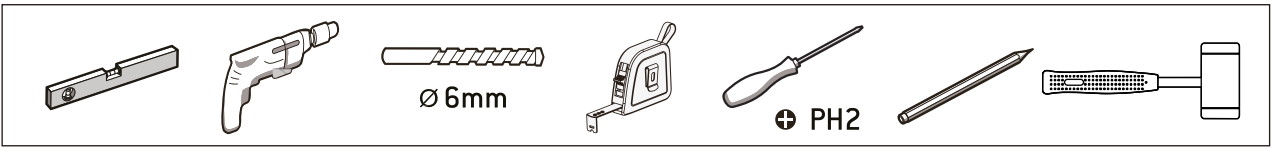

5

**1**

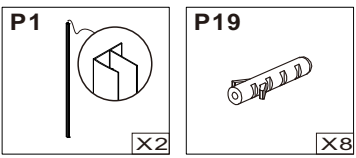
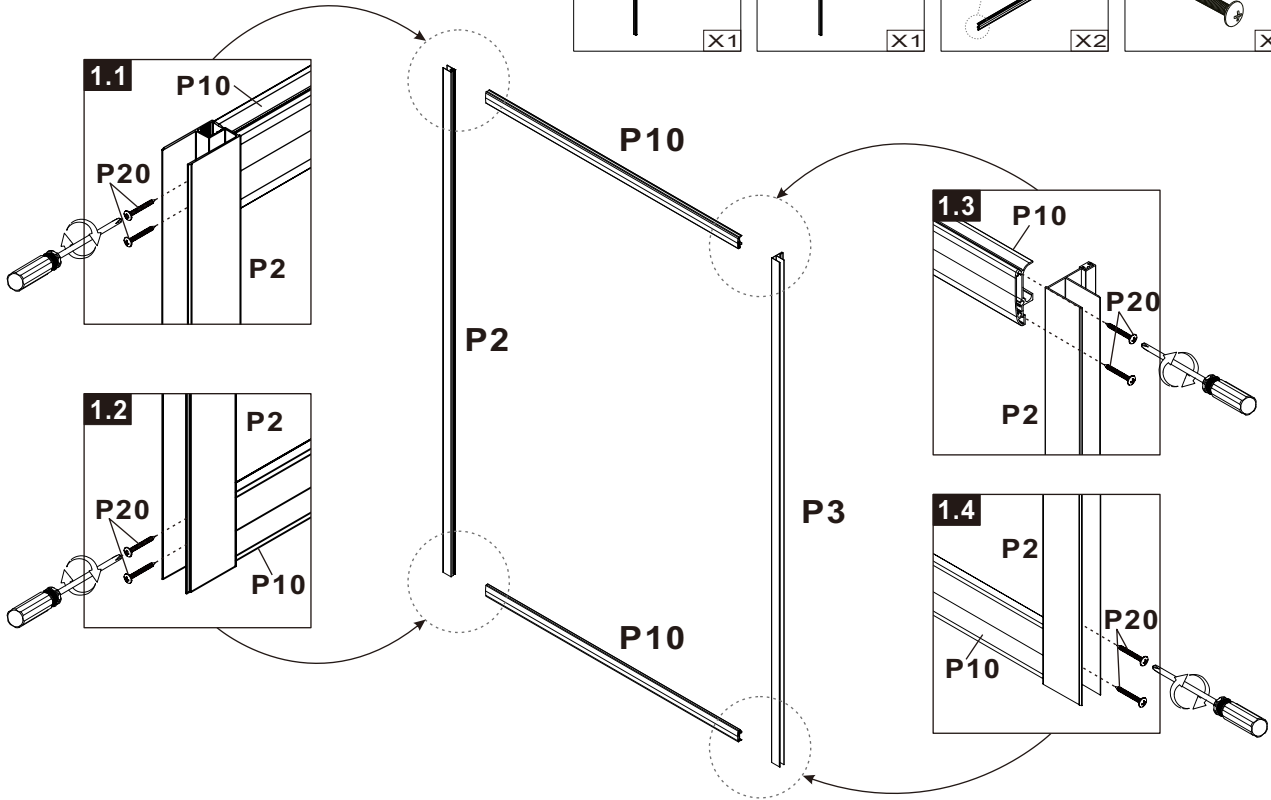
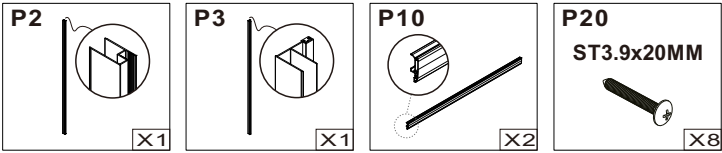

**2**

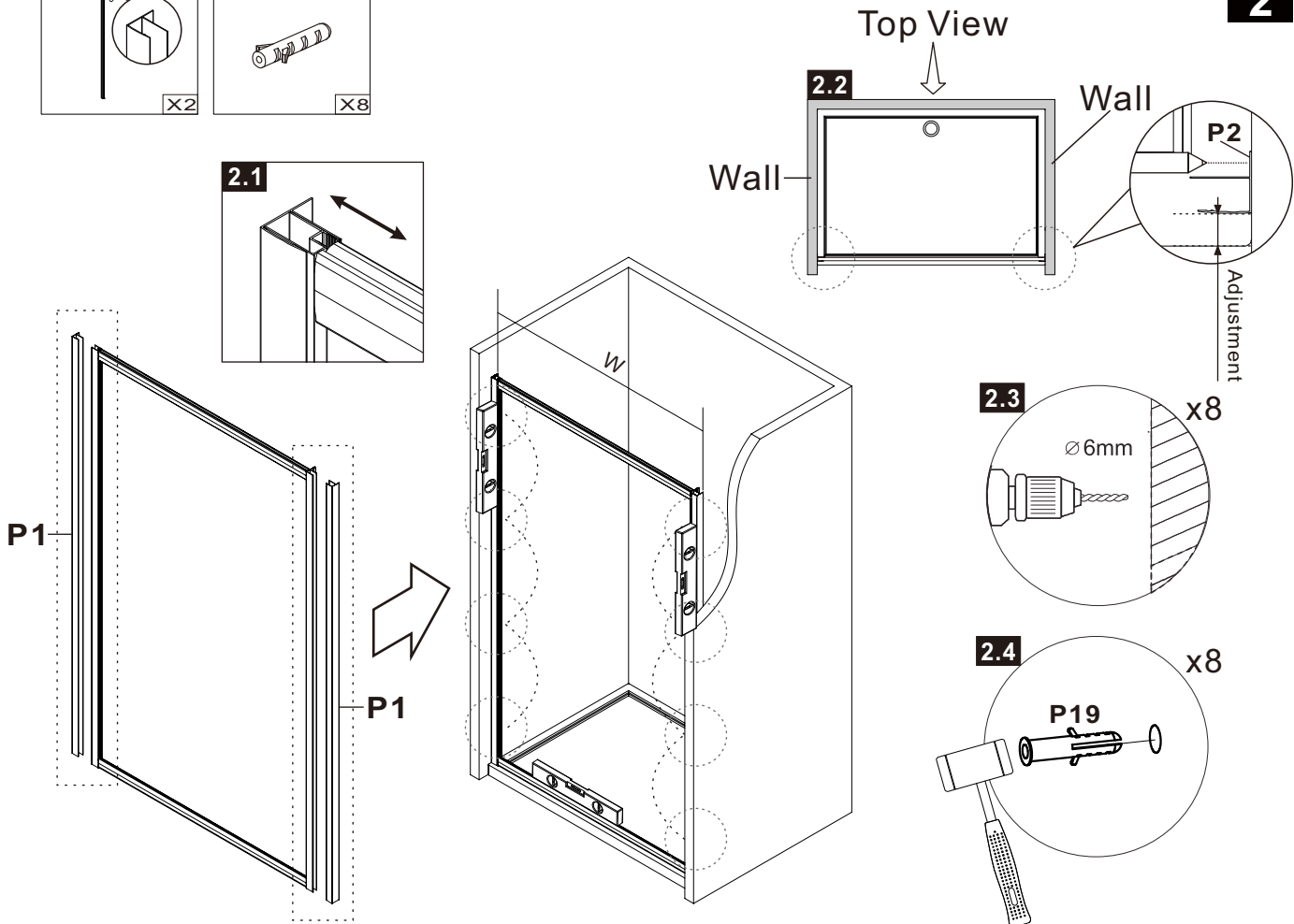

6



⊕ PH2

**3**

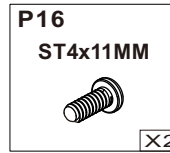
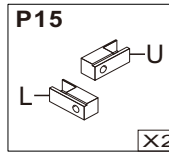
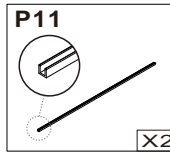
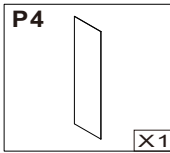
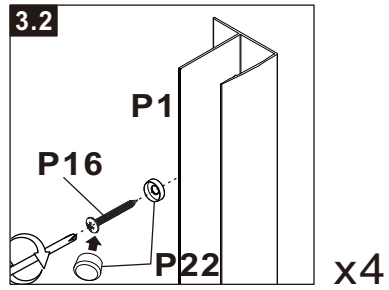
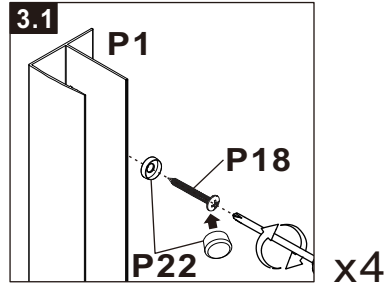
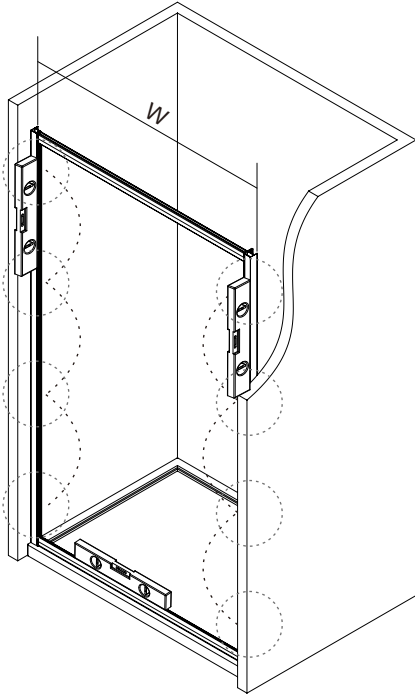
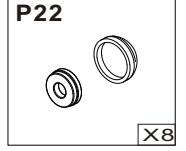

**4**

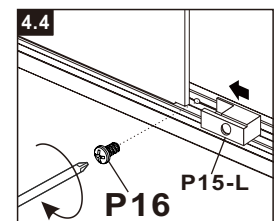
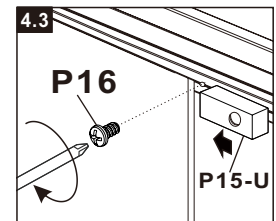
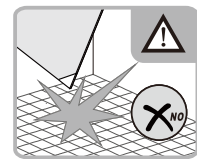
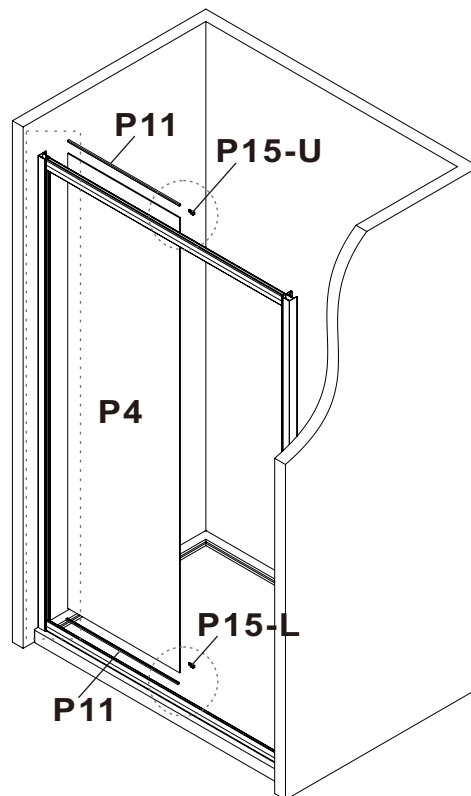
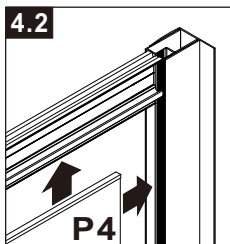
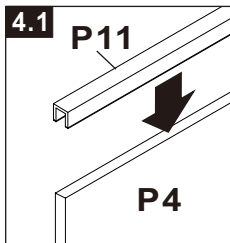



PH2

5

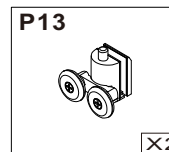
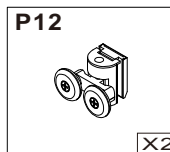
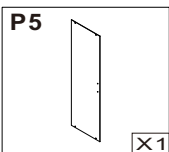
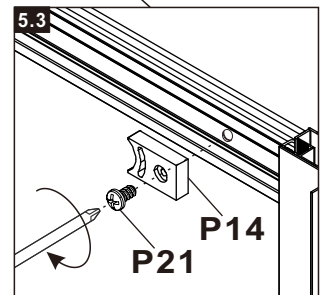
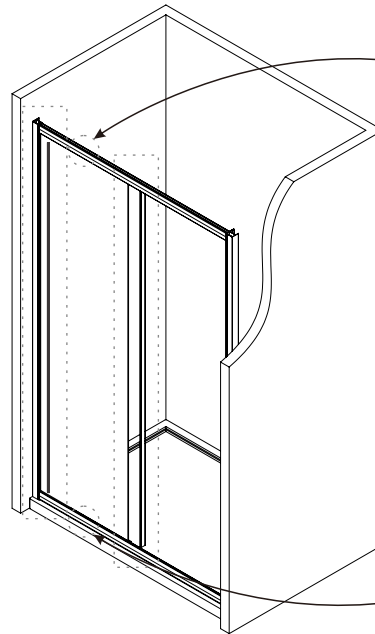
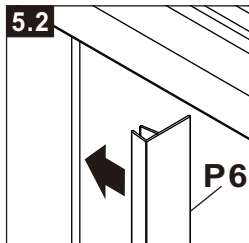
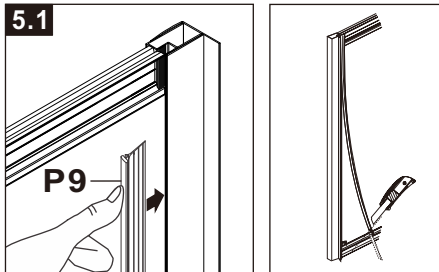
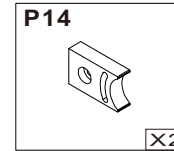
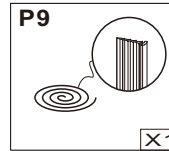
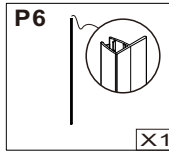

6

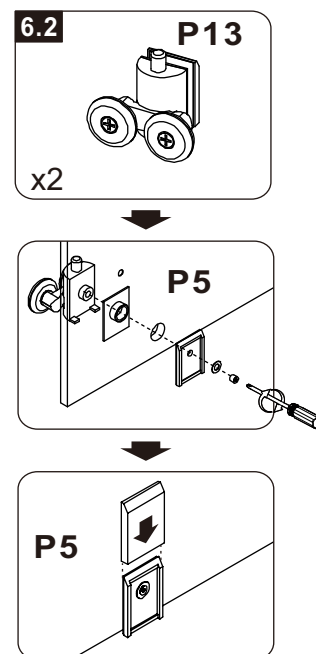
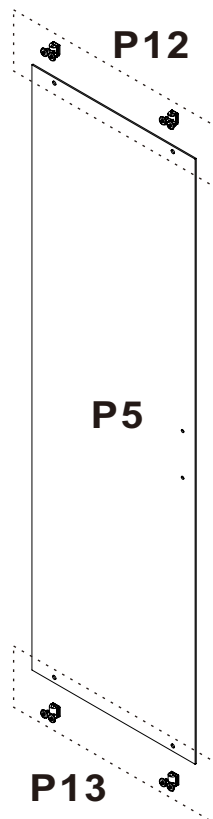
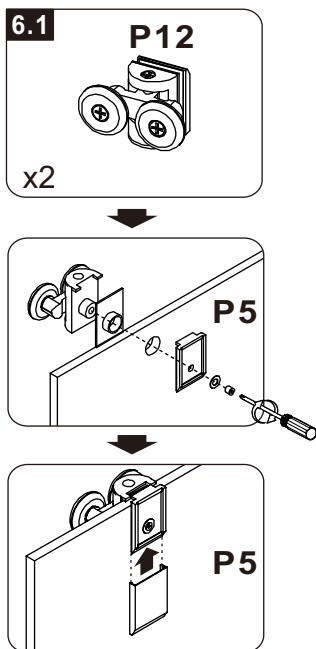
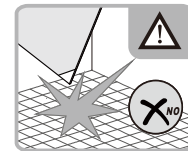



7

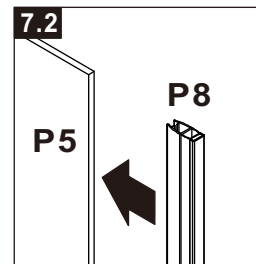
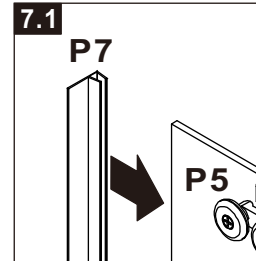
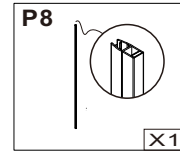
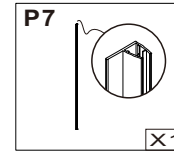
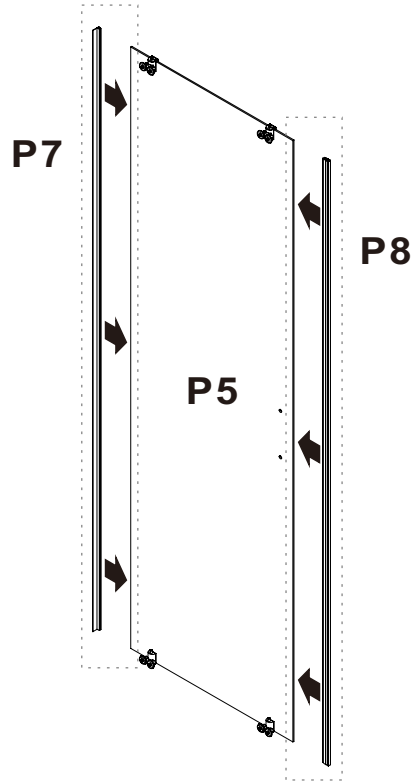
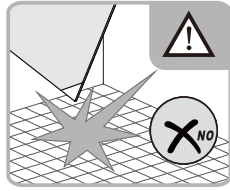

8

Bottom

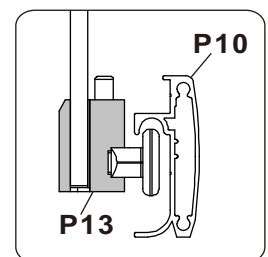
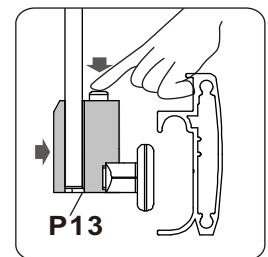
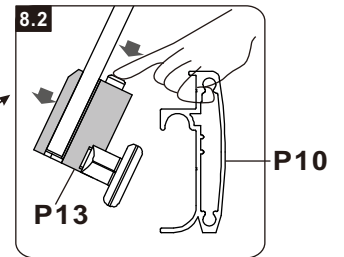
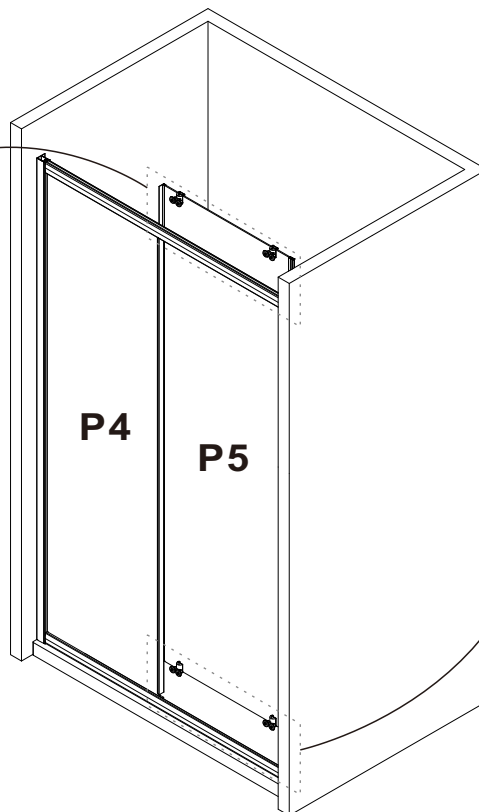
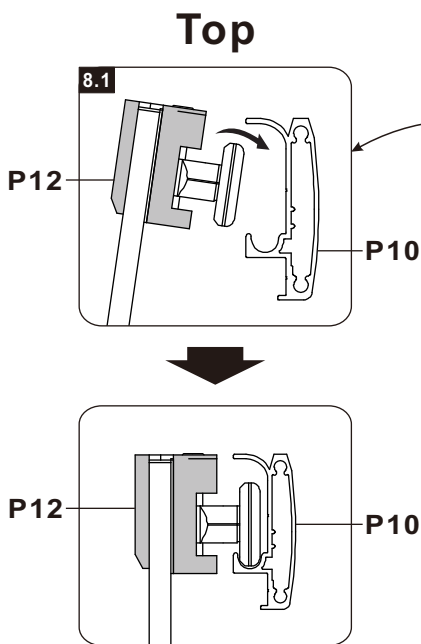



Ø3mm



PH2

9

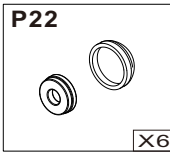
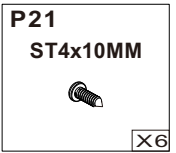
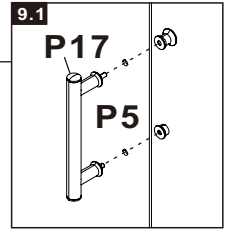
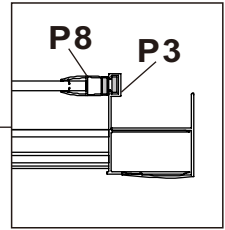
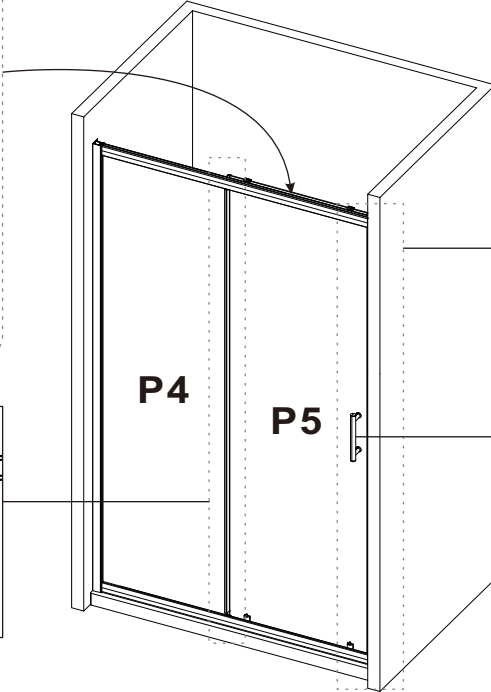
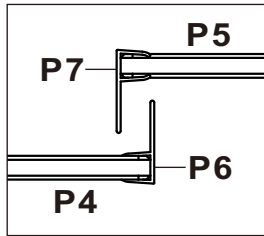
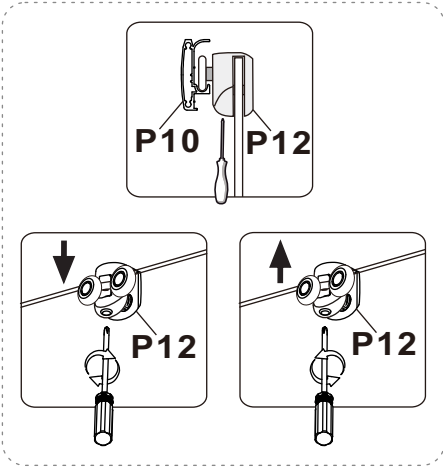
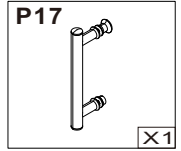

10

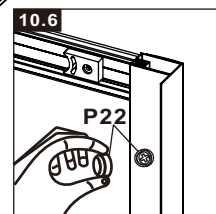
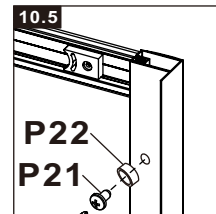
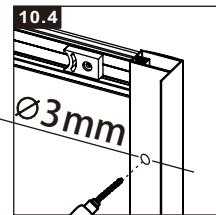
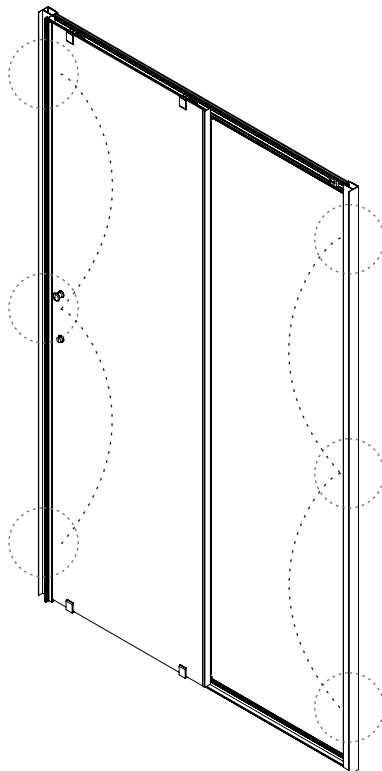
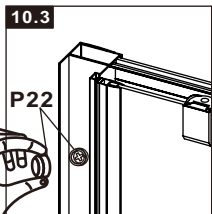
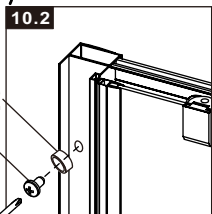
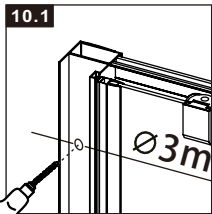



**11**

