

# Assembly Instructions

**Caution : You must read this before you proceed**

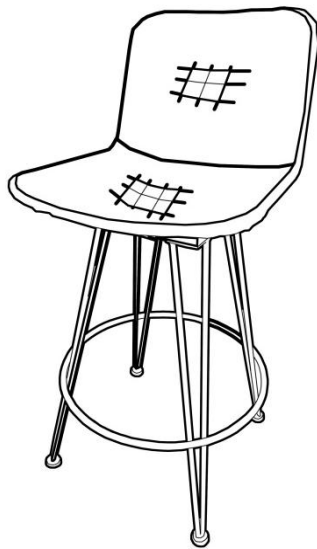

## Barstool



### Parts List

Label	Picture	Description	QTY
A	A line drawing of the seat part of the barstool, showing the grid pattern on the top and bottom surfaces.	Seat	1
B	A line drawing of the leg frame part of the barstool, showing the four legs, the circular base ring, and the central support post.	Leg Frame	1

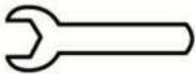
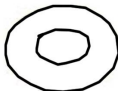
# Hardware

Label	Picture	Description	QTY
①		Nut	5
②		Spanner	1
③		Washer	5
④		Spring Washer	5

# Assembly Preparation

Before Beginning Assembly:

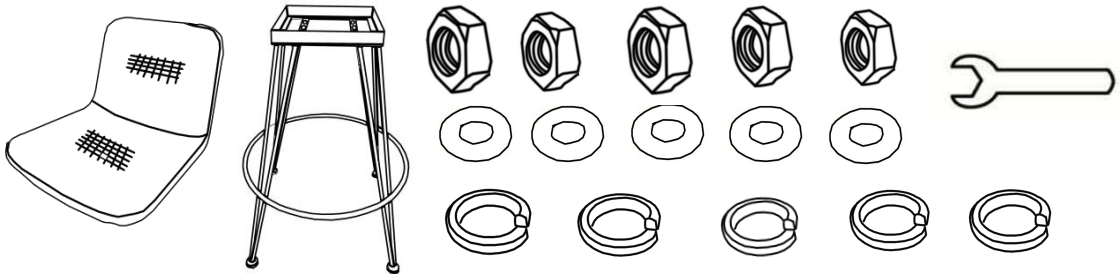

- Read instructions, cover to cover-



- Have 2 adults on hand for assembly-



- Do not assemble on flooring or carpet-



- Assemble on a clean non-marring surface (packing foam)-



- Save all packaging until finished-

## Assembly Steps

### Overview

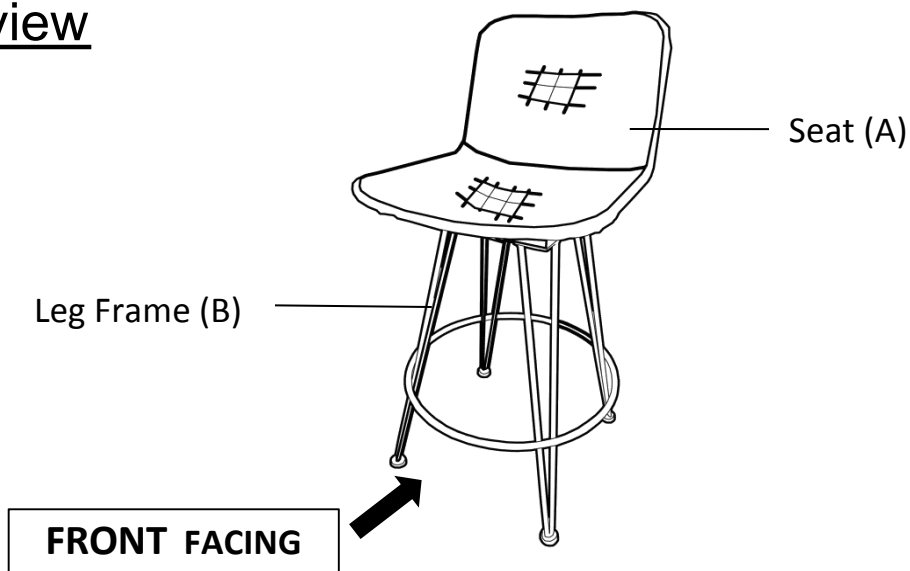

This Barstool has multiple parts and may require up to some 20 minutes to assemble. To give you an overview of the Barstool parts, the above picture is to help you put the various parts into perspective. Please read through the instructions below to familiarise yourself with the parts and steps before assembly.

### Step 1

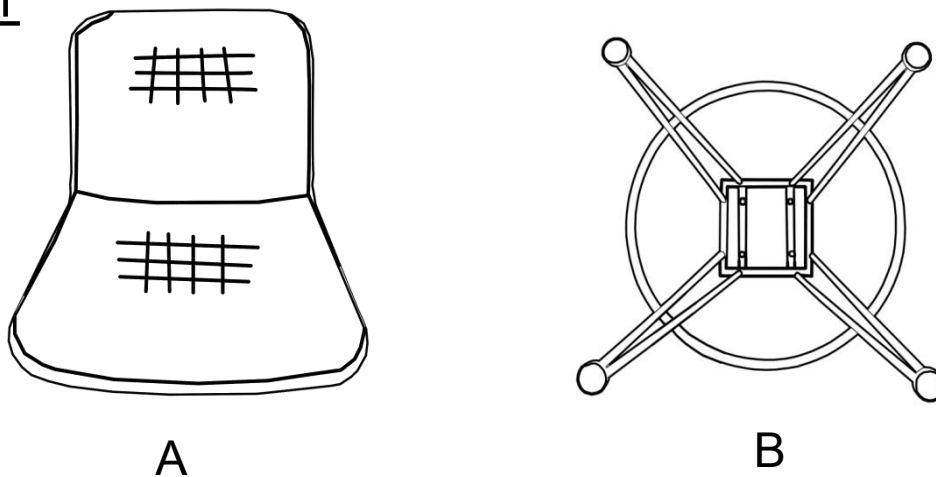

Open the carton and place all the parts on a clean, non-marring surface.

## Step 2

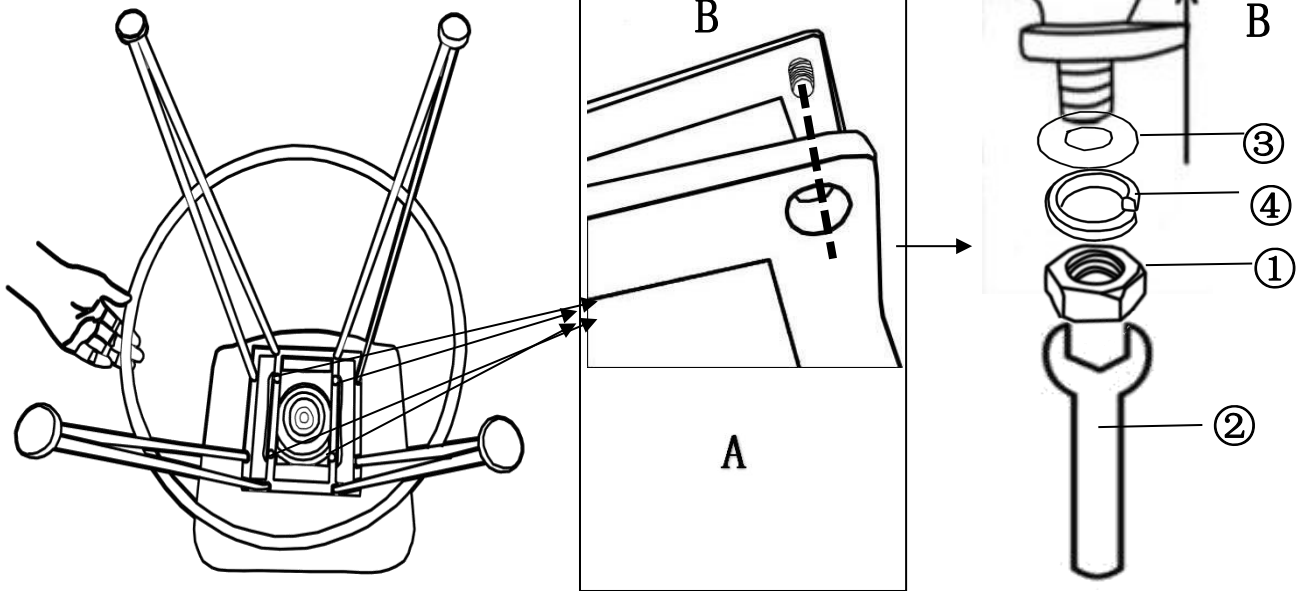

Place the Seat(A) facedown, then align the Leg Frame(B).  
Attach the Leg Frame(B) to Seat(A) using Nuts(①), Spring Washers(④) and Washers(③) with Spanner(②).  
**Do not fully tighten the Nuts.**

## Step 3

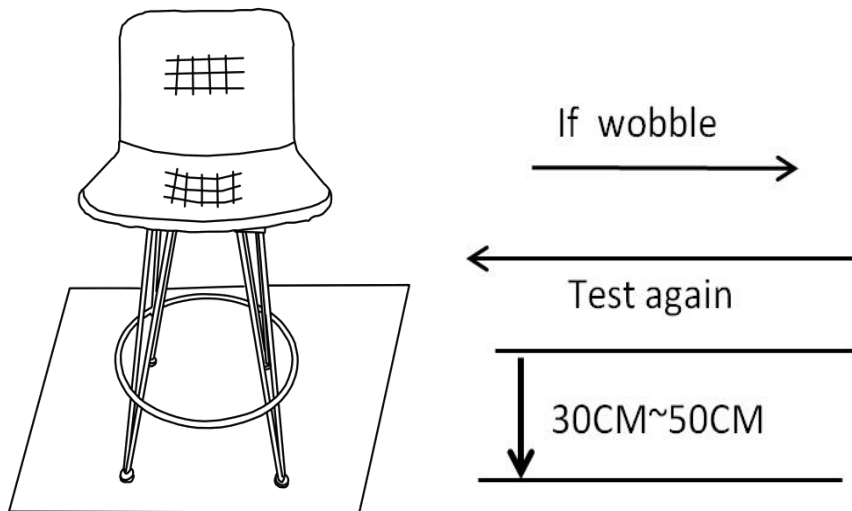





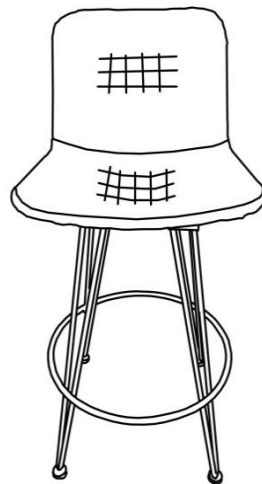















Place the Barstool on a LEVEL SURFACE to see if it wobbles.  
If it wobbles, lift the Barstool some 30cm to 50cm high from the ground.  
Keep your feet and toes well away from the drop zone.  
Drop the Barstool freely and vertically with the four legs, hitting the ground, at the same time.  
This Drop Test will help to ensure that all the Nuts and gaps to reach full alignment status.  
Test again for evenness on a LEVEL SURFACE.  
If no wobbles are found, lay down the Barstool and proceed to tighten all the Nuts.  
**When tightening the Nuts, tighten sequentially.**  
**DO NOT tighten any Nut fully and then move on towards the next one.**  
This could cause the frame to warp.  
If there is still wobbles, loosen the Nuts and execute this same drop test.  
**If the Barstool is not stable, it could lead to damage to the product.**

## Step 4



Your Barstool is ready for use.  
**This Barstool can only be used on a flat, level surface.**

## Care & Maintenance

-   ● Do not put hot items directly on furniture surface
  -   ● Do not clean furniture with harsh cleansers or polish.
  -   ● To obtain the longest lifespan of your outdoor products, minimizing exposure to direct sunlight is recommended.
  -   ● Children should not climb or jump on the furniture.
  -   ● Do not write on furniture without a padded barrier to protect the surface.
  -   ● To obtain the longest lifespan of your outdoor products, avoid extended and direct sunlight. Whenever possible cover the furnishings.
  -   ● For outdoor use only.
  -   ● Stains may be removed with mild soap solution and damp cloth.
  -   ● Keep away from sources of ignition.
- 
-   ● Dust and pick-up spills using a clean, non-colored, lint-free cloth .

### What is Proposition 65?

Proposition 65 is a California law that requires warning labels on products that may contain one of more than 800-plus chemicals or ingredients that the California Office of Environmental Health Hazard Assessment (OEHHA) has deemed to cause cancer or other reproductive toxicity. Chemicals and elements on this list include wood dust, brass, and other everyday substances, which can be found in very common household items, such as: lamps, tableware, jewelry, crystal glasses, electric cords, beauty products, automobiles, and furniture.

### Why Did I Find a Proposition 65 Warning on My Home Goods Product?

We include Proposition 65 warnings on all of our products because there is always a chance that one of the 800-plus common chemicals and ingredients listed under this law could potentially be on our furniture or packing materials. We risk large fines under this law, if we don't include this warning.

### Should I worry?

We realize you may be worried finding this warning on our products, but we want to reassure you that the hazardous exposure limits for any of these chemicals have never been found on furniture products that we've shipped to our customers. Additionally, this warning label is very common and can be found on almost every piece of furniture sold in the state of California.

### Just How Common Are Proposition 65 Warnings?

Proposition 65 warnings have become so common in California that it is hard to take a trip to a local bank, grocery store, or restaurant without finding at least one warning. In fact, even the Disney Land Resort has a Proposition 65 warning:

