

ASSEMBLY INSTRUCTIONS

DJ0855-240CM

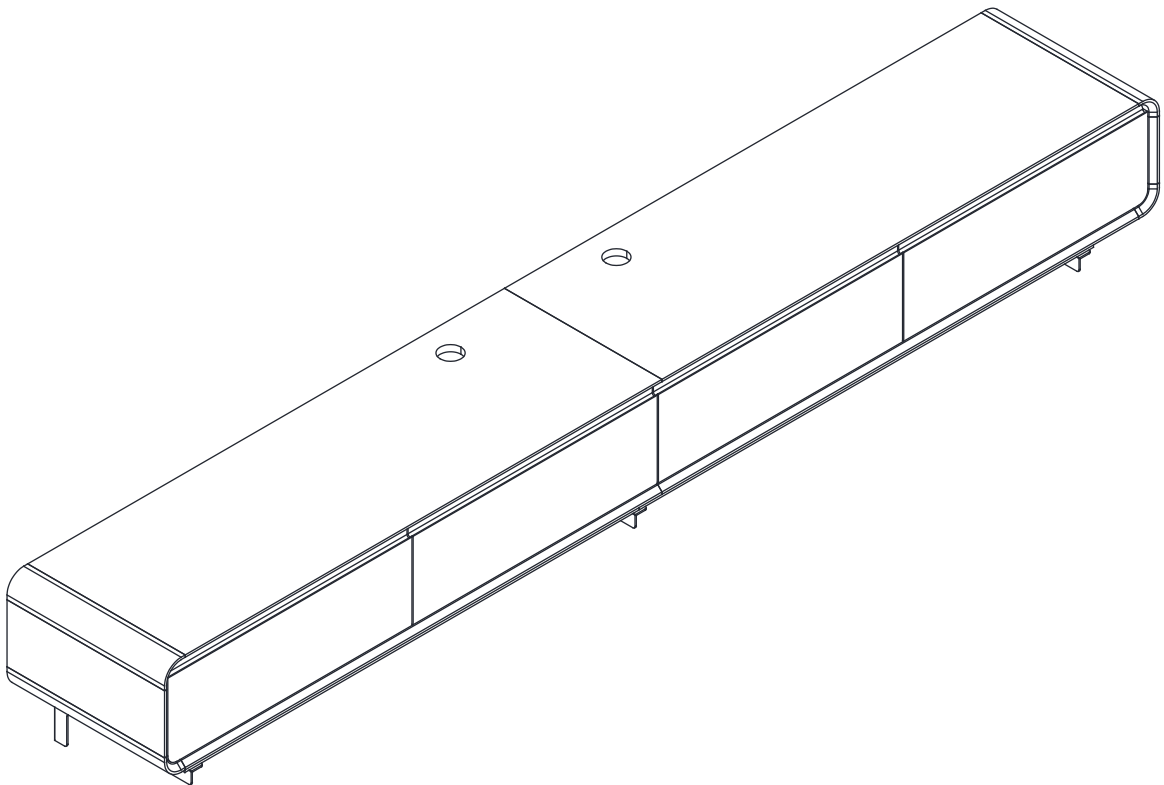

⚠ SAFETY TIPS:

Static charge may cause dust on foam-clean with a dry or damp cloth. Small foam strands may be present-handle gently and dispose of properly. Do not burn or incinerate. Check local recycling guideline.

Installation Video QR



DJ0855

<https://vimeo.com/1058057735>

Have an assembly question or need a replacement part?
Please contact with our customer service.

⚠ SAFETY TIPS

Static charge may cause dust on foam-clean with a dry or damp cloth.

Small foam strands may be present-handle gently and dispose of properly.

Do not burn or incinerate. Check local recycling guideline.

⚠ CONSEILS DE Sécurité

L'électricité statique peut attirer la poussière sur la mousse - nettoyer avec un chiffon sec ou humide.

De petits morceaux de mousse peuvent être présents - manipuler avec précaution et jeter correctement.

Ne pas brûler ni incinérer. Vérifier les directives de recyclage locales.

Have an assembly question or need a replacement part?
Please contact with our customer service.

Vous avez une question sur le montage ou besoin d'une pièce de rechange ?
Veuillez contacter notre service client.

WARNINGS

Important reminder:

Please sort and check all accessories before assembly.
Place the product on an empty cardboard box or on carpet to prevent scratches.

- ⚠ Please use proper tools for assembly. Using an electric screwdriver can accelerate the assembly speed, but please do not overtighten the screws.
- ⚠ Please follow the assembly steps and do not skip any of them.
- ⚠ If possible, please find a partner to help you with assembly, which can accelerate assembly.
- ⚠ Keep all small parts of this product away from children. They may cause serious injury.
- ⚠ We hope you can retighten the screws 2 weeks after assembly, and check the tightening procedure of the screws every 3 months.
If you meet any difficulty, our friendly customer team are always ready to help you.

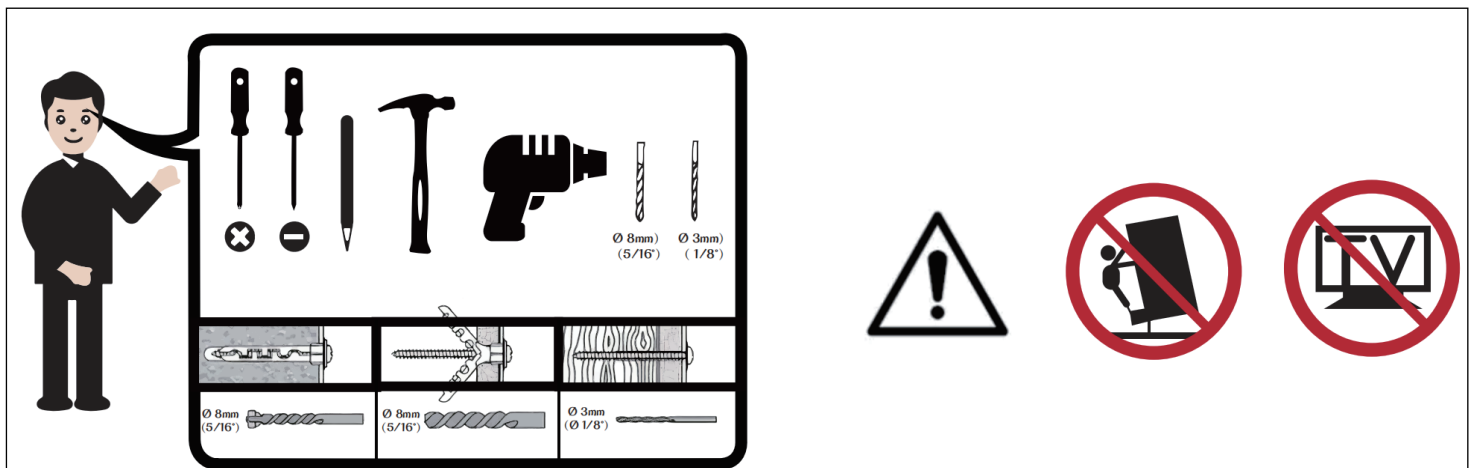

WARNING — Tip-Over / Crush Hazard

Furniture can tip over and cause serious crushing injuries. If an anti-tip kit is provided, install it after assembly and use it as instructed. Do not modify the structure of this product. Use only as intended and ensure all fasteners are fully tightened. The manufacturer is not responsible for damage or injury caused by unauthorized modifications or improper assembly.
Peel off film before use

AVERTISSEMENTS

Rappel important :

Veillez trier et vérifier tous les accessoires avant le montage.
Placez le produit sur un carton vide ou sur une moquette pour éviter les rayures.

- ⚠ Veillez utiliser les outils appropriés pour le montage. L'utilisation d'une visseuse électrique peut accélérer le montage, mais veuillez ne pas trop serrer les vis.
- ⚠ Veillez suivre les étapes de montage et ne pas en sauter aucune.
- ⚠ Si possible, veuillez trouver un partenaire pour vous aider lors du montage, ce qui peut accélérer le processus.
- ⚠ Gardez toutes les petites pièces de ce produit hors de portée des enfants. Elles pourraient causer des blessures graves.
- ⚠ Nous vous recommandons de revisser les vis 2 semaines après le montage, et de vérifier le serrage des vis tous les 3 mois.
Si vous rencontrez des difficultés, notre aimable équipe du service client est toujours prête à vous aider.

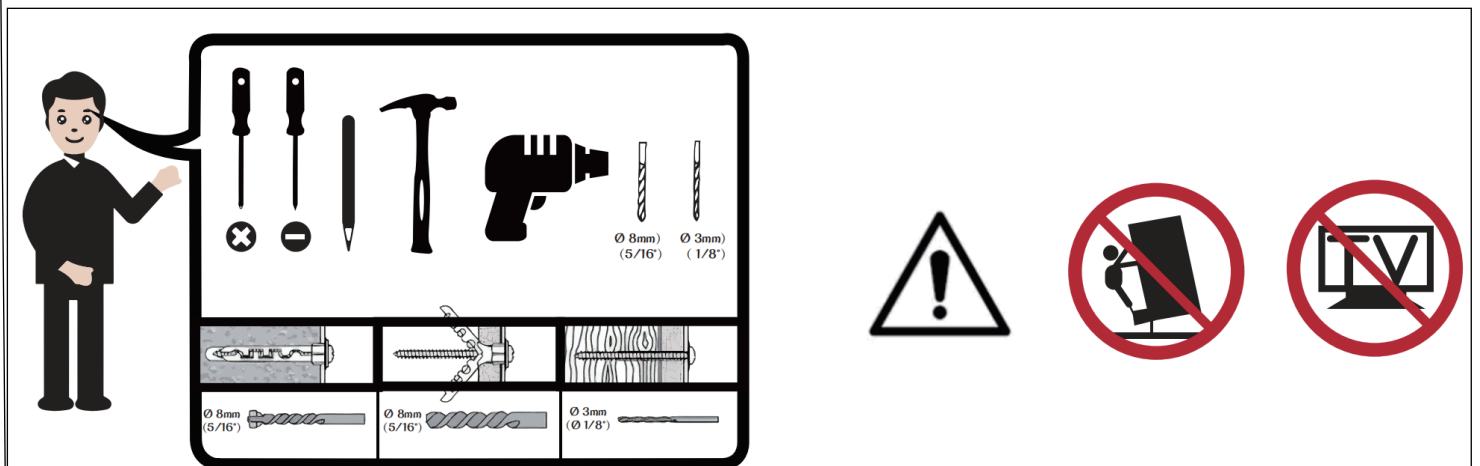

AVERTISSEMENT — Risque de basculement / d'écrasement
Les meubles peuvent basculer et causer des blessures graves par écrasement. Si un kit antirupture est fourni, installez-le après le montage et utilisez-le comme indiqué. Ne modifiez pas la structure de ce produit. Utilisez-le uniquement comme prévu et assurez-vous que toutes les fixations sont complètement serrées. Le fabricant n'est pas responsable des dommages ou blessures causés par des modifications non autorisées ou un montage inapproprié.

Retirer le film avant utilisation.

WARNING

Foam packaging materials are not toys and may present a choking hazard. Keep all foam packaging materials away from babies and children. Do not allow children to play with the packaging. If the packaging is torn, damaged, or any foam pieces become loose, remove and discard the material immediately.

To the maximum extent permitted by applicable law, the manufacturer and seller are not liable for injury, damage, or loss arising from improper installation, misuse, abuse, inadequate maintenance, unauthorized modification, or failure to follow the product instructions and warnings. This limitation does not exclude liability that cannot be excluded under applicable law.

AVERTISSEMENT

Les matériaux d'emballage en mousse ne sont pas des jouets et peuvent présenter un risque d'étouffement. Gardez tous les matériaux d'emballage en mousse hors de portée des bébés et des enfants. Ne laissez pas les enfants jouer avec l'emballage. Si l'emballage est déchiré, endommagé, ou si des morceaux de mousse se détachent, retirez immédiatement ce matériau et jetez-le.

Dans toute la mesure permise par la loi applicable, le fabricant et le vendeur déclinent toute responsabilité en cas de blessure, dommage ou perte résultant d'une installation incorrecte, d'une mauvaise utilisation, d'un usage abusif, d'un entretien insuffisant, d'une modification non autorisée, ou du non-respect des instructions et avertissements du produit. Cette limitation n'exclut pas la responsabilité qui ne peut être exclue en vertu de la loi applicable.

Explosion Diagram

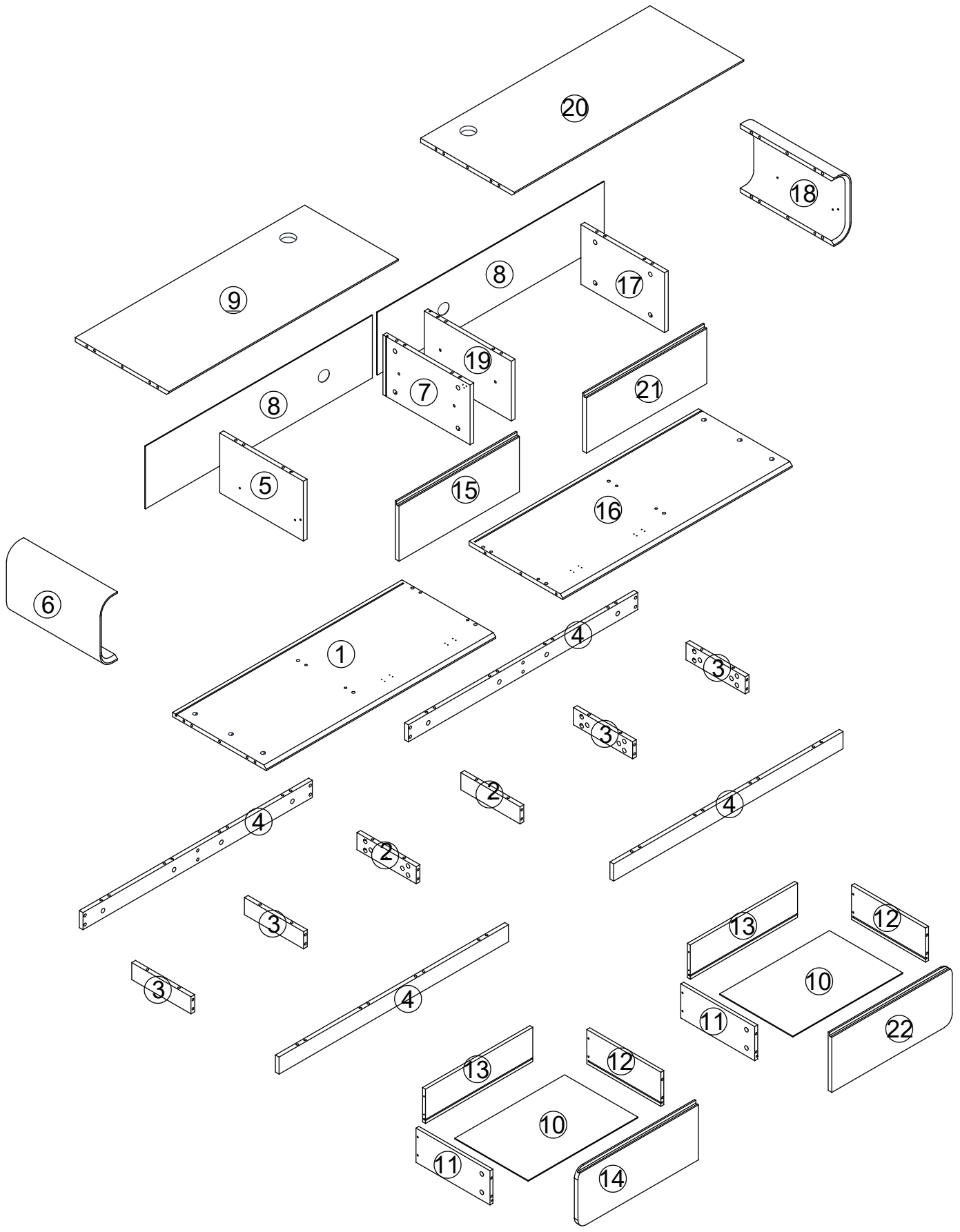

Parts List

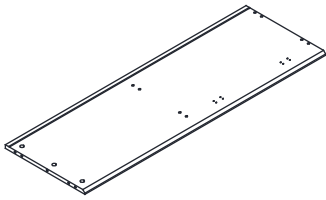

① X1

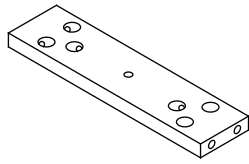

② X4

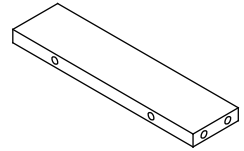

③ X4

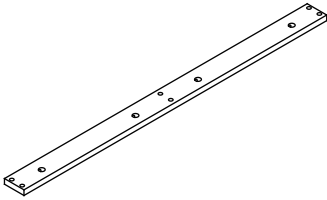

④ X4

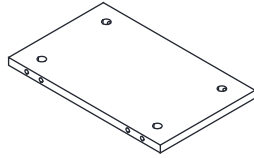

⑤ X1

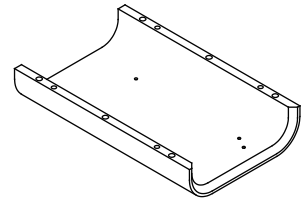

⑥ X1

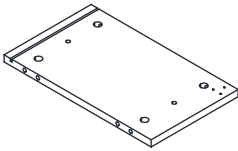

⑦ X1

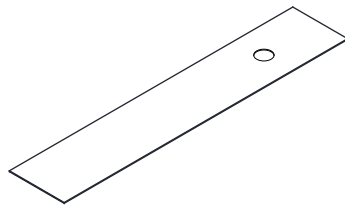

⑧ X2

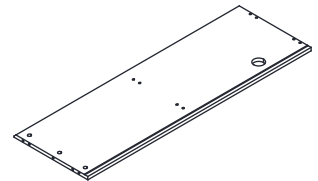

⑨ X1

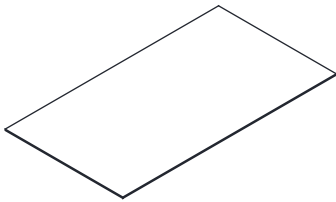

⑩ X2

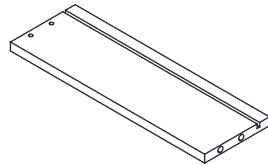

⑪ X2

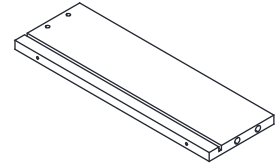

⑫ X2

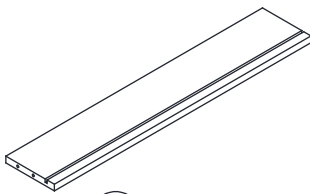

⑬ X2

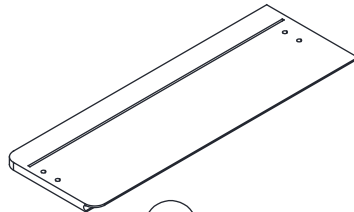

⑭ X1

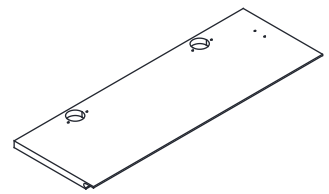

⑮ X1

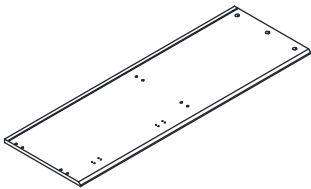

⑯ X1

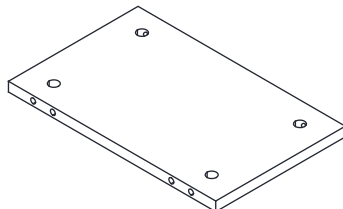

⑰ X1

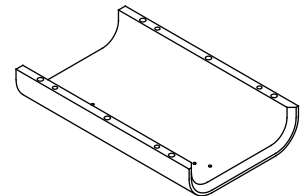

⑱ X1

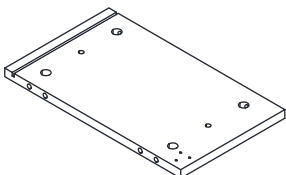

⑲ X1

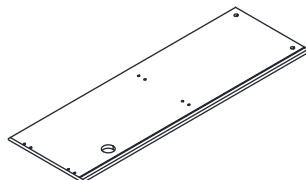

⑳ X1

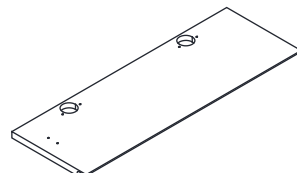



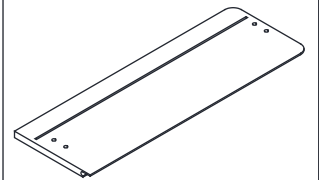





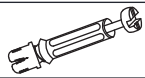

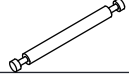
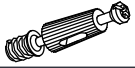





㉑ X1

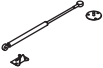
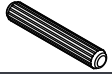

㉒ X1



Hardware List

No.	Code	Diagram	Description	Quantity	Spare
1	A1			76	2
2	A2		Ø15 x 9.5 mm	100	2
3	A3		Ø6 x 64 mm	6	
4	A4			12	2
5	B1		Ø3.5 x 14 mm	66	2
6	B2		Ø3.5 x 35 mm	8	2
7	B3		Ø6 x 30 mm	3	
8	C1		Ø8 x 40 mm	40	2
9	C2		Ø20 x 1 mm	20	
10	C3			6	
11			2		
12	C5			1	
13	C6			2	
14	C7			4	
15	C8			2	
16	C9		Ø8 x 60 mm	4	
17	CR		12" S ide (CR)	2	
18	CL		12" Slide (CL)	2	
19	DR		12" Slide (DR)	2	
20	DL		12" Slide (DL)	2	

THE SPARE BAG INCLUDED EXTRA HARDWARE FOR DAMAGED OR MISSING SMALL HARDWARE WHILE YOU ARE ASSEMBLING

Assemble

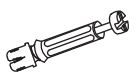
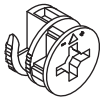

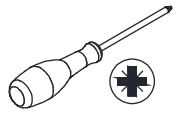
Step 1

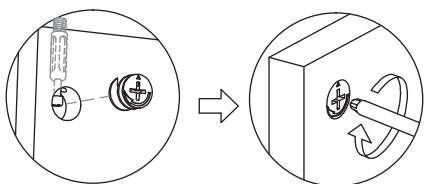
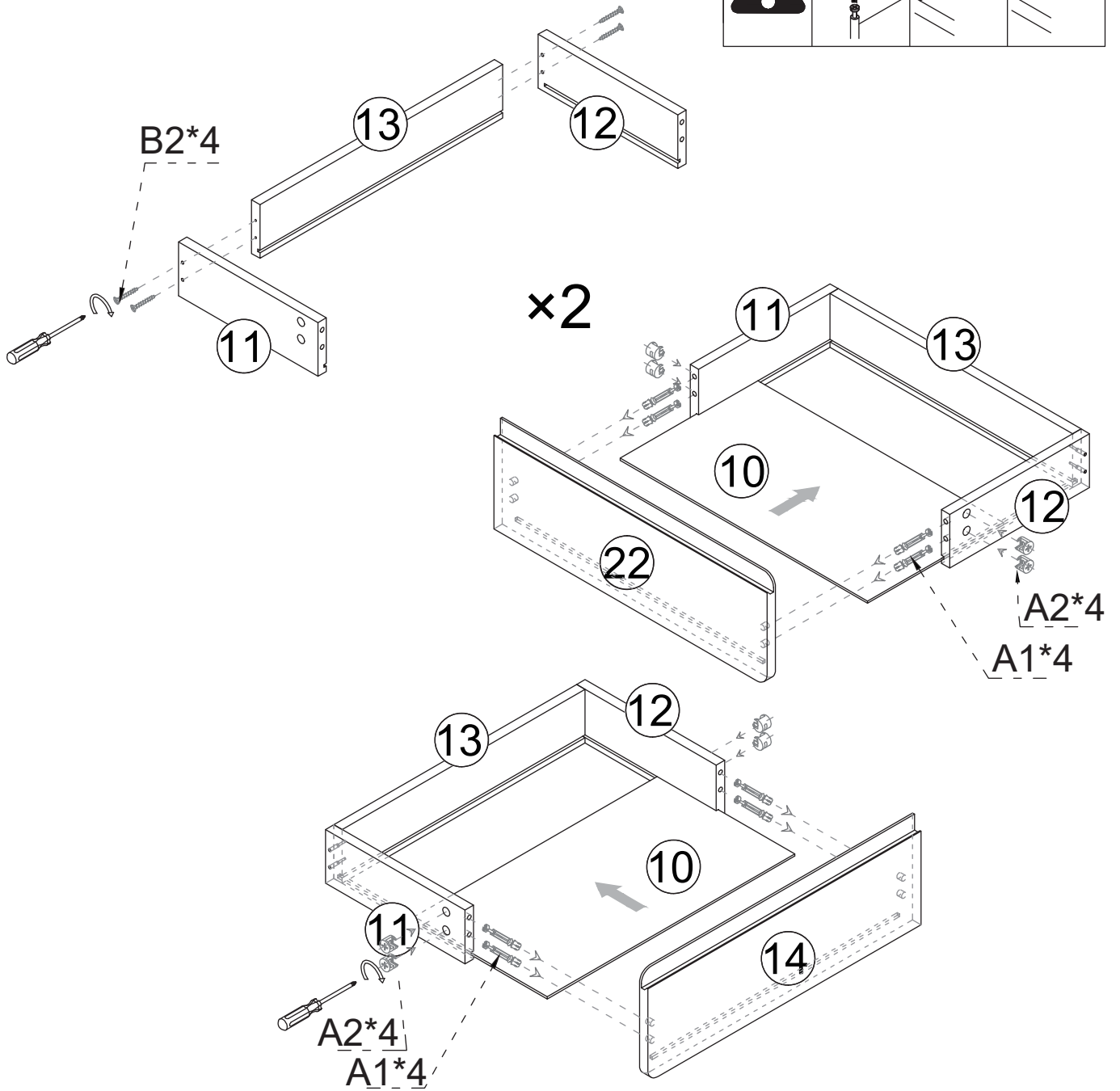
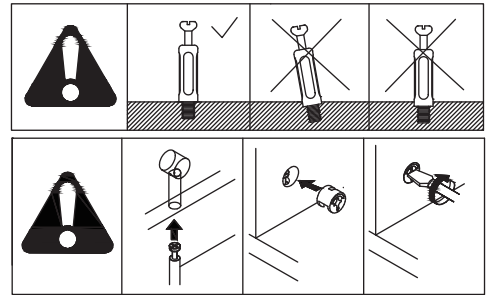
			
A1	8PCS	A2	8PCS
B2	8PCS		



Assemble

Step 2

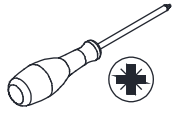

							
DR	2PCS	DL	2PCS	B1	8PCS		

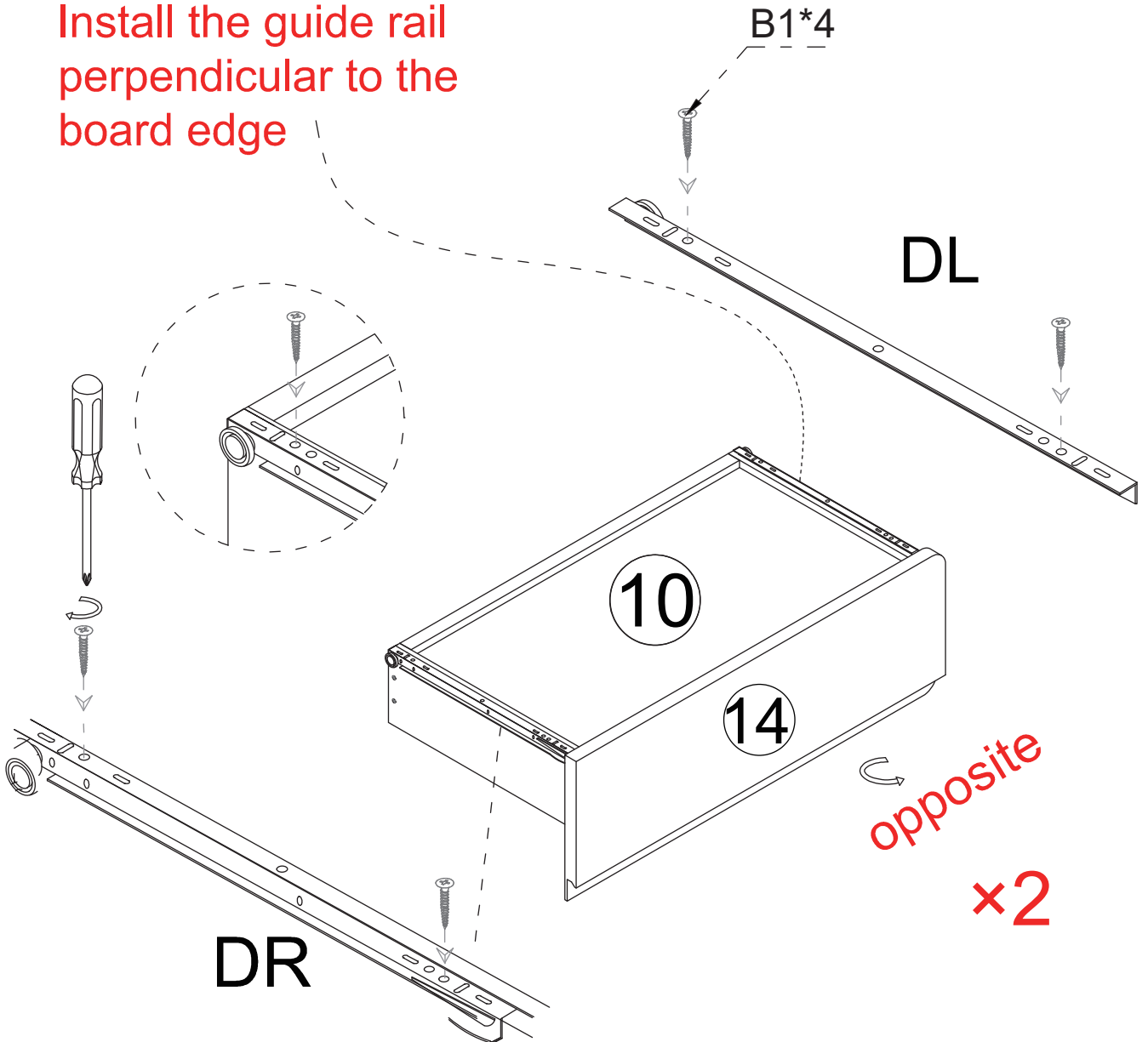
Install the guide rail perpendicular to the board edge



Assemble

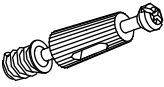
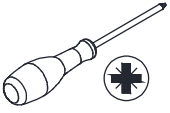

Step 3

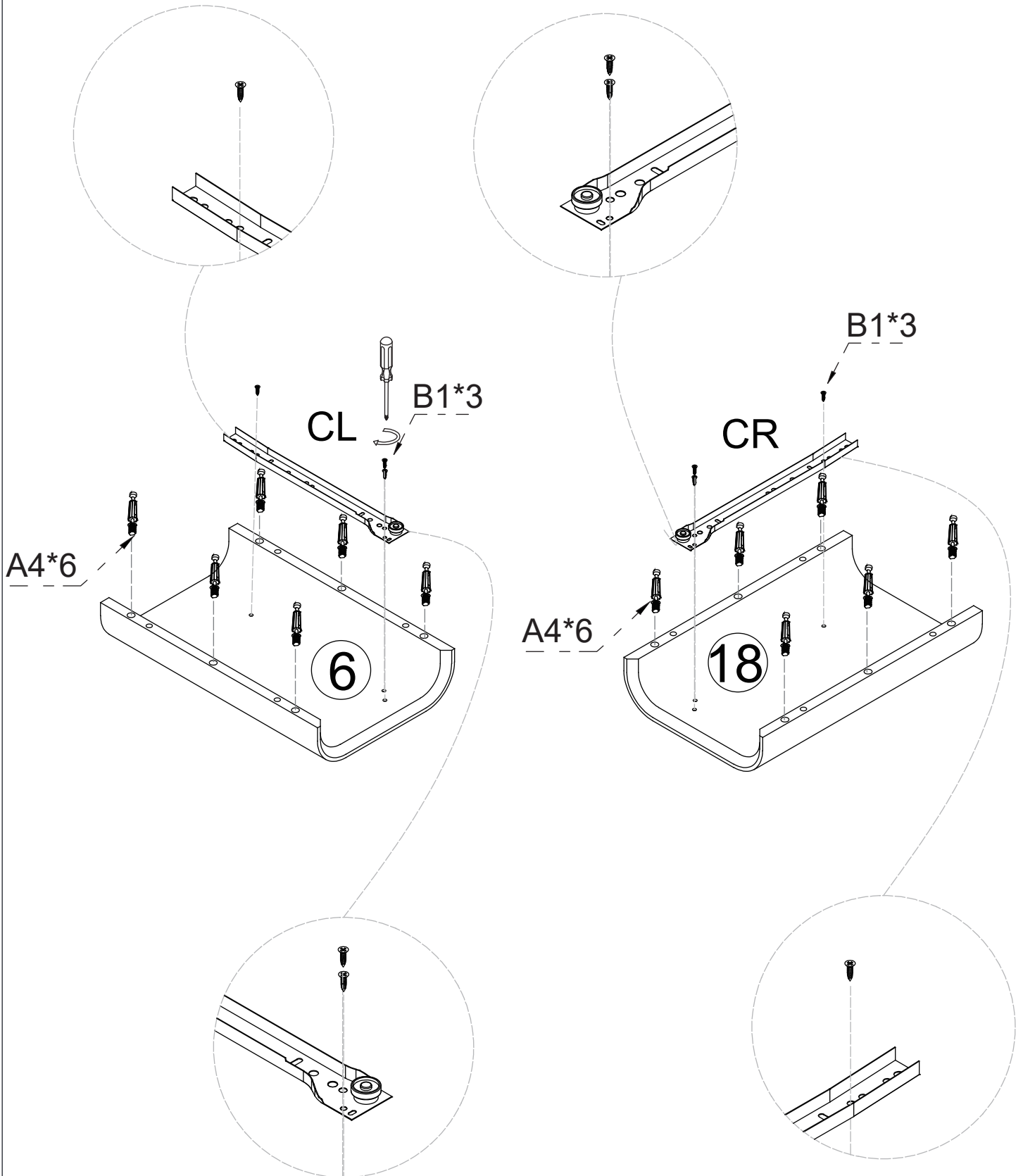
							
B1	6PCS	CR	1PCS	CL	1PCS	A4	12PCS



Assemble

Step 4

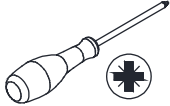
					
B1	6PCS	CR	1PCS	CL	1PCS

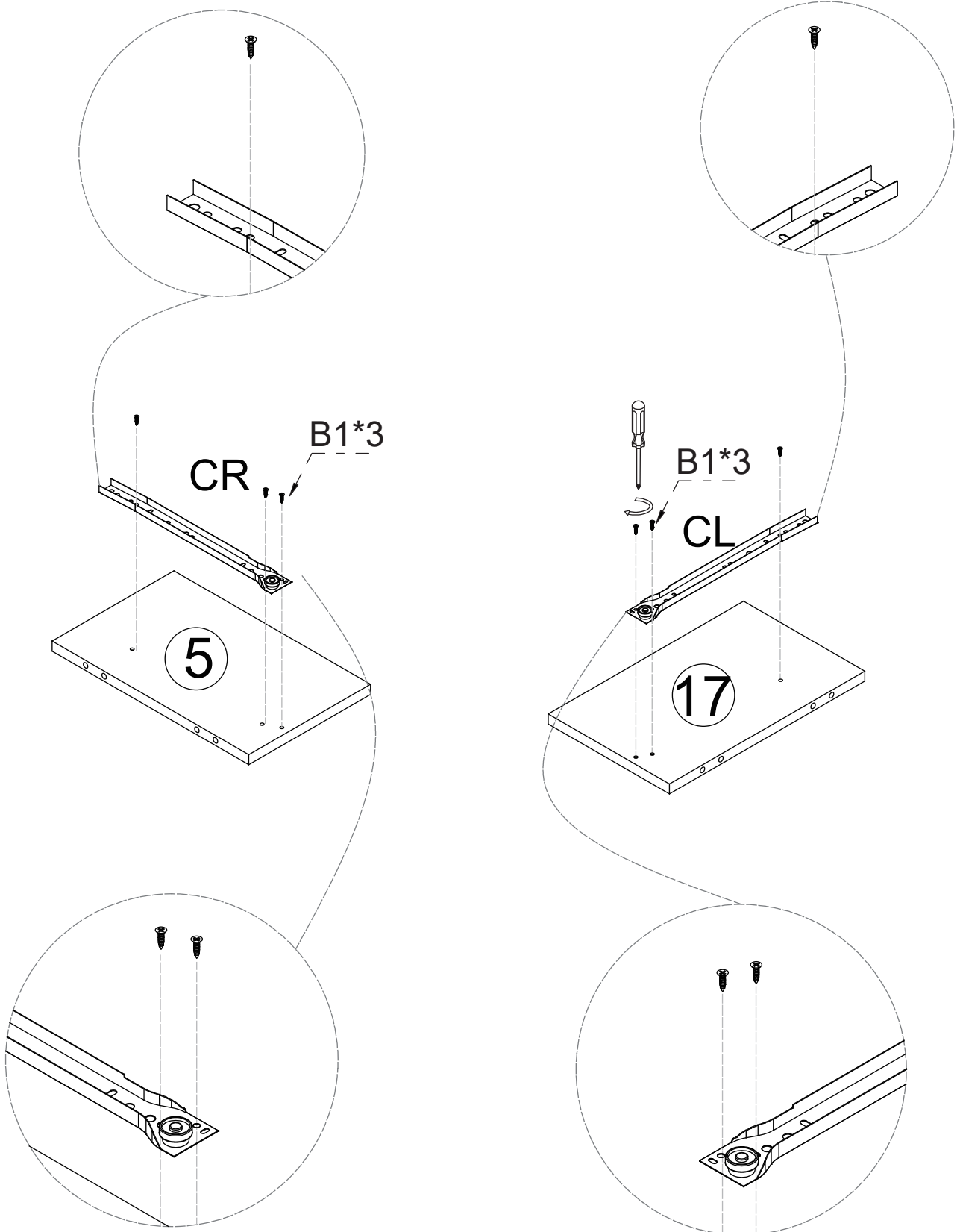

Assemble

Step 5

		
A1	24 PCS	

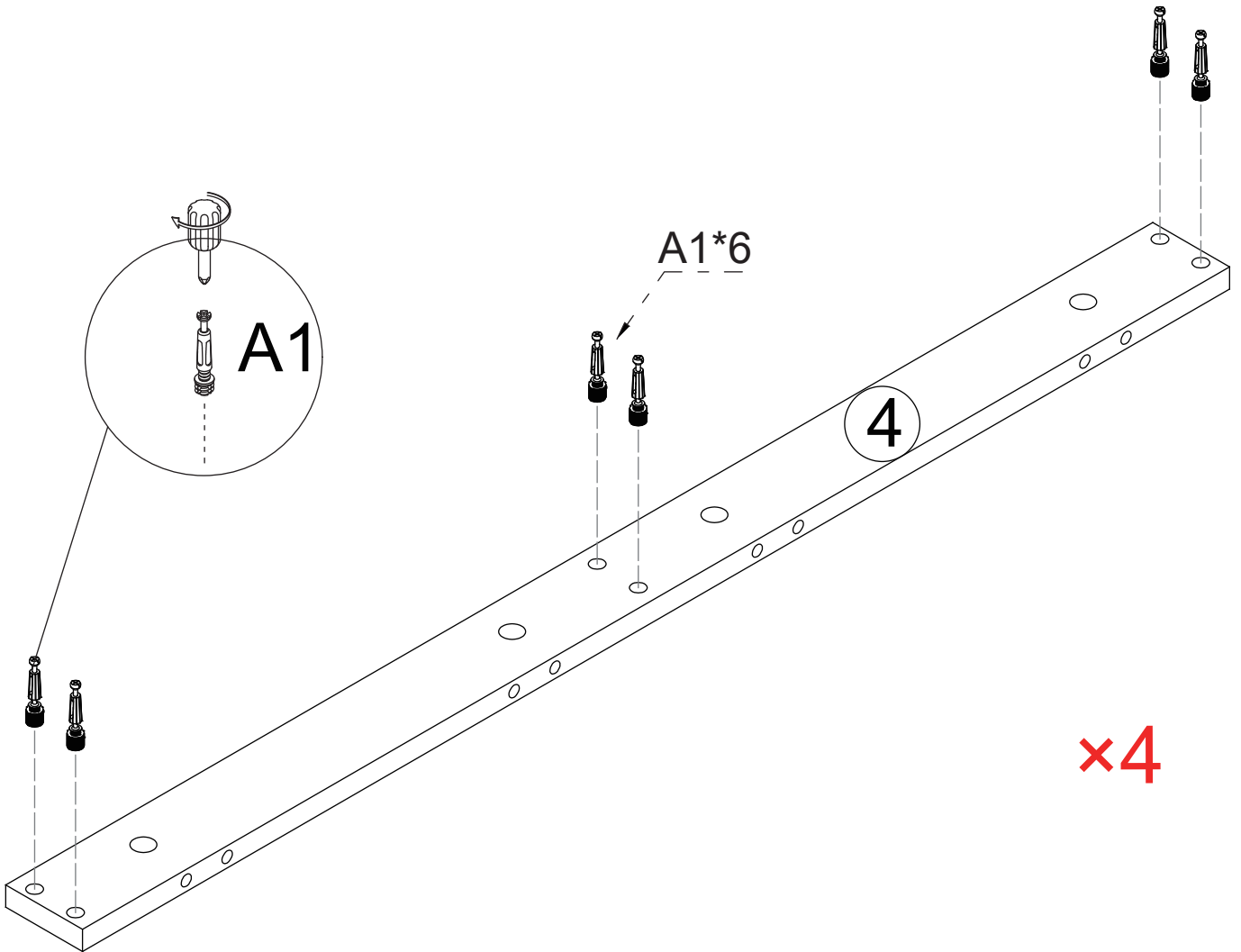
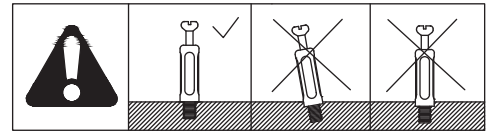

Assemble

Step 6

		
A2	24 PCS	

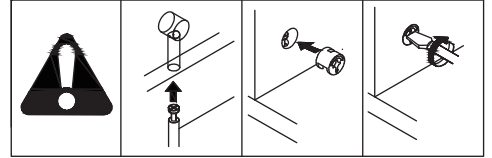

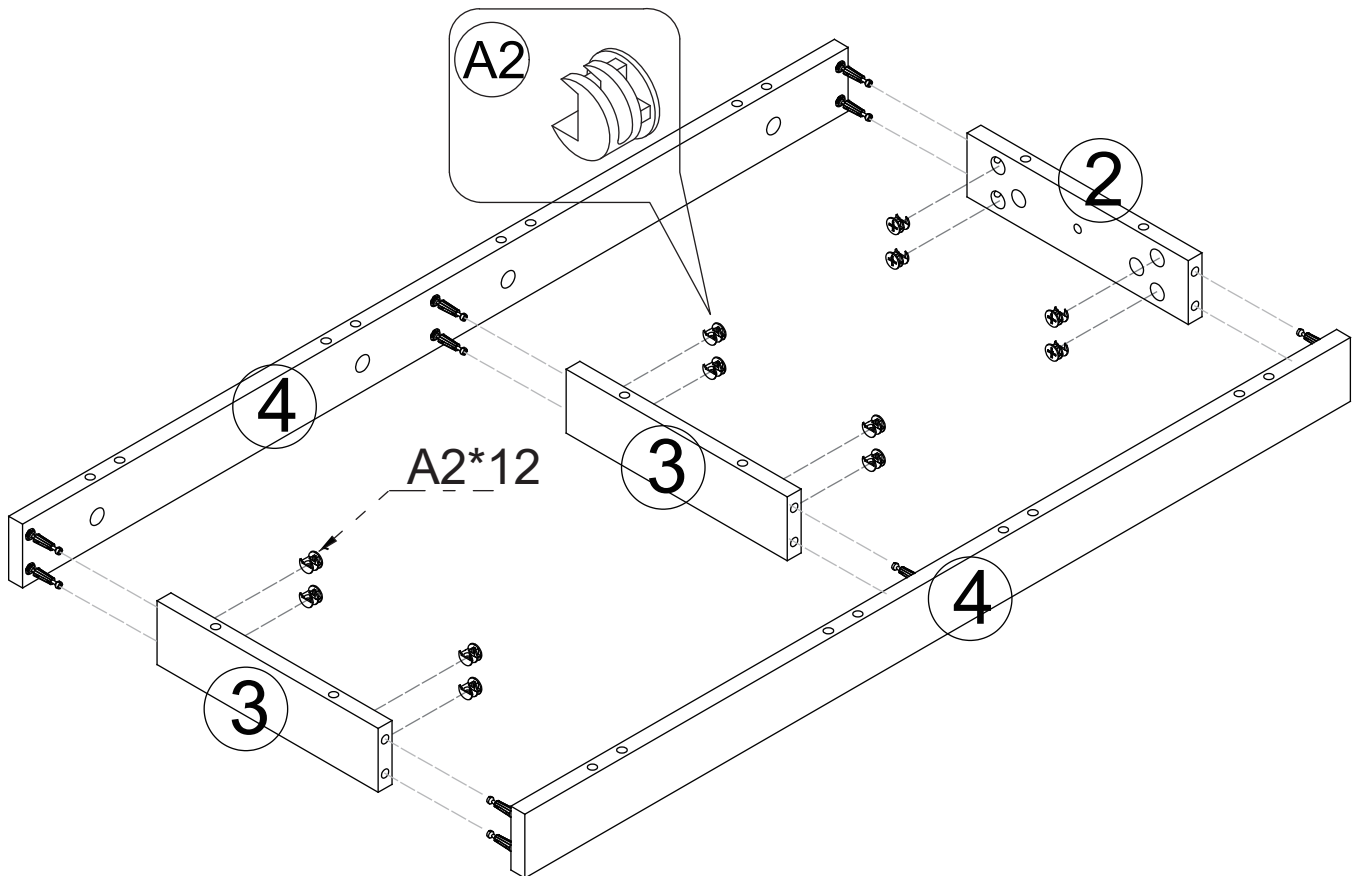

Wall-mounted ignore
this step



x2

Assemble

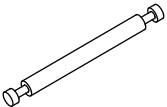
Step 7

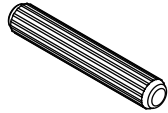
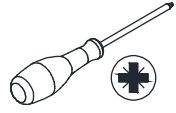
					
A3	3PCS	A2	6PCS	C9	2PCS

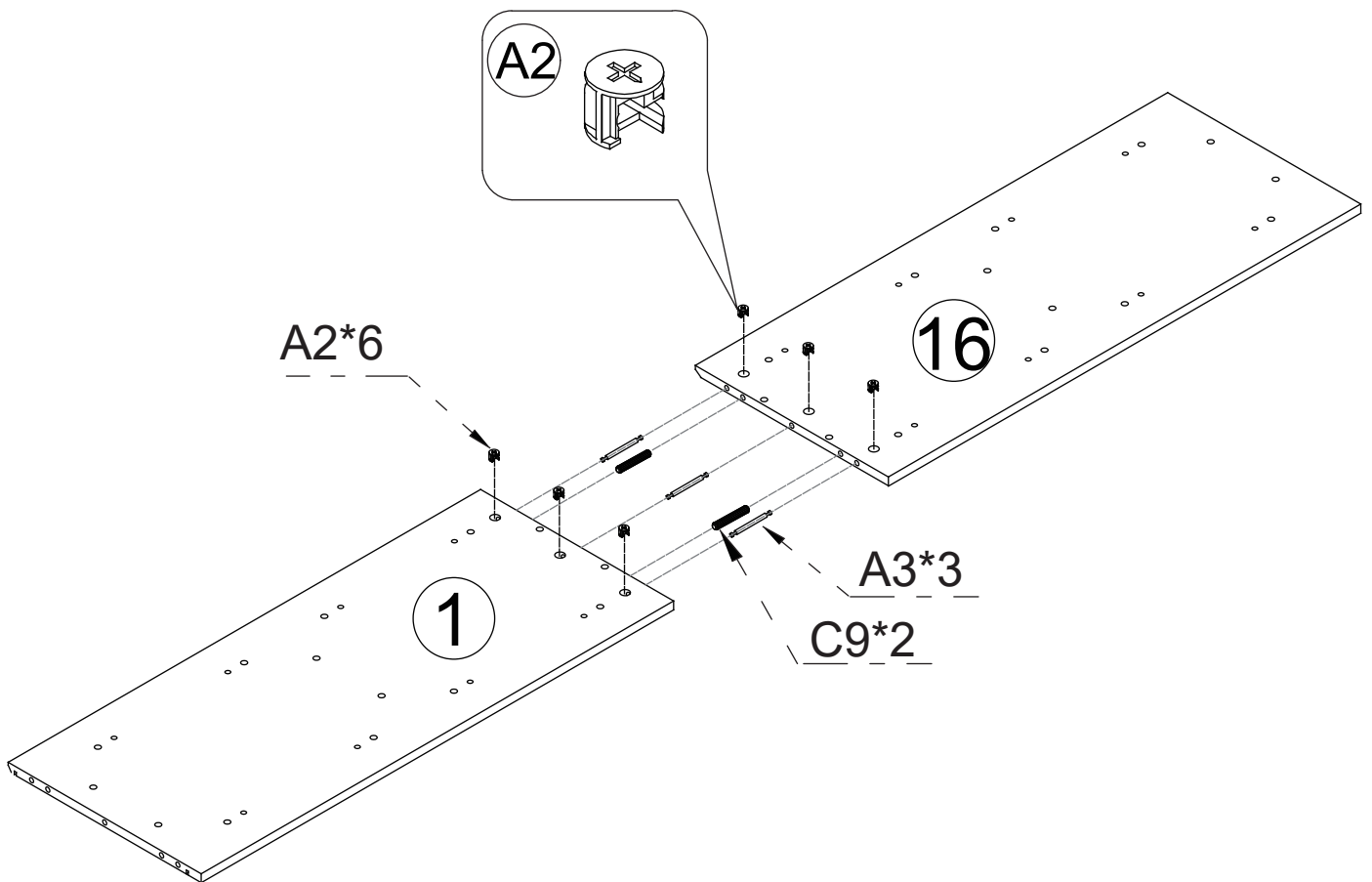
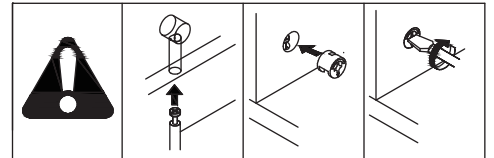
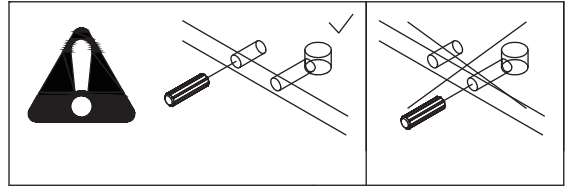

Assemble

Step 8

		
A1	28 PCS	

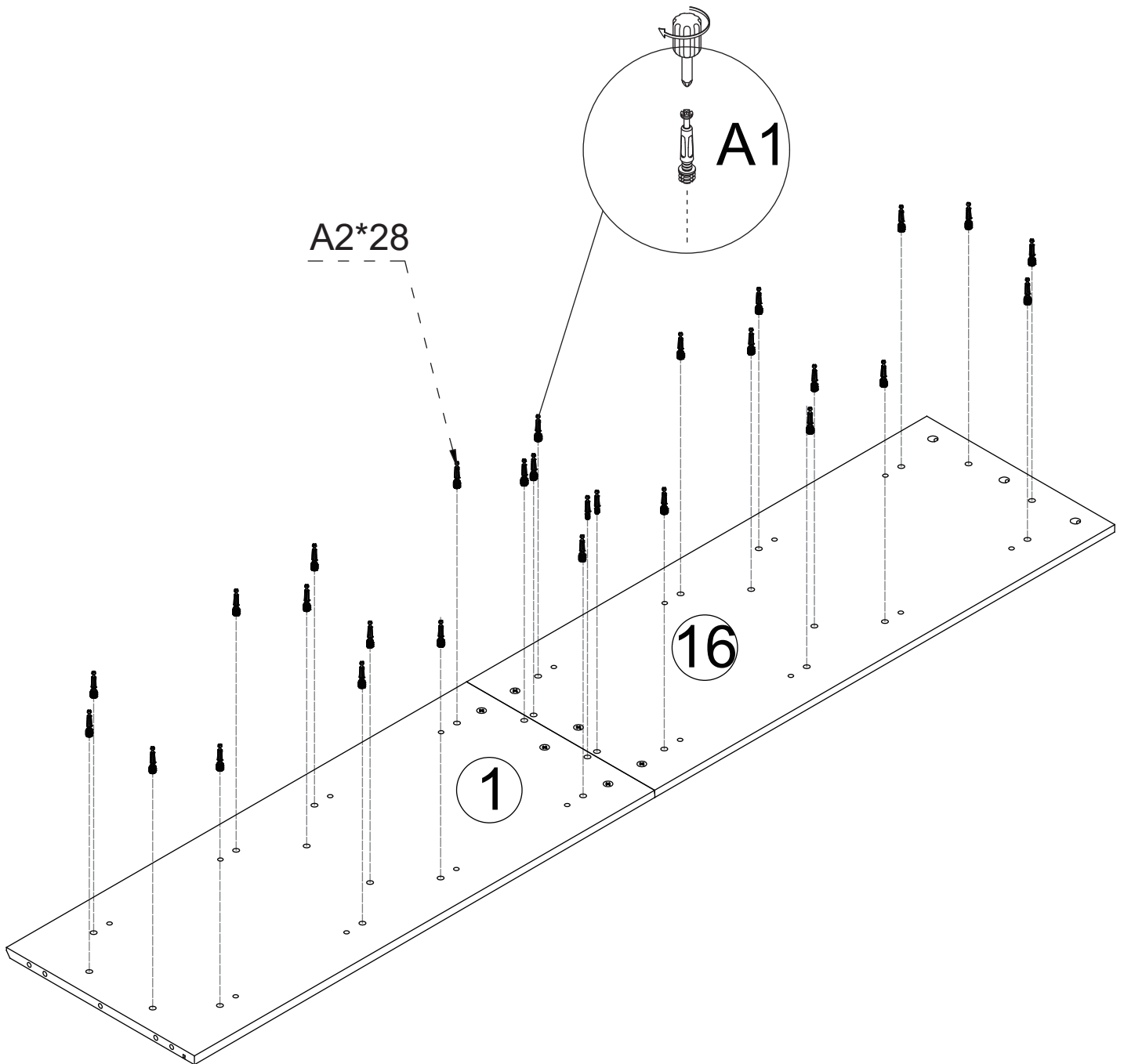
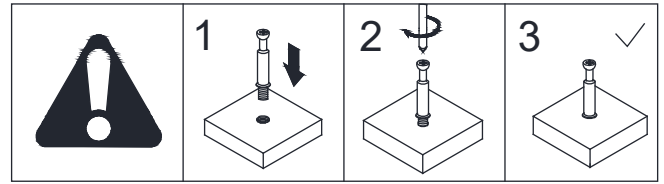

Assemble

Step 9

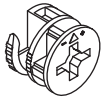
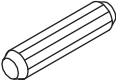
			
A2	14PCS	C1	8PCS

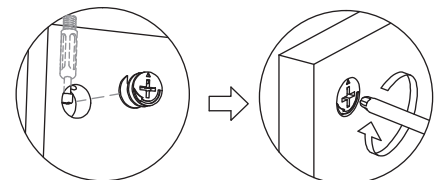
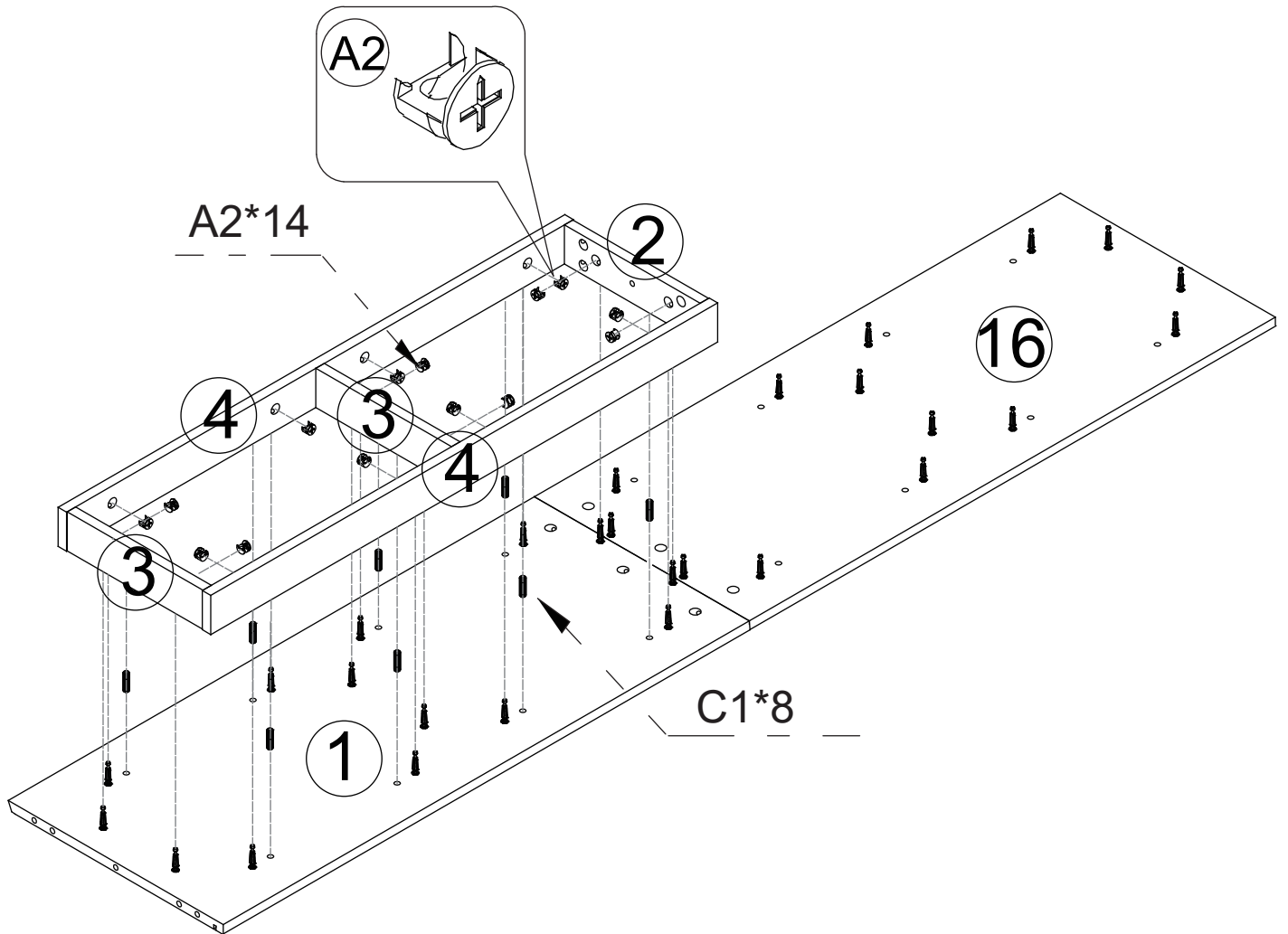
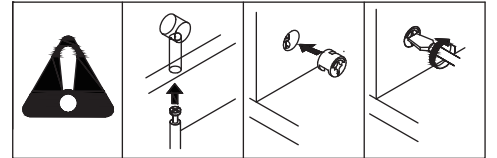
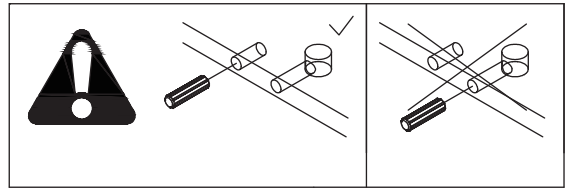

Assemble

Step 10

			
A2	14PCS	C1	8PCS

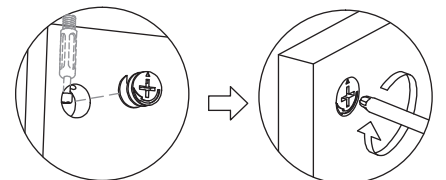
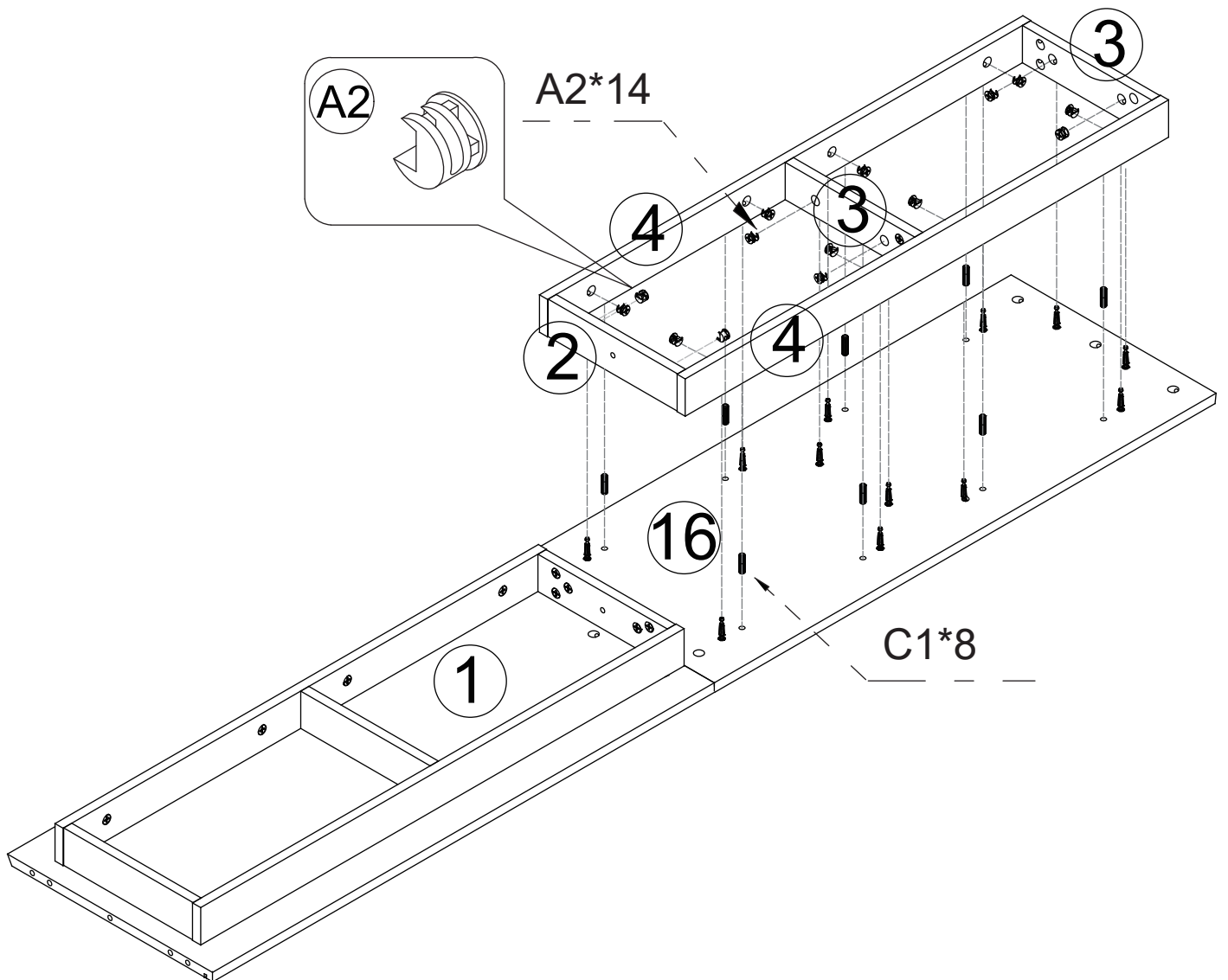
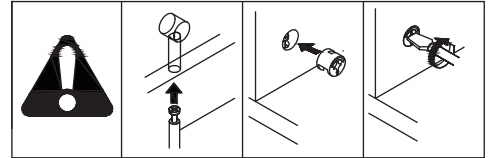
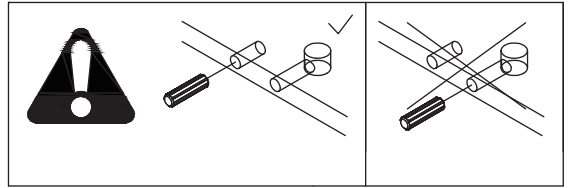

Assemble

Step 11

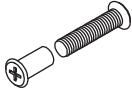
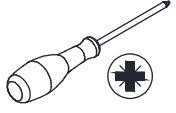
		
B3	1PCS	

Two people lift from the middle; do not lift from both ends. Align with the holes.

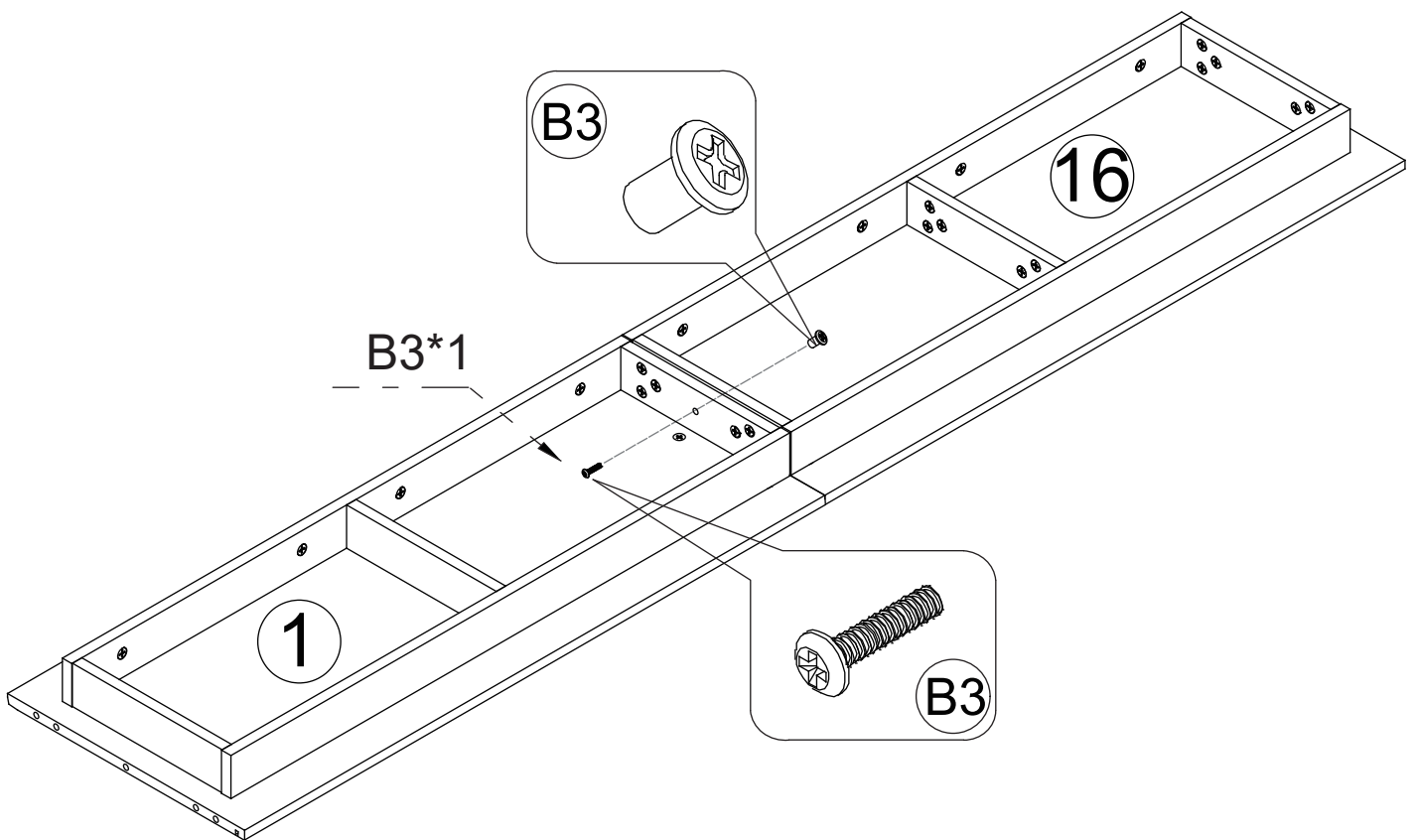

ROTATE 180°

Assemble

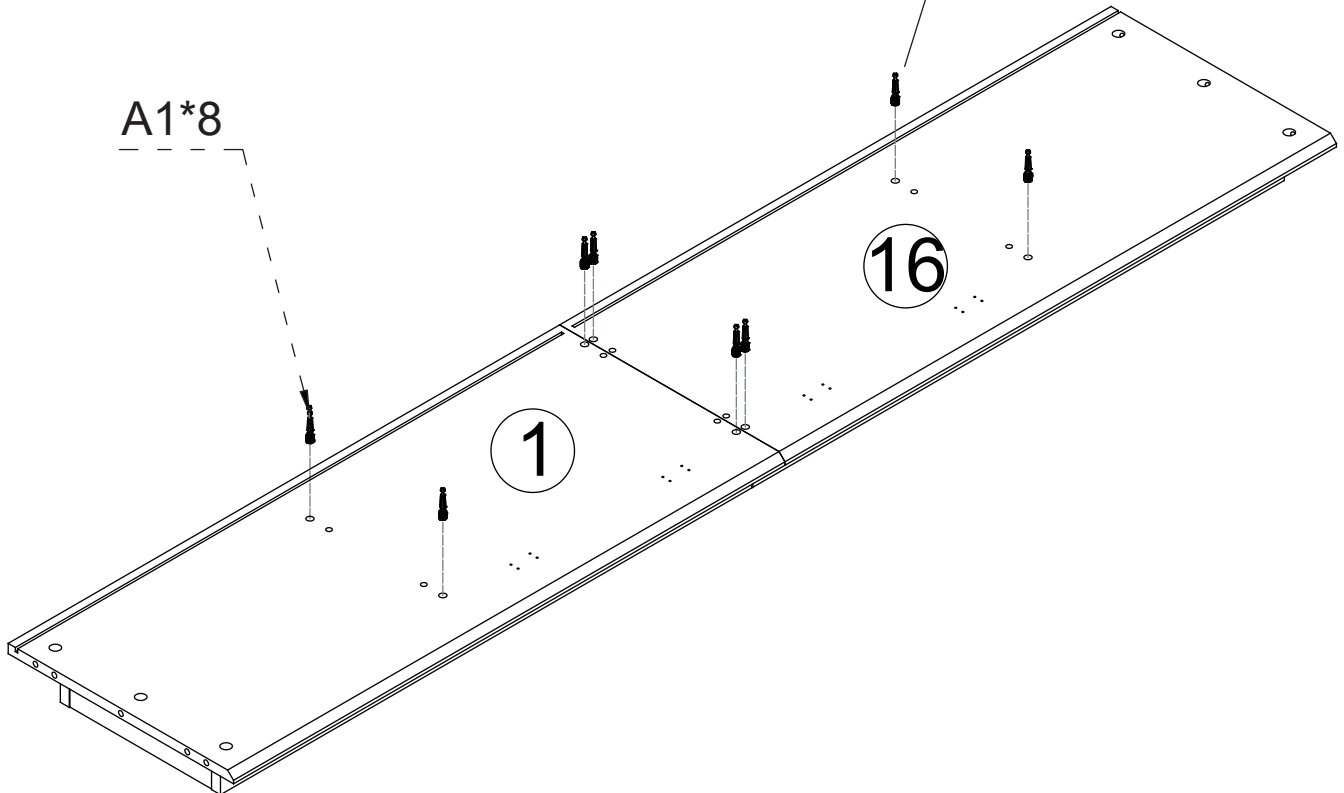
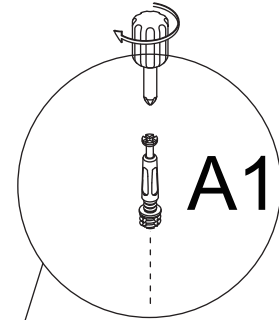
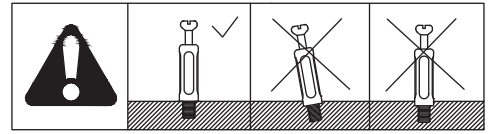

Step 12

			
A1	8PCS		

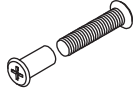
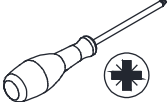

Assemble

Step 13

		
B3	2PCS	

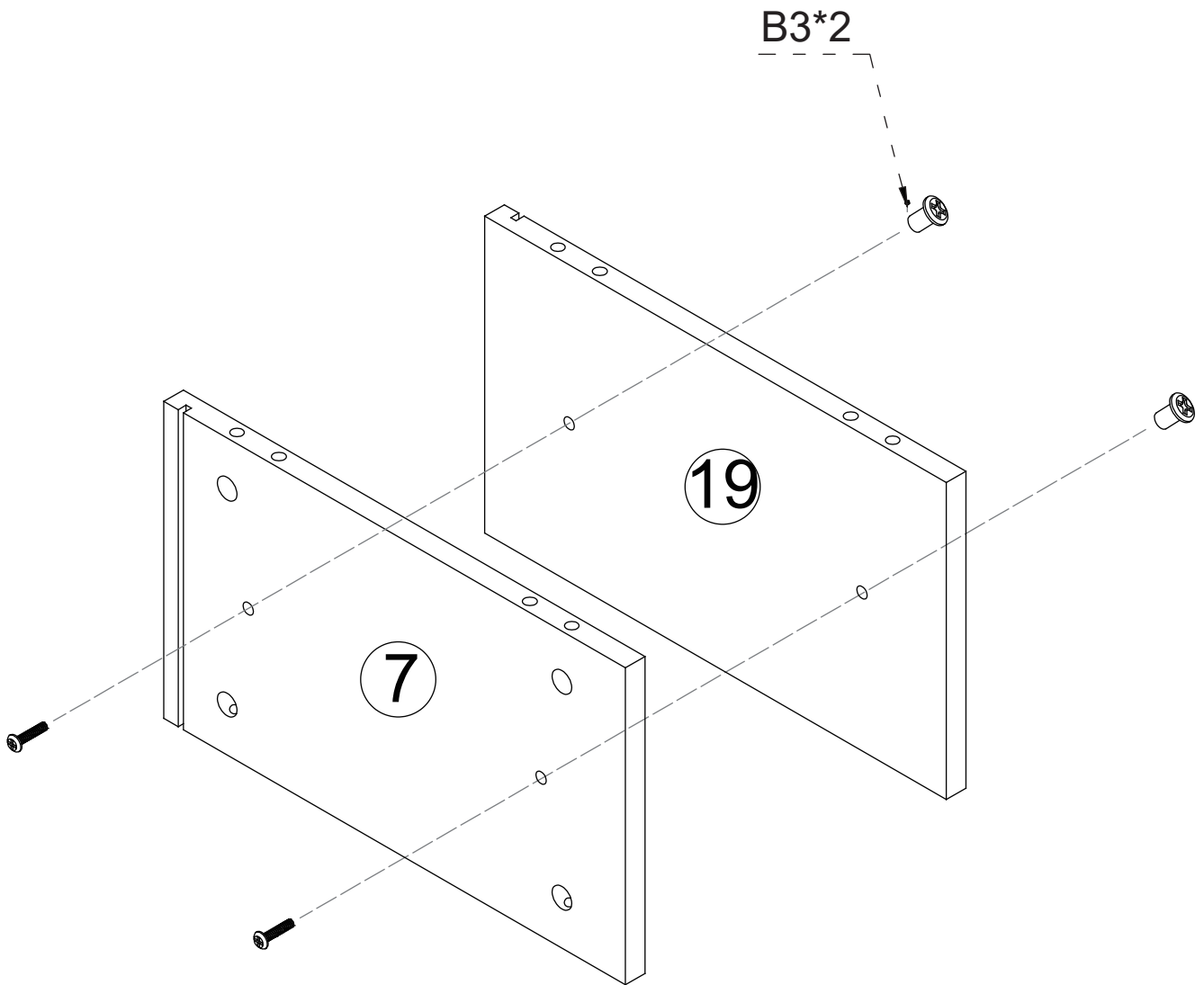

Assemble

Step 14

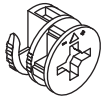
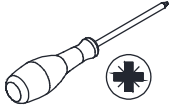
			
A2	8PCS	C1	8PCS

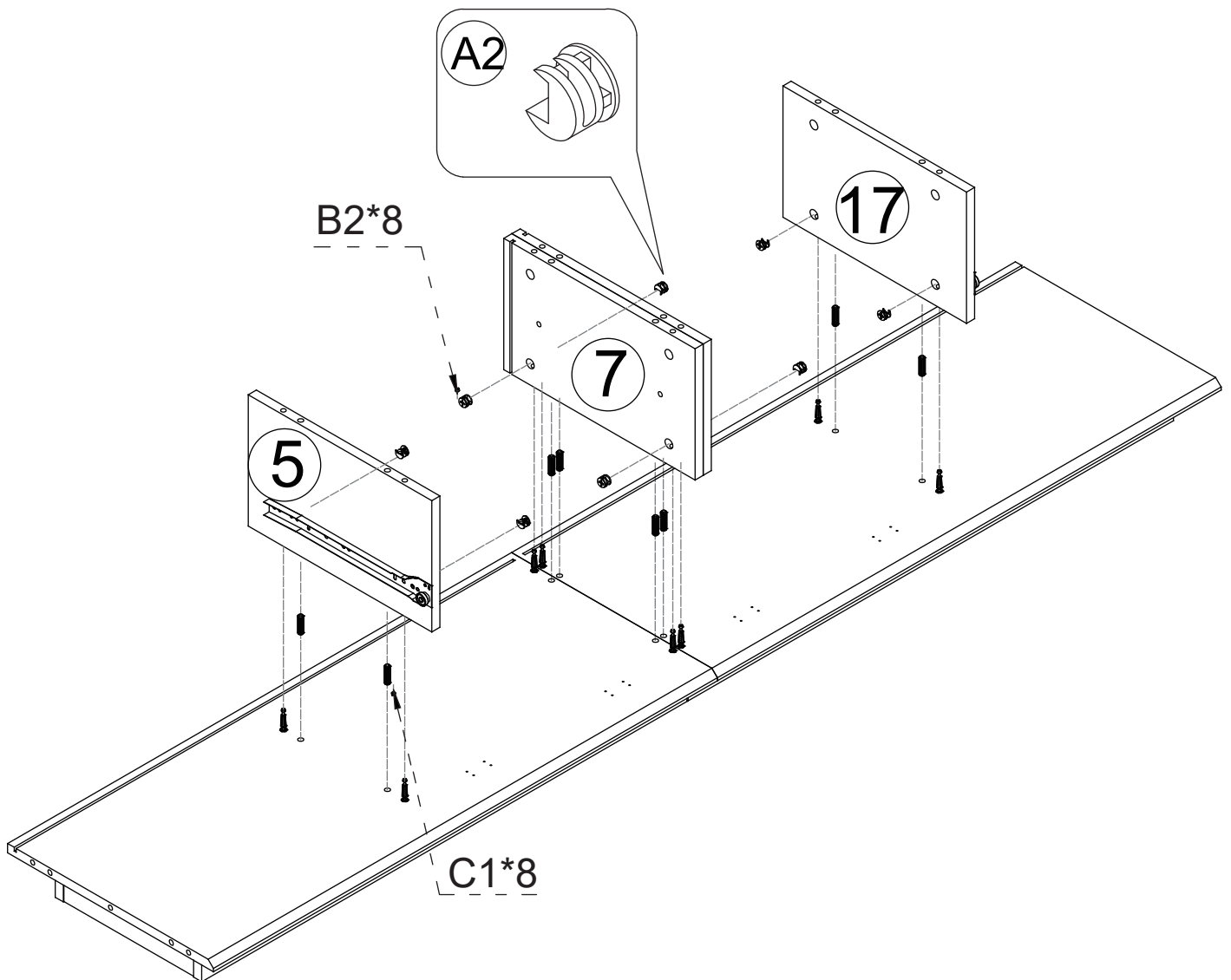
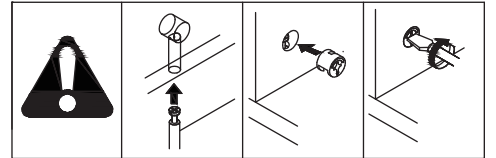
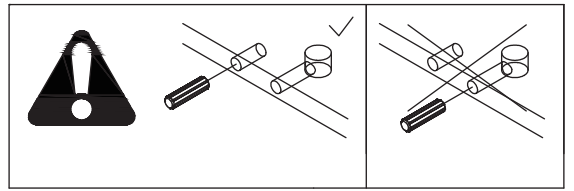

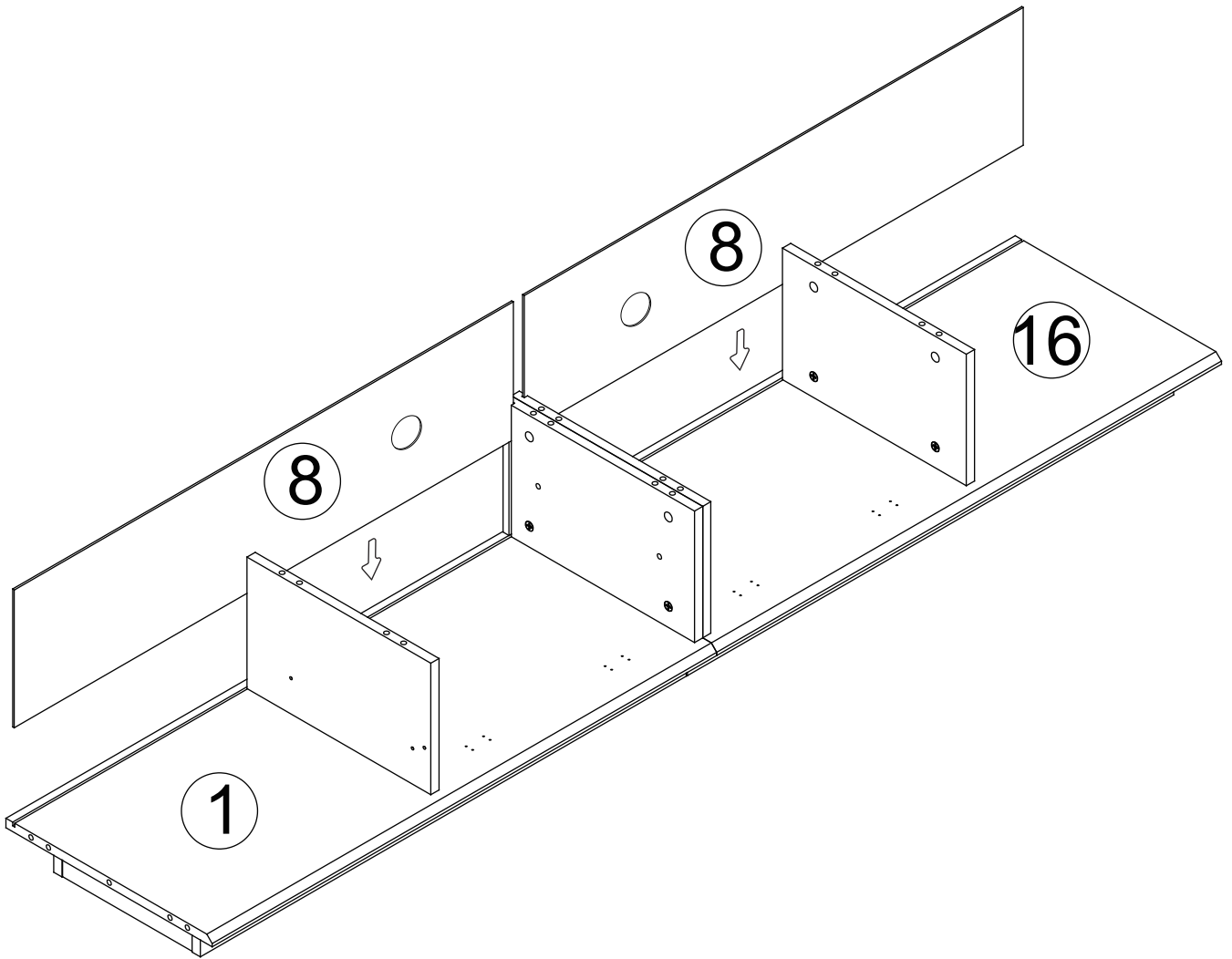
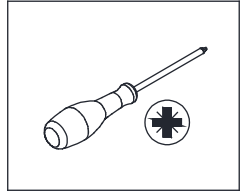

Assemble

Step 15

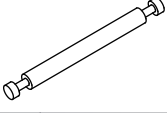
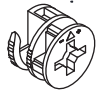

Assemble

Step 16

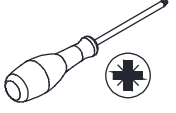
					
A3	3PCS	A2	6 PCS	C9	2PCS

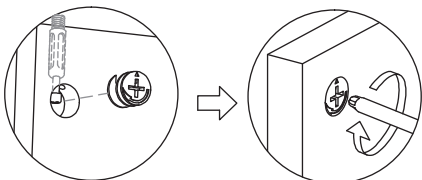
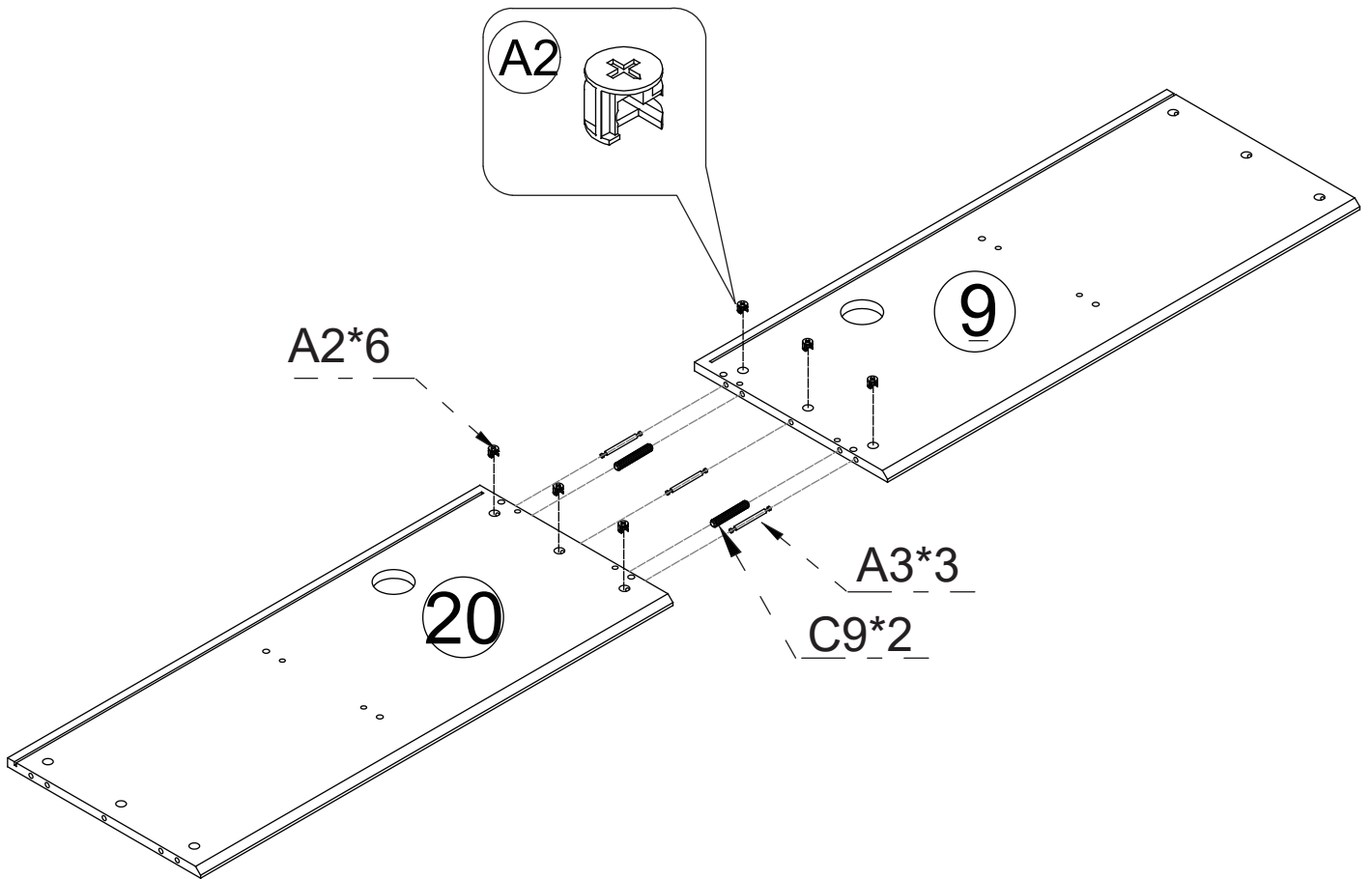
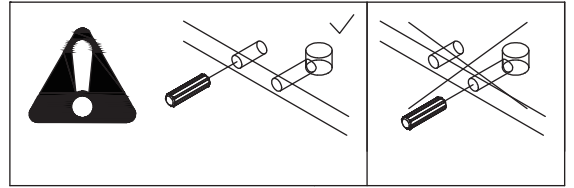

Assemble

Step 17

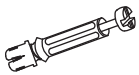
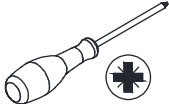
			
A1	8PCS		

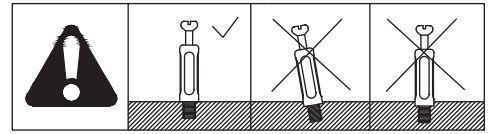

Two people lift from the middle; do not lift from both ends. Align with the holes.

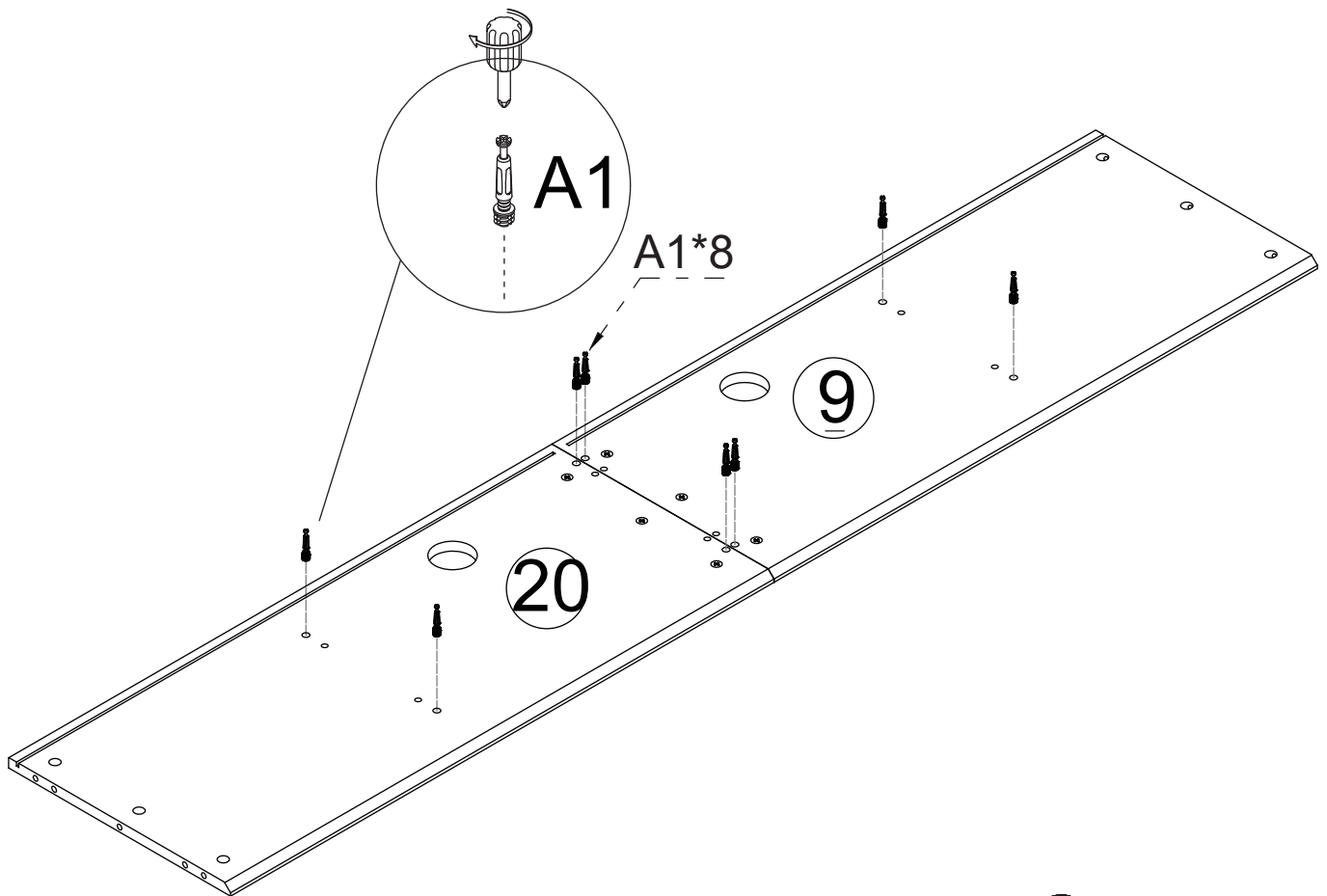

ROTATE 180°

Assemble

Step 18

			
A2	8PCS	C1	8PCS

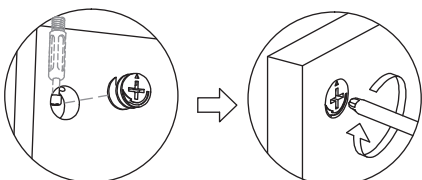
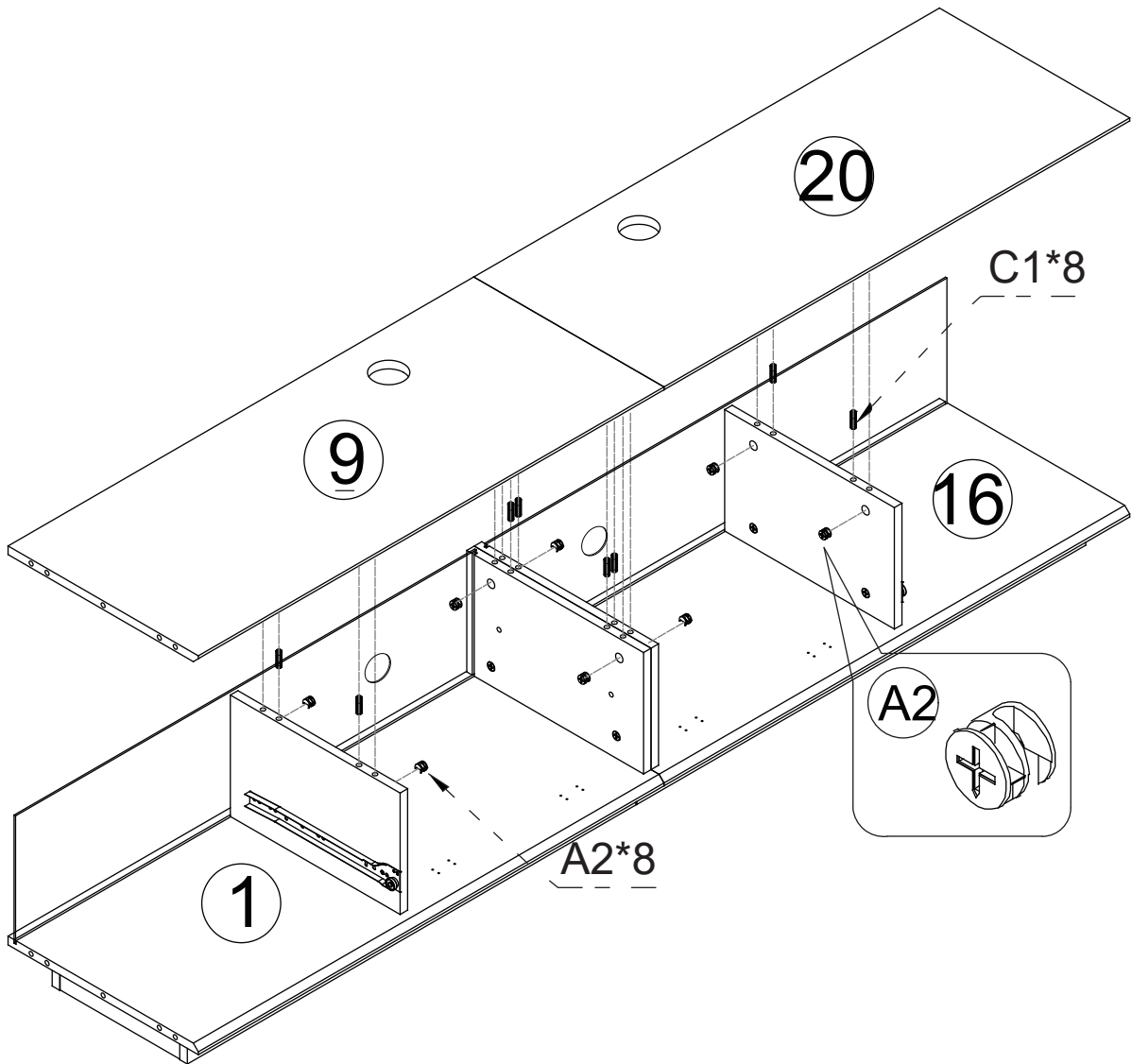
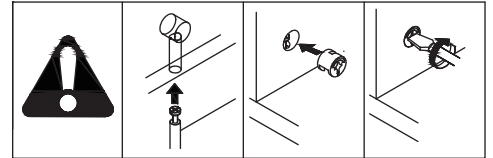
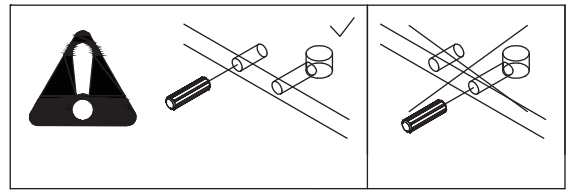

Assemble

Step 19

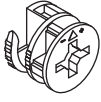
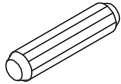
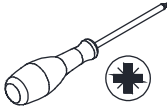
				
A2	6PCS	C1	4PCS	

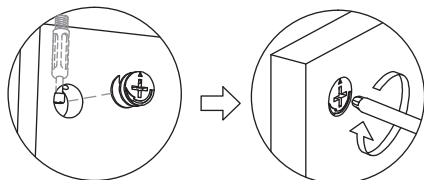
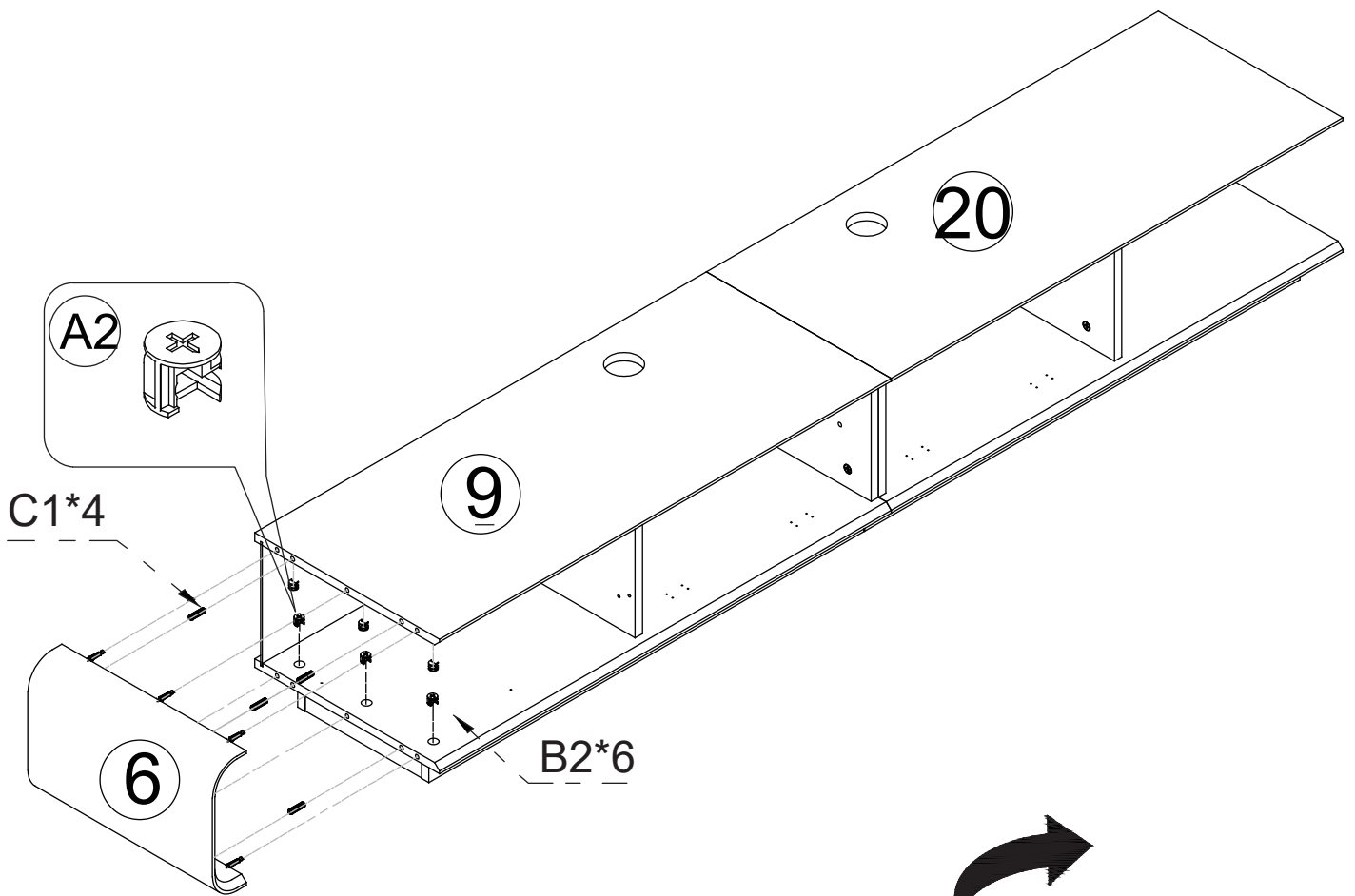
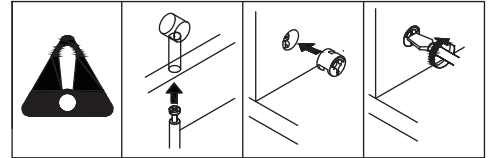
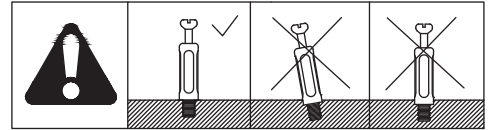
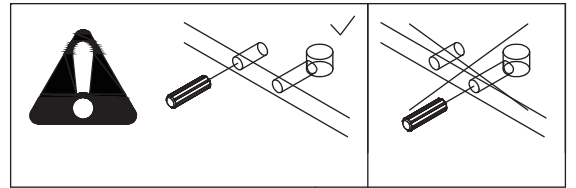

ROTATE 180°

Assemble

Step 20

			
A2	6PCS	C1	4PCS

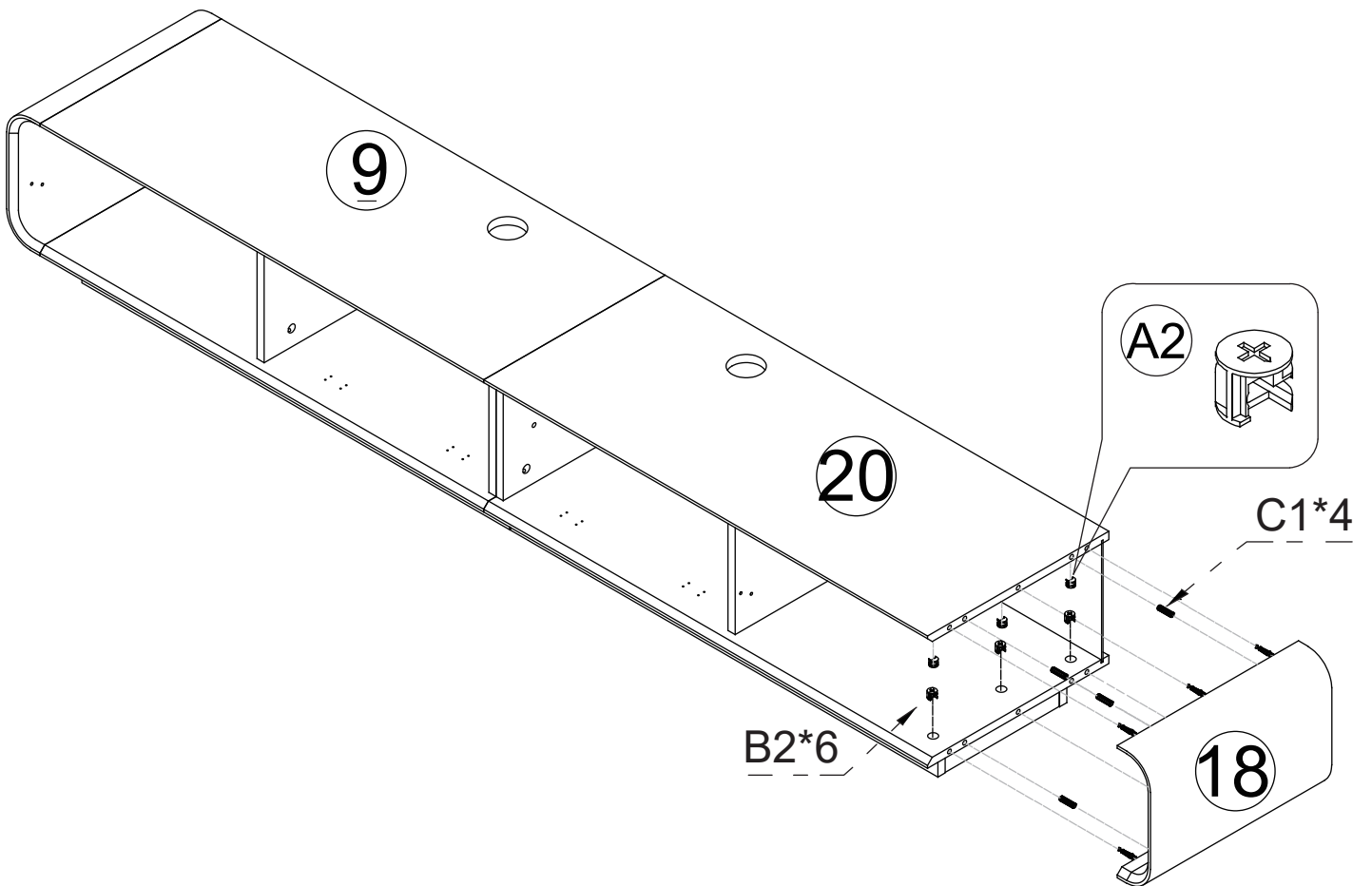
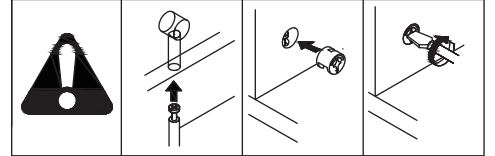
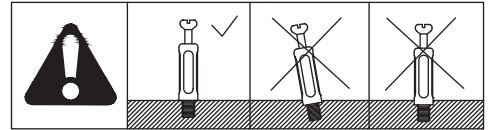
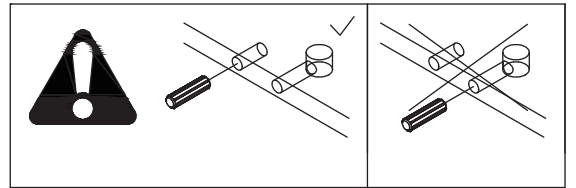

Assemble

Step 21

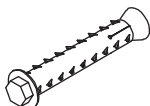
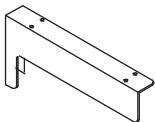
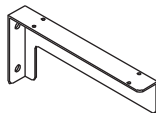
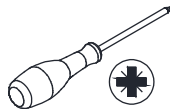
							
C3	6PCS	C4	2PCS	C5	1PCS		

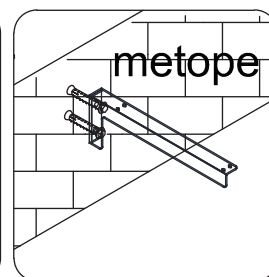
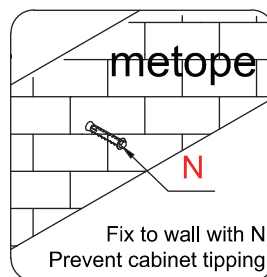
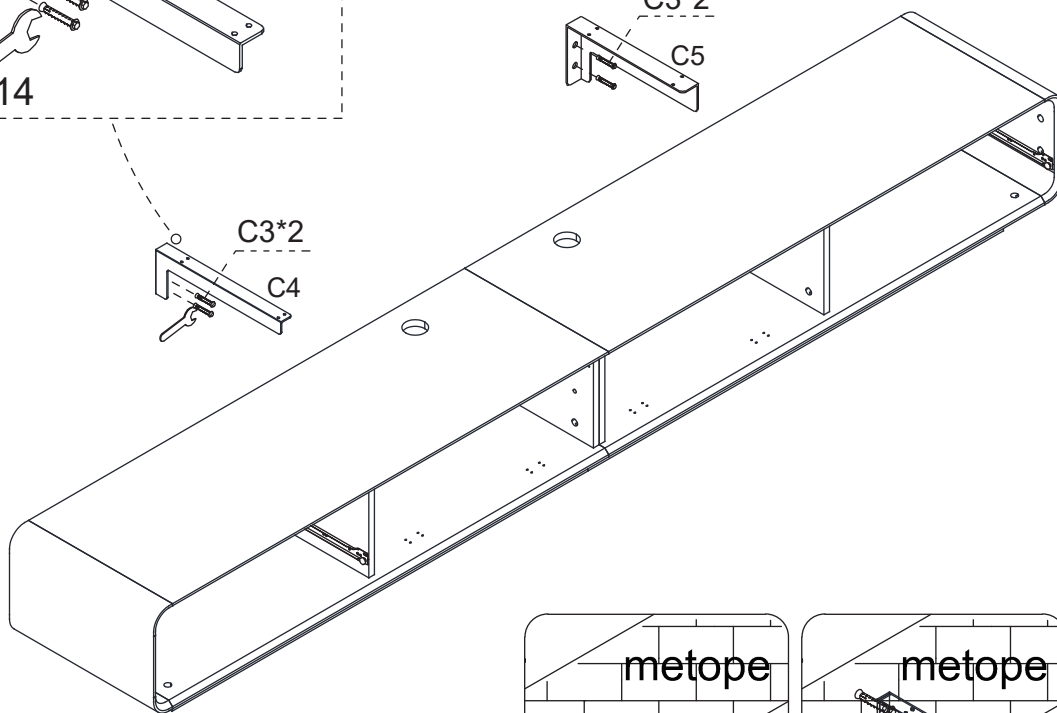
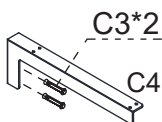
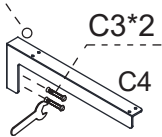
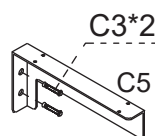
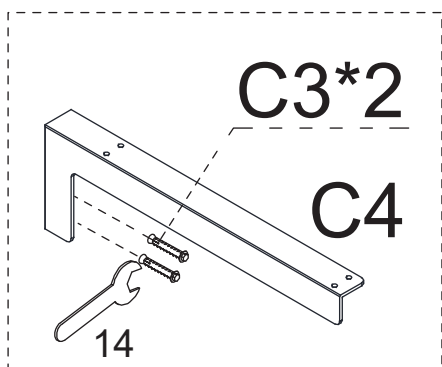
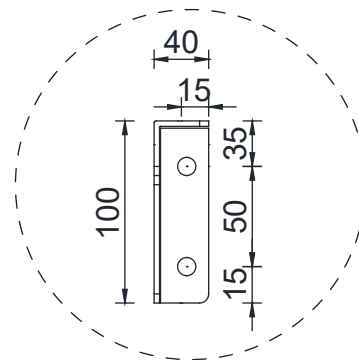
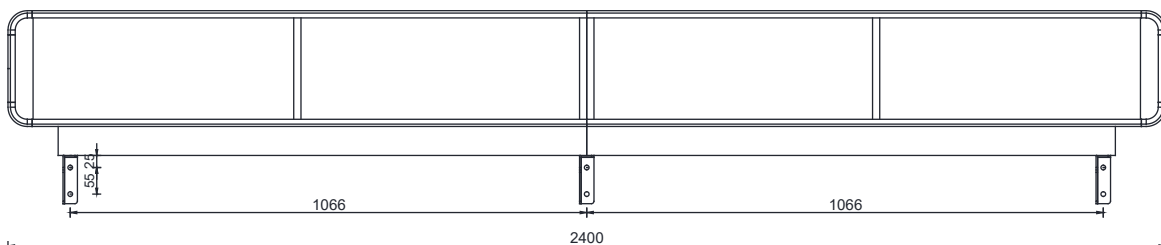

Step1

Step2

Assemble

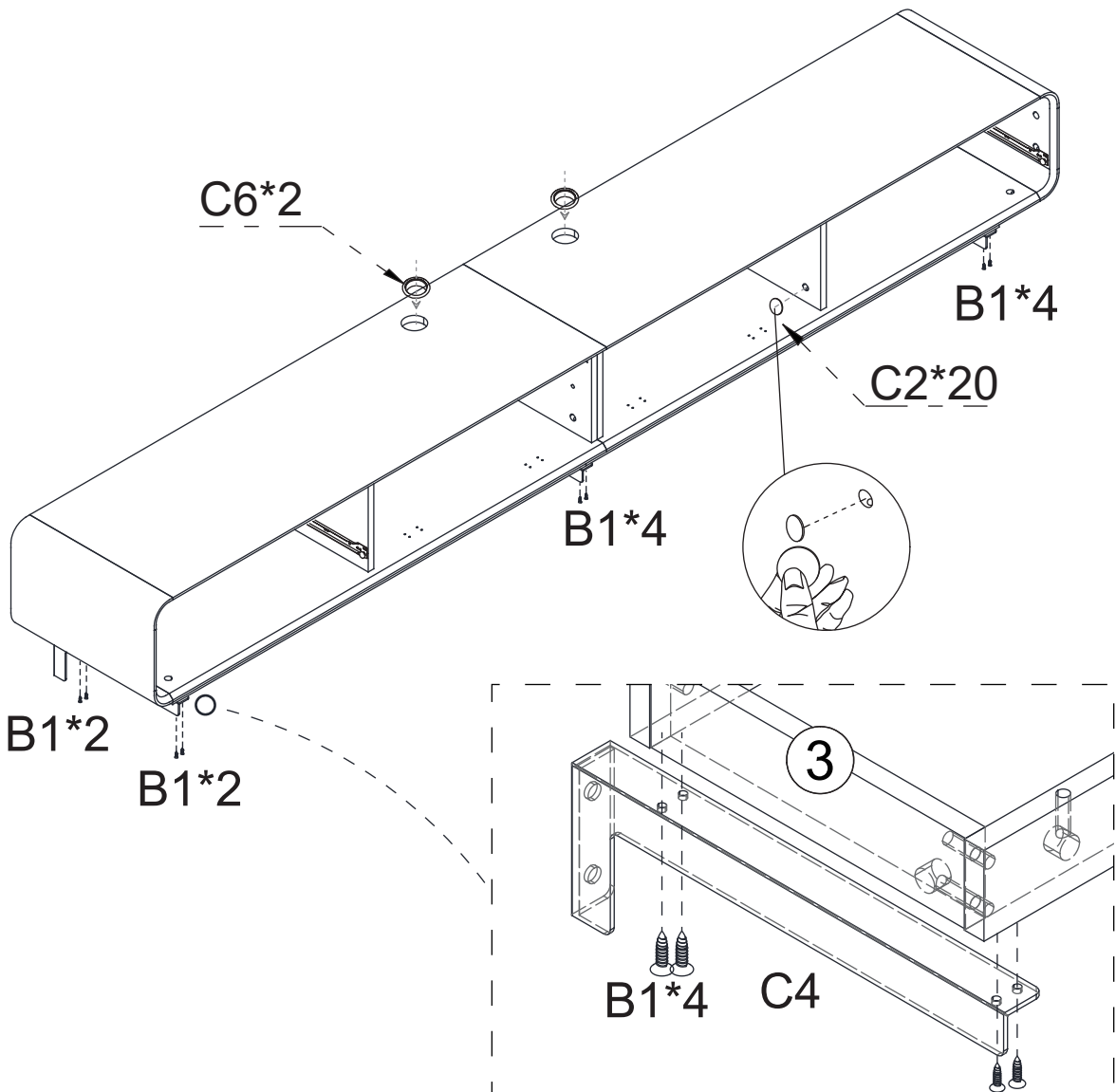

Step 22

					
B1	12PCS	C6	2PCS	C2	20PCS



Assemble

Step 23

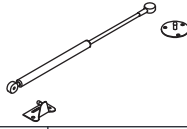
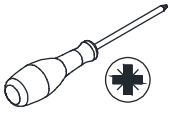
							
C7	4PCS	B1	30PCS	C8	2PCS		

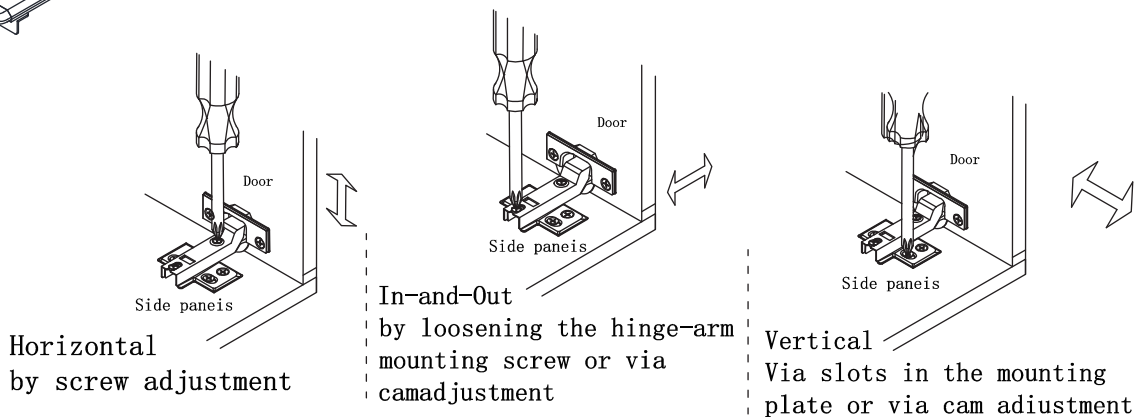
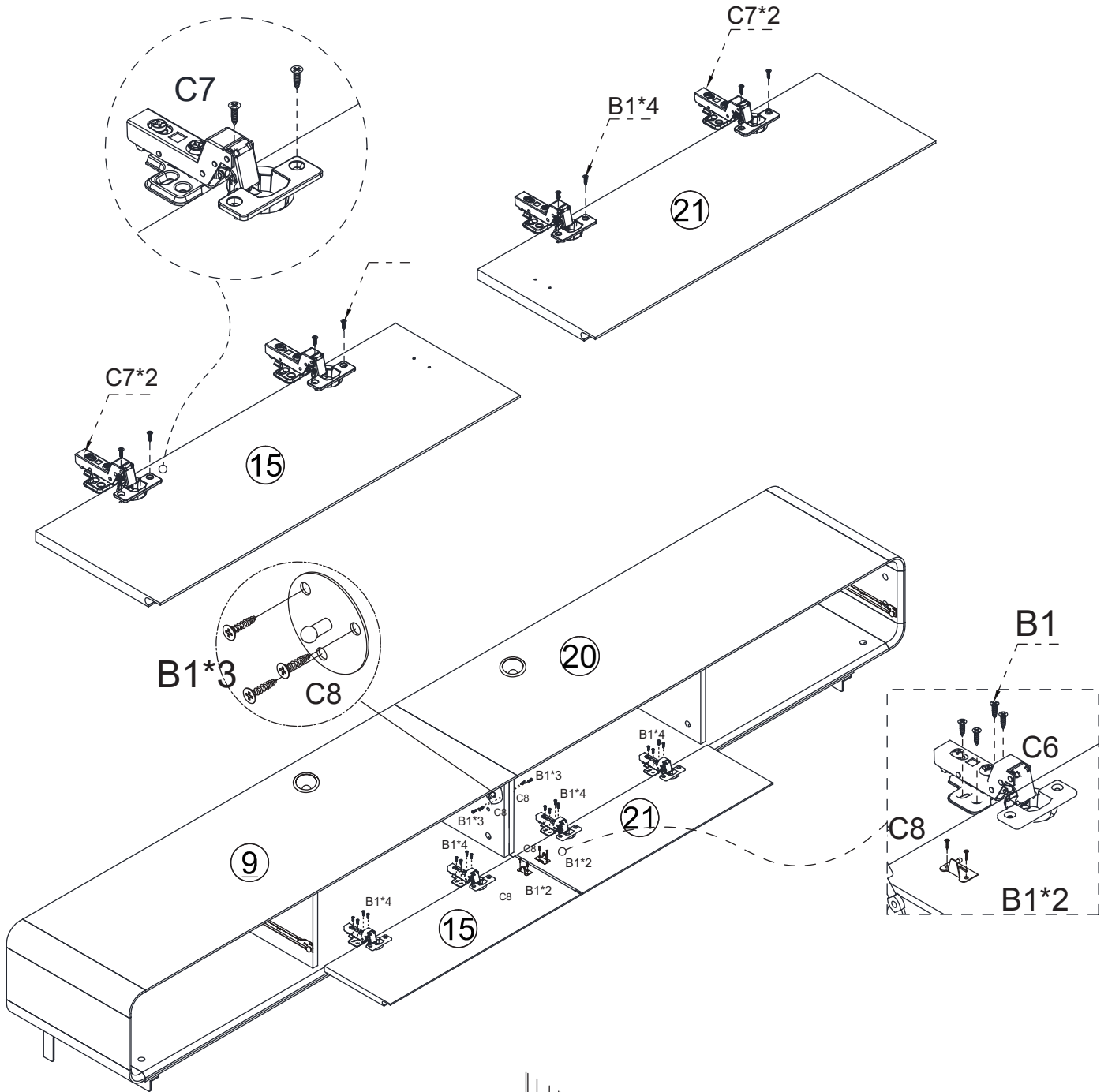

Assemble

Step 24

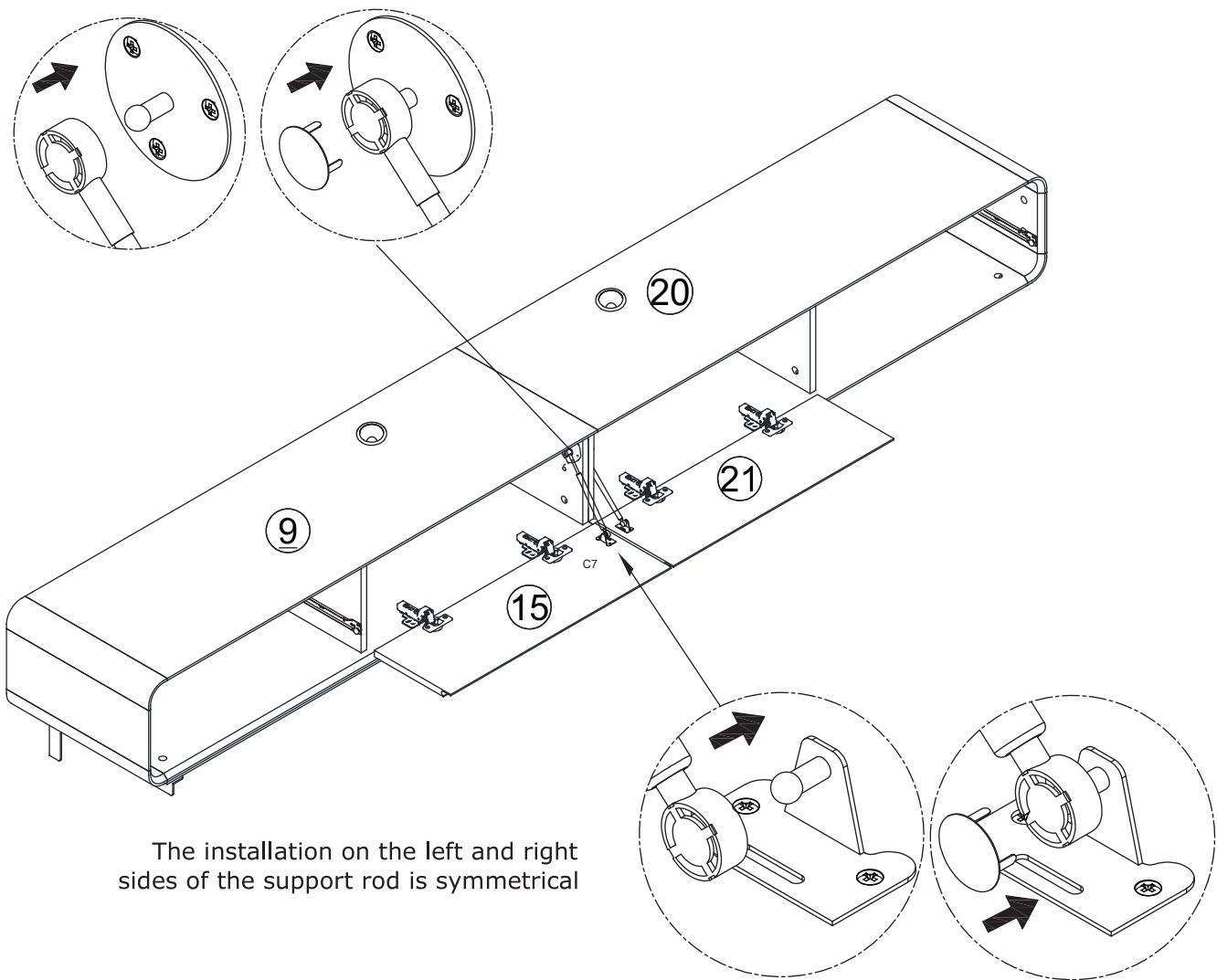
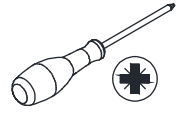

The installation on the left and right sides of the support rod is symmetrical

Assemble

Step 25

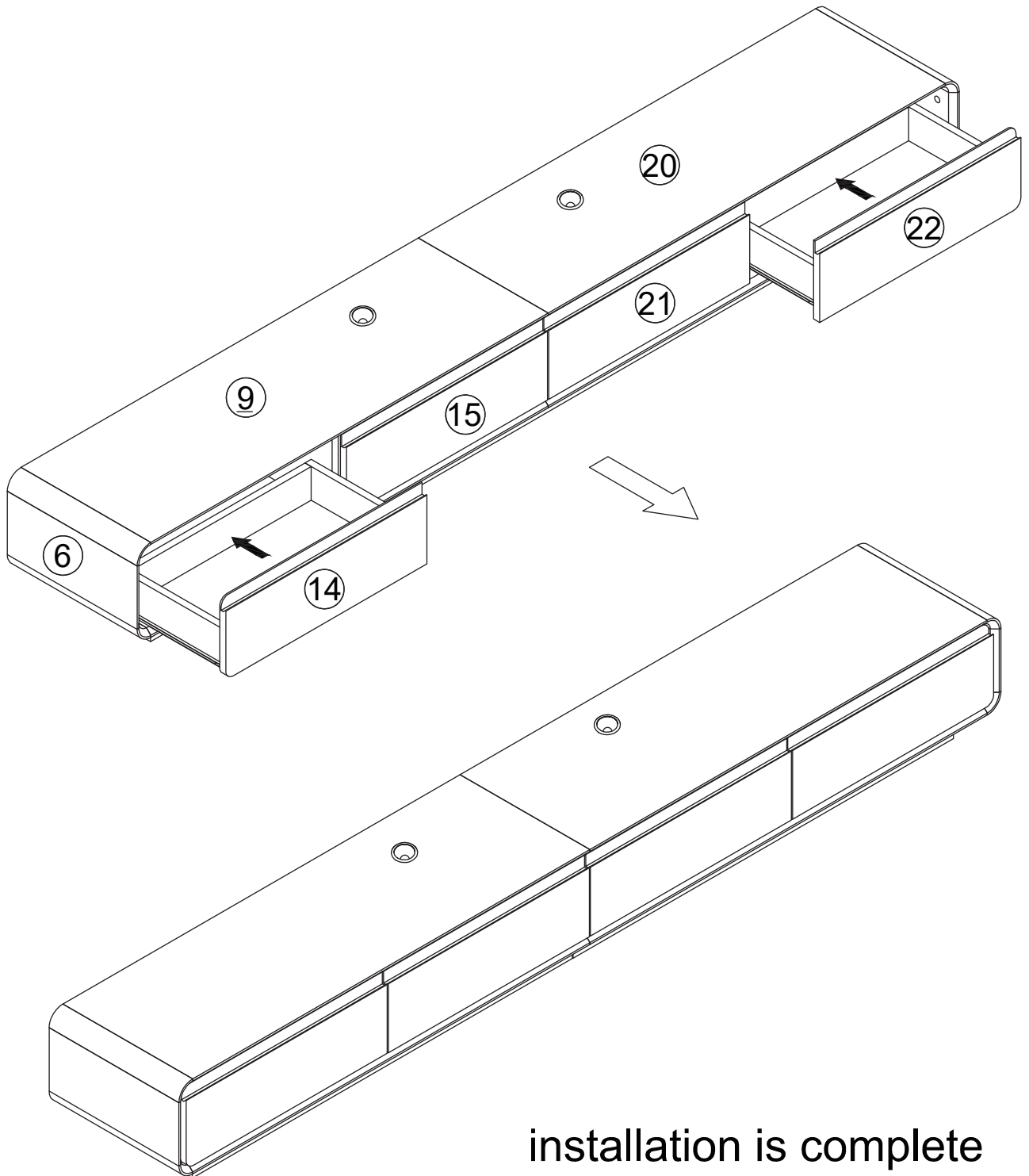
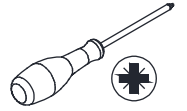

installation is complete

THIS PAGE INTENTIONALLY LEFT BLANK

THIS PAGE INTENTIONALLY LEFT BLANK

THIS PAGE INTENTIONALLY LEFT BLANK