

INSTALLATION INSTRUCTIONS

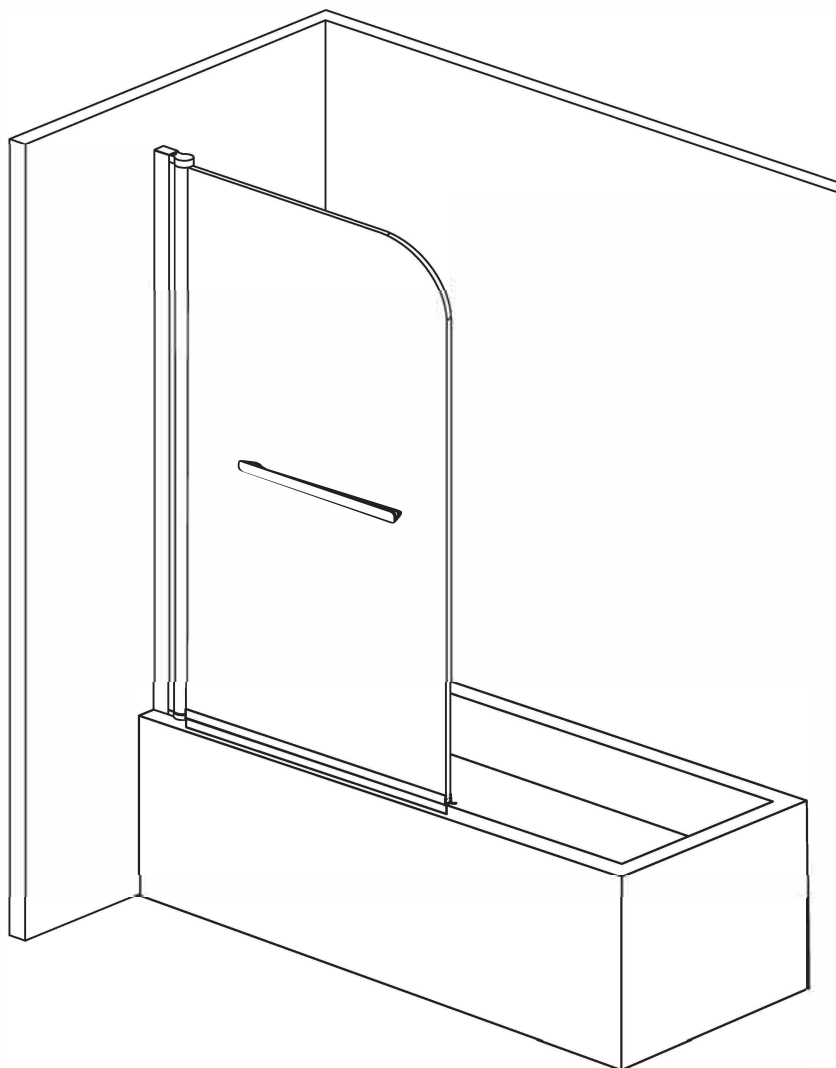

ENRO1007



◆ General Information

Please inspect the product immediately upon receipt for transit damage, missing packs/parts or manufacturing fault. Damage reported later cannot be accepted. Please handle the product with care avoiding knocks and shock loading to all sides and edges of the glass.

Notes: Safety glass can not be re-worked.

Please read these instructions carefully before start of installation.

Special care should be taken when drilling walls to avoid hidden pipes or electrical cables.

Note: This product is heavy and may require two people to install.

Aftercare instructions

After use, your shower should be cleaned with soap and water. This is particularly important in hard water districts where insoluble lime salts may be deposited and allowed to build up. Cleaners of a gritty or abrasive nature should not be used. Care should be taken to avoid contact with strong chemicals such as organic solvents and strippers.

Glass cleaners can be used but with caution, if in doubt contact the manufacturer of the cleaner in question.

Please keep these instructions for aftercare and customer service details.

It is recommended that at least two people install it.

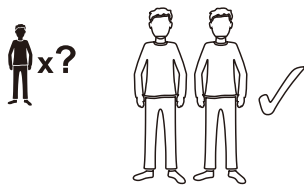

Wear gloves and goggles for your safety.

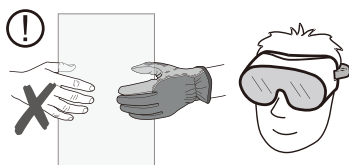

Required Tools

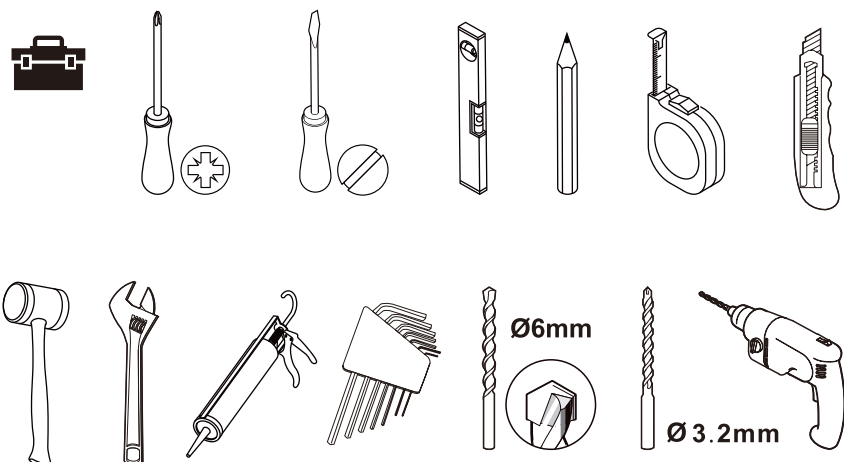

If something is missing or broken, please contact us. We will help you.



What's in the box

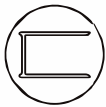

[01] x1



[02] x1

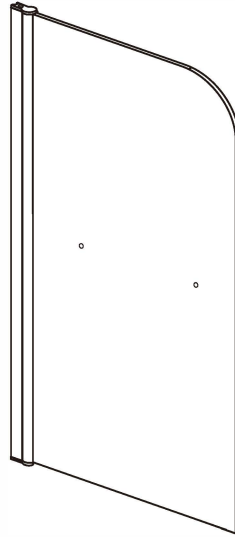

[03] x1



[04] x1



[05] x3 (ST4x35)



[06] x3 (ST4x8)



[07] x3



[08] x3



[09] x1

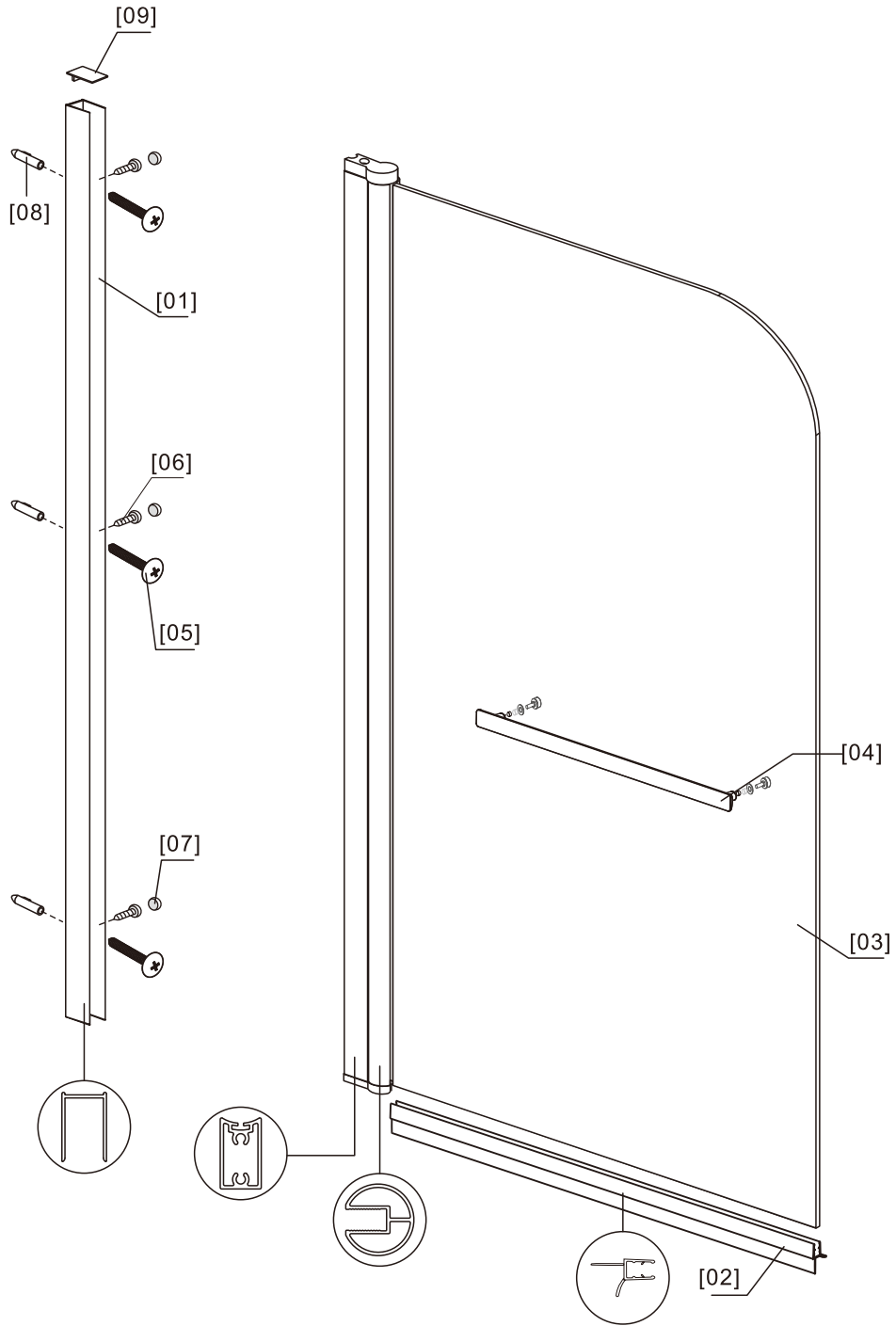

1. Place [01] the wall post against the wall. Make sure [01] the wall post is at least 10MM away from the edge.
2. Use a pencil to mark the drill holes on the wall. Drill the holes according to your marks.
3. Knock [08] the wall plugs into the wall, then use [05] ST4×35 screw the wall post in place.



01

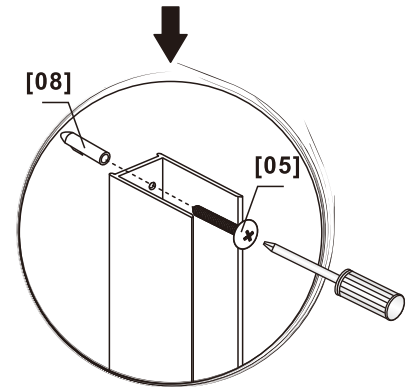
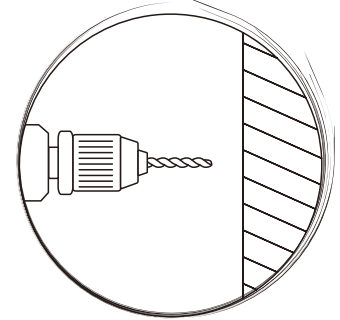
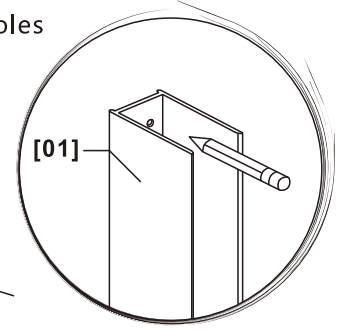
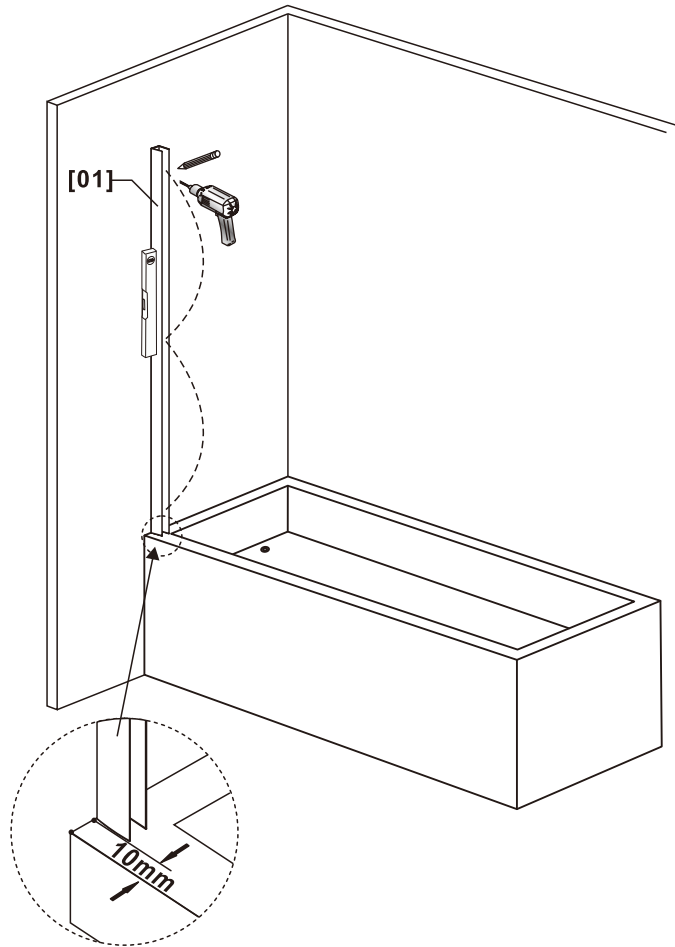
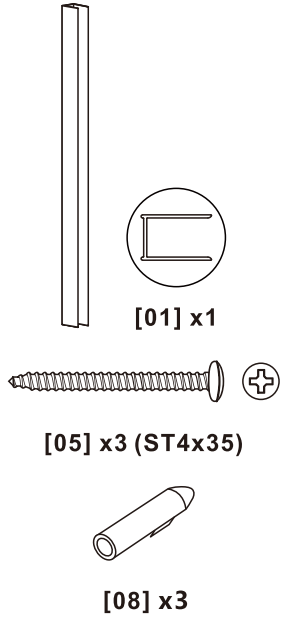

Put [03] glass into the wall post.

02

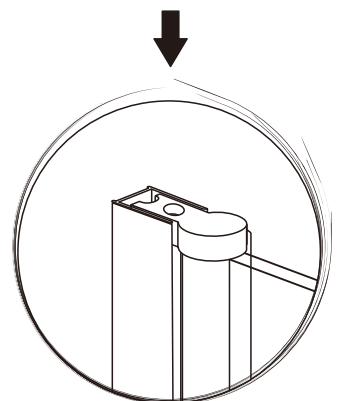
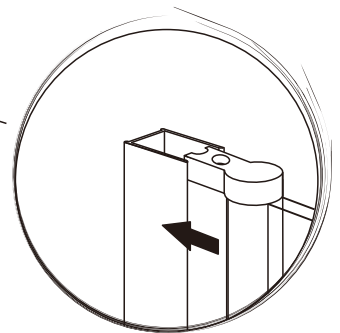
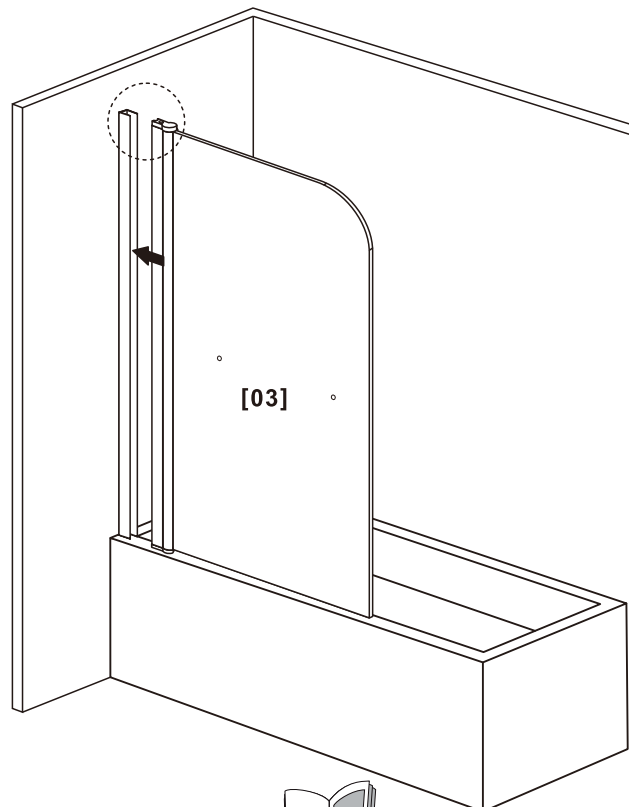
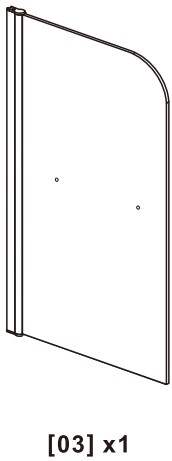

03



[02] x1

Insert [02] the seal strip onto the bottom.

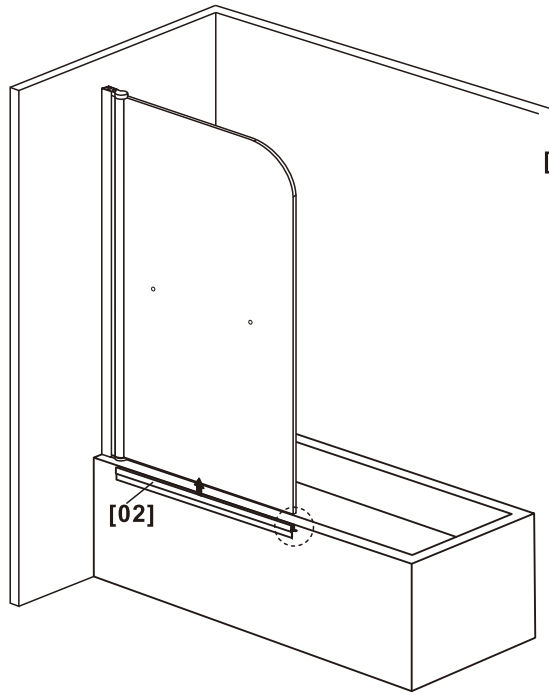

[02]

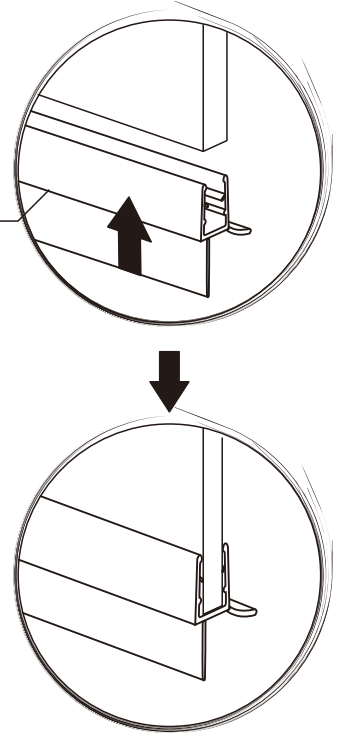

04



[06] x3 (ST4x8)



[07] x3

1. Drill holes using a 3.2mm diameter drill bit.
2. Screw [06] in place.
3. Put [07] cover cap on [06].

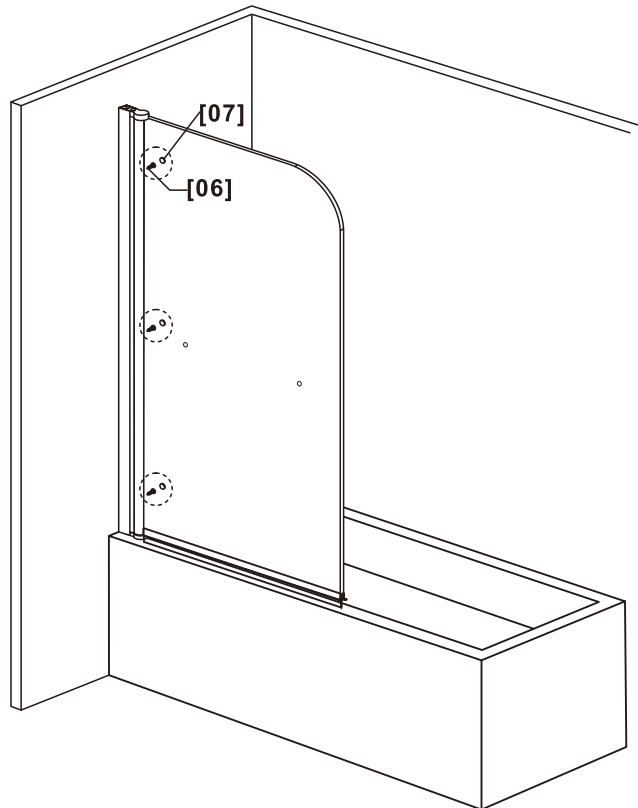

[07]

[06]

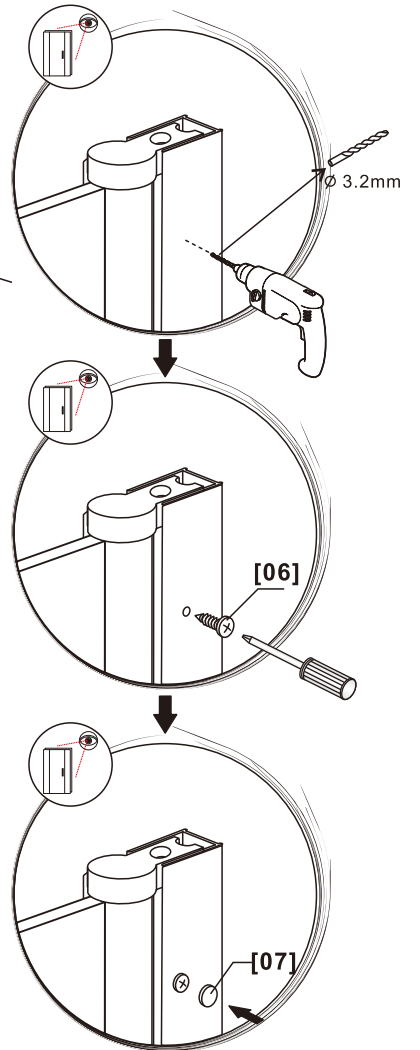

Ø 3.2mm

[06]

[07]

05

1. Put [09] cover on the top.
2. Assemble [04] towel bar.



[04] x1



[09] x1

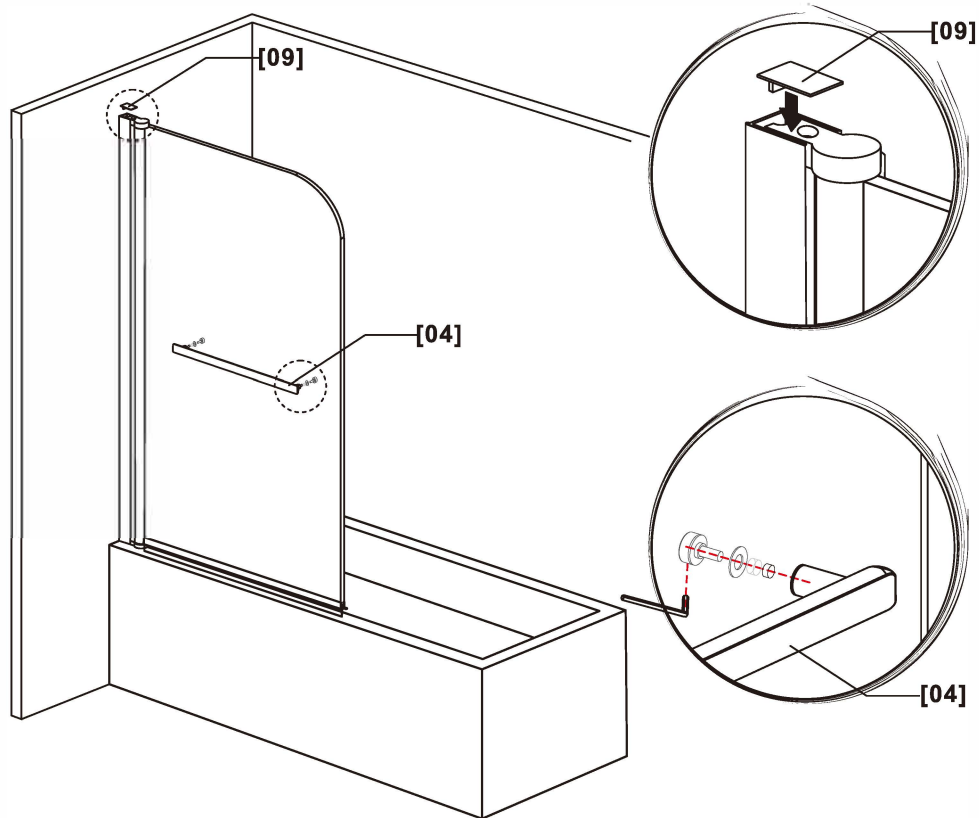

06

Apply enough waterproof glue to the dotted line.

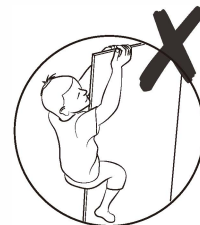
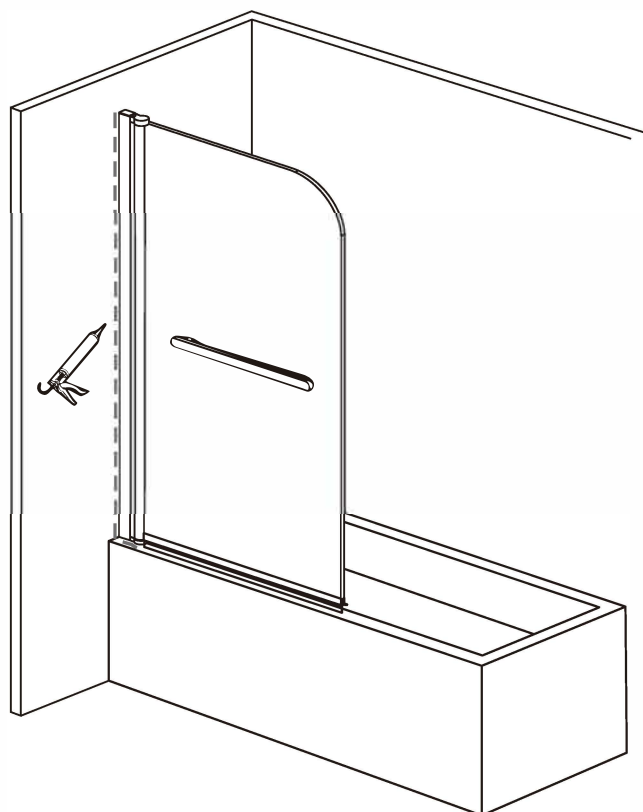

Keep out of water and use for 24 hours.