

Bookcase 8 Cubes > Manual

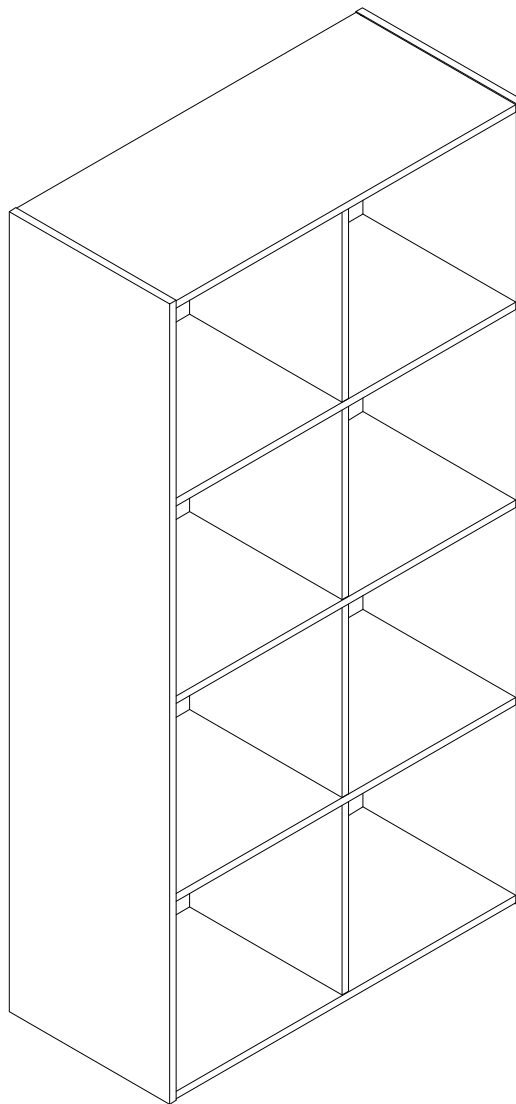

Thank you for purchase on our products. Please contact us if you have difficulty with assembly or need replacement parts. Our customer service is here to assist you. Please attach your User Name or Order ID so that we can assist you better.

Vielen Dank für Ihren Kauf von uns Produkten. Bitte kontaktieren Sie uns, wenn Sie Probleme mit Montage haben oder Ersatzteile benötigen. Wir Kundenservice ist für Sie da. Bitte geben Sie Ihren Benutzernamen oder Ihre Bestellnummer an, damit wir Sie besser unterstützen können.

EN

WARNING

Serious or fatal injury may occur from unexpected assembly or use.

1. During the assembly process, keep all parts away from babies or children.
2. Always securely fix this product to the wall. Make sure the wall area to be drilled is free from hidden electrical wires, water and gas pipes.
3. Use of tip-over restraints may only reduce, but not eliminate the risk of tip-over.
4. Unless specially designed to accommodate, do not set heavy objects on top of this product.
5. Place the heaviest items on the lowest shelf.
6. Never allow children to climb or bang on drawers, doors or shelves.

DE

WARNUNG







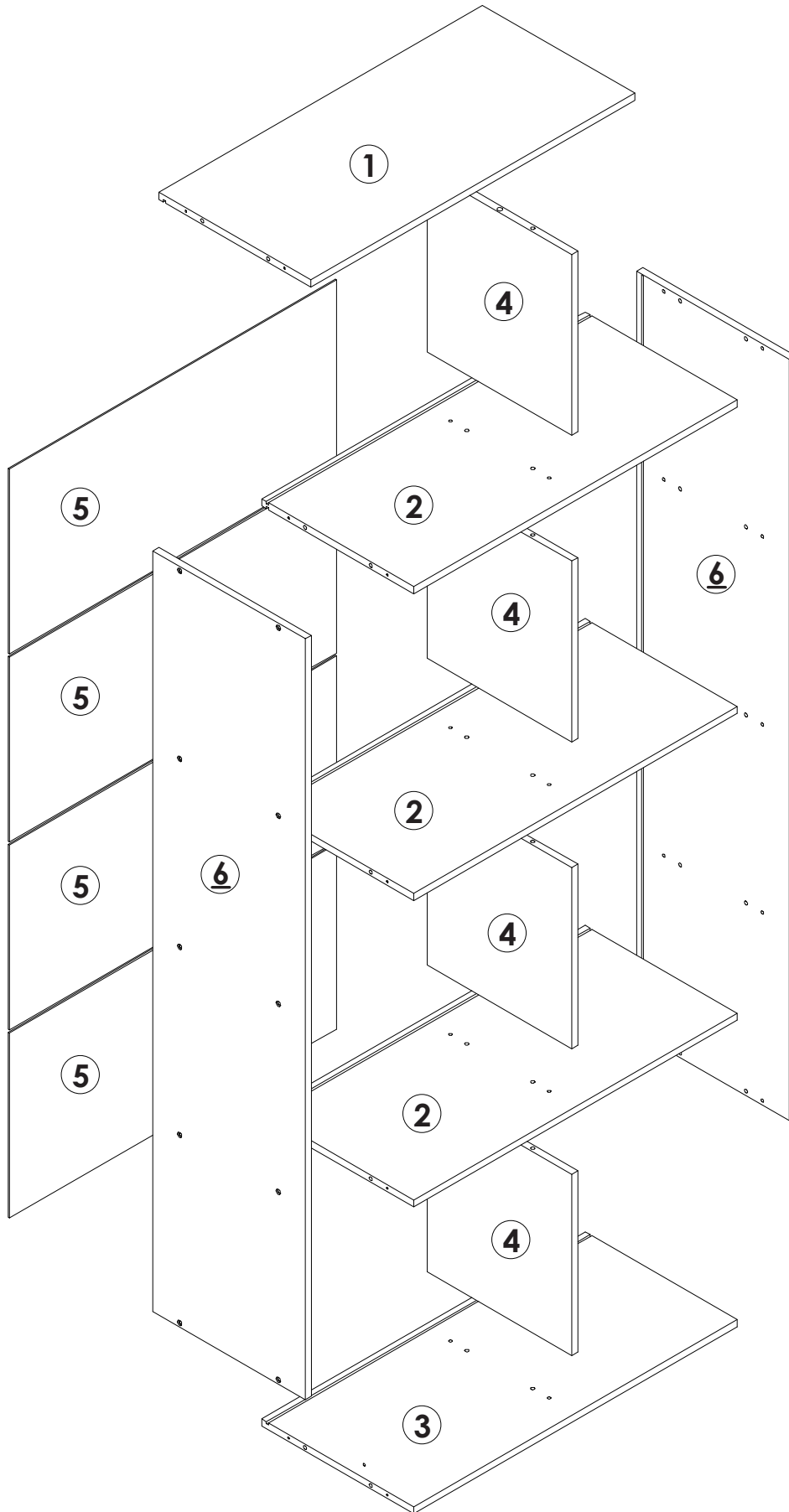

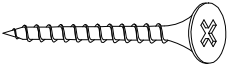

Bei unerwarteter Montage oder Verwendung können schwere oder tödliche Verletzung auftreten.

1. Legen Sie in den Montageprozess alle Teile weg von Babys oder Kindern.
2. Stellen Sie sicher, dass der gebohrte Wandbereich frei von verborgenen Stromkabeln, Wasser- und Gasleitungen ist, wenn Sie dieses Produkt an der Wand befestigen.
3. Die Verwendung von Kippsicherungen kann die Gefahr eines Kippens nur verringern, jedoch nicht beseitigen.
4. Setzen Sie bitte keine schweren Gegenstände auf dieses Produkt, es sei denn, dass das Produkt speziell für die Unterbringung konzipiert wird.
5. Legen Sie bitte die schwersten Gegenstände auf das unterste Regal.
6. Erlauben Sie nie Kindern, auf Schubladen, Türen oder Regale zu klettern oder zu knallen.

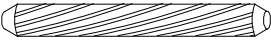
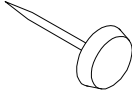
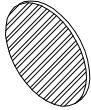
Parts List(EN) / Teile Liste(DE)



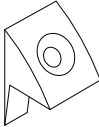

Parts List(EN) / Teile Liste(DE)

<p>A</p> <div style="text-align: center; margin: 10px 0;">  </div> <div style="display: flex; justify-content: space-between; margin-top: 10px;"> M6×35mm 4PCS </div>	<p>B</p> <div style="text-align: center; margin: 10px 0;">  </div> <div style="display: flex; justify-content: space-between; margin-top: 10px;"> Ø15×9mm 4PCS </div>	<p>C</p> <div style="text-align: center; margin: 10px 0;">  </div> <div style="display: flex; justify-content: space-between; margin-top: 10px;"> M4×35mm 28+2PCS </div>
<p>D</p> <div style="text-align: center; margin: 10px 0;">  </div> <div style="display: flex; justify-content: space-between; margin-top: 10px;"> Ø6×30mm 24+2PCS </div>	<p>E</p> <div style="text-align: center; margin: 10px 0;">  </div> <div style="display: flex; justify-content: space-between; margin-top: 10px;"> Ø6×50mm 6PCS </div>	<p>F</p> <div style="text-align: center; margin: 10px 0;">  </div> <div style="display: flex; justify-content: space-between; margin-top: 10px;"> 4PCS </div>
<p>G</p> <div style="text-align: center; margin: 10px 0;">  </div> <div style="display: flex; justify-content: space-between; margin-top: 10px;"> Ø20mm 24+2PCS </div>	<p>H</p> <div style="text-align: center; margin: 10px 0;">  </div> <div style="display: flex; justify-content: space-between; margin-top: 10px;"> M3×14mm 10+1PCS </div>	<p>I</p> <div style="text-align: center; margin: 10px 0;">  </div> <div style="display: flex; justify-content: space-between; margin-top: 10px;"> 4PCS </div>
<p>J</p> <div style="text-align: center; margin: 10px 0;">  </div> <div style="display: flex; justify-content: space-between; margin-top: 10px;"> 2PCS </div>	<p>K</p> <div style="text-align: center; margin: 10px 0;">  </div> <div style="display: flex; justify-content: space-between; margin-top: 10px;"> 2PCS </div>	<p>L</p> <div style="text-align: center; margin: 10px 0;">  </div> <div style="display: flex; justify-content: space-between; margin-top: 10px;"> M4×40mm 2PCS </div>
<p>M</p> <div style="text-align: center; margin: 10px 0;">  </div> <div style="display: flex; justify-content: space-between; margin-top: 10px;"> 8+1PCS </div>		

Assembly Steps(EN) / Montageschritte(DE)

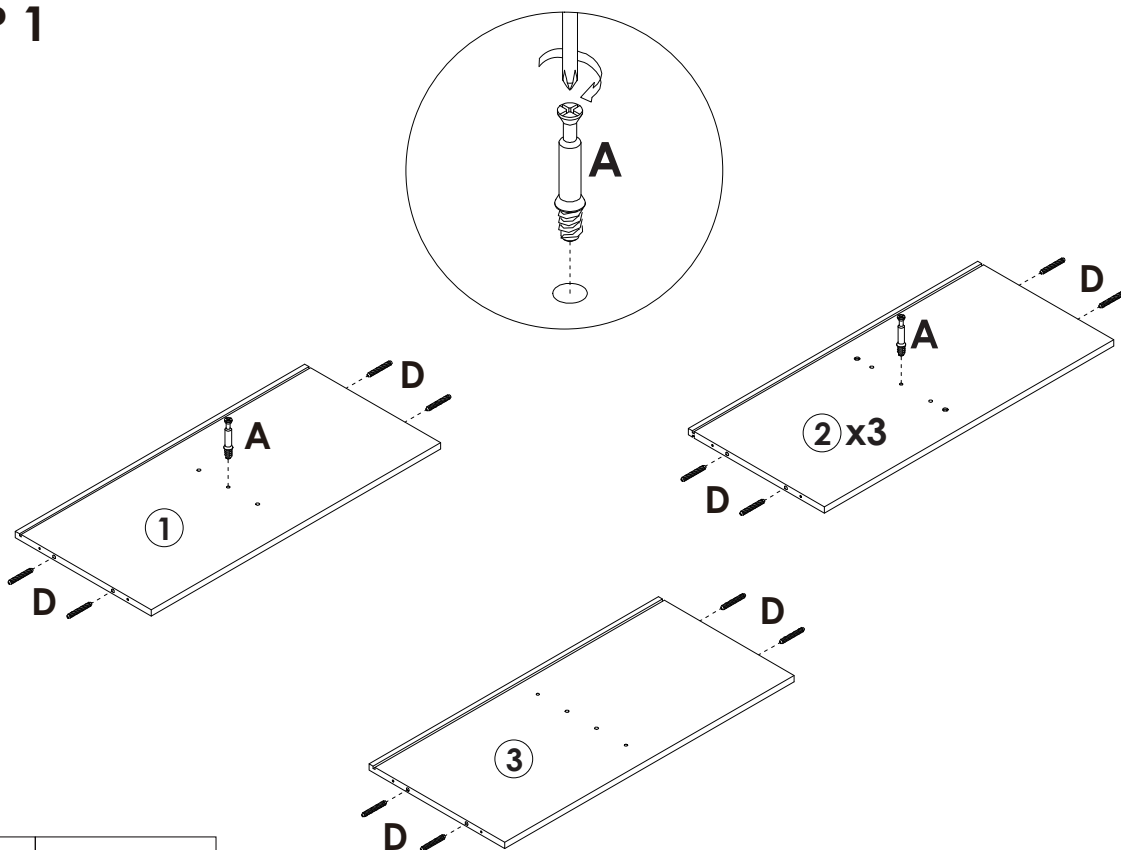
STEP 1

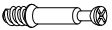

	A x 4PCS
	D x 20PCS

STEP 2

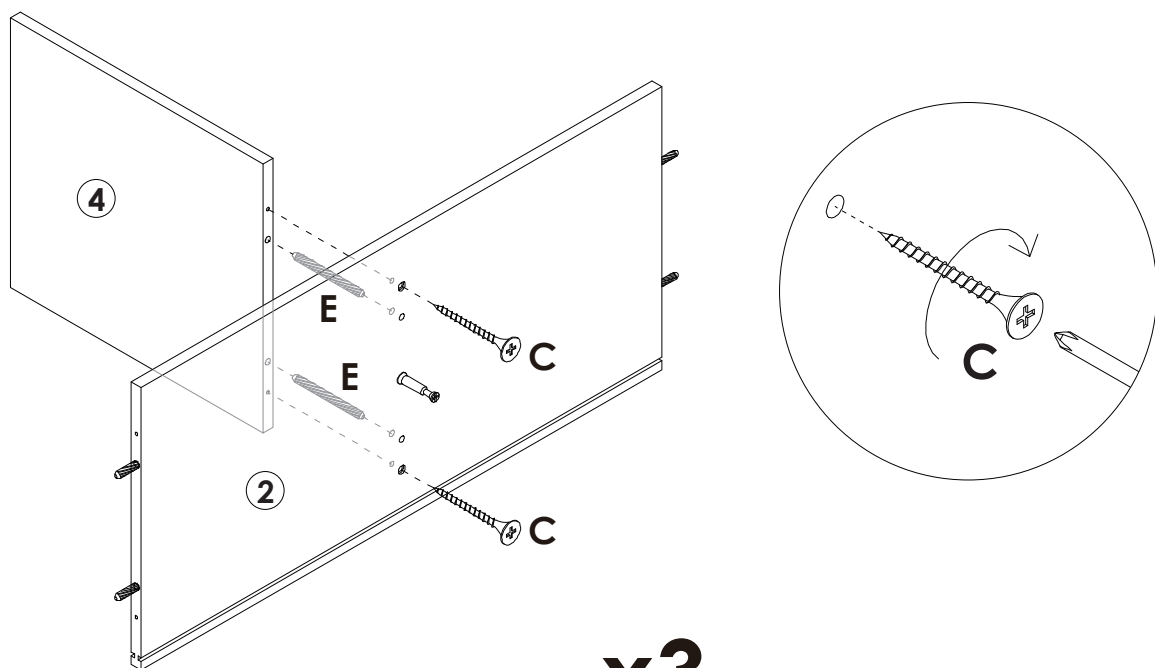



x3

	C x 6PCS
	E x 6PCS

Assembly Steps(EN) / Montageschritte(DE)

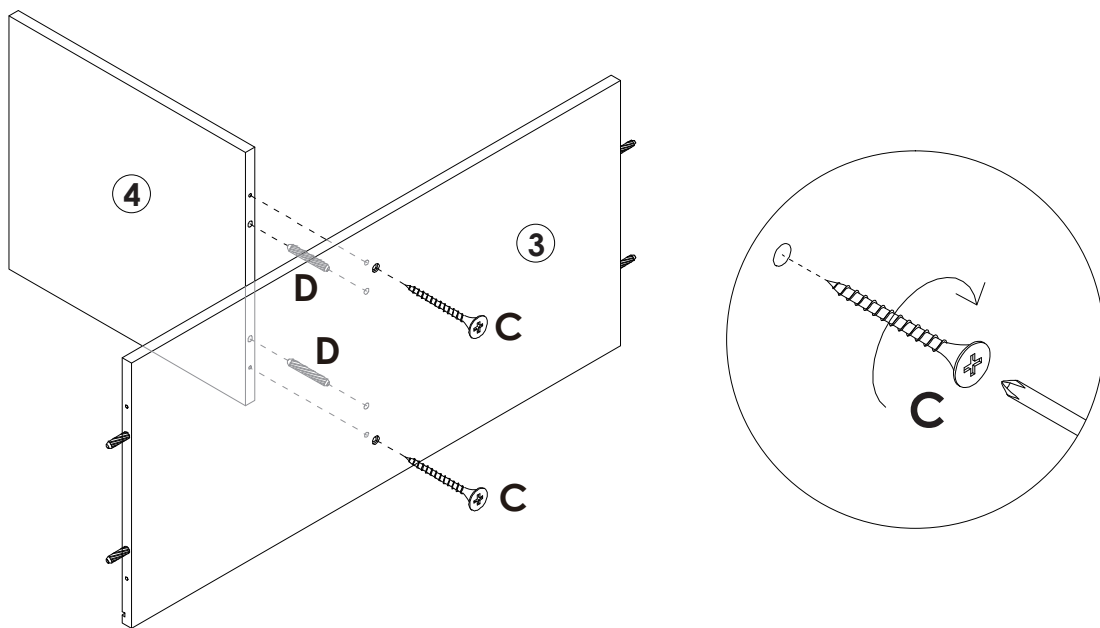

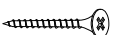
STEP 3

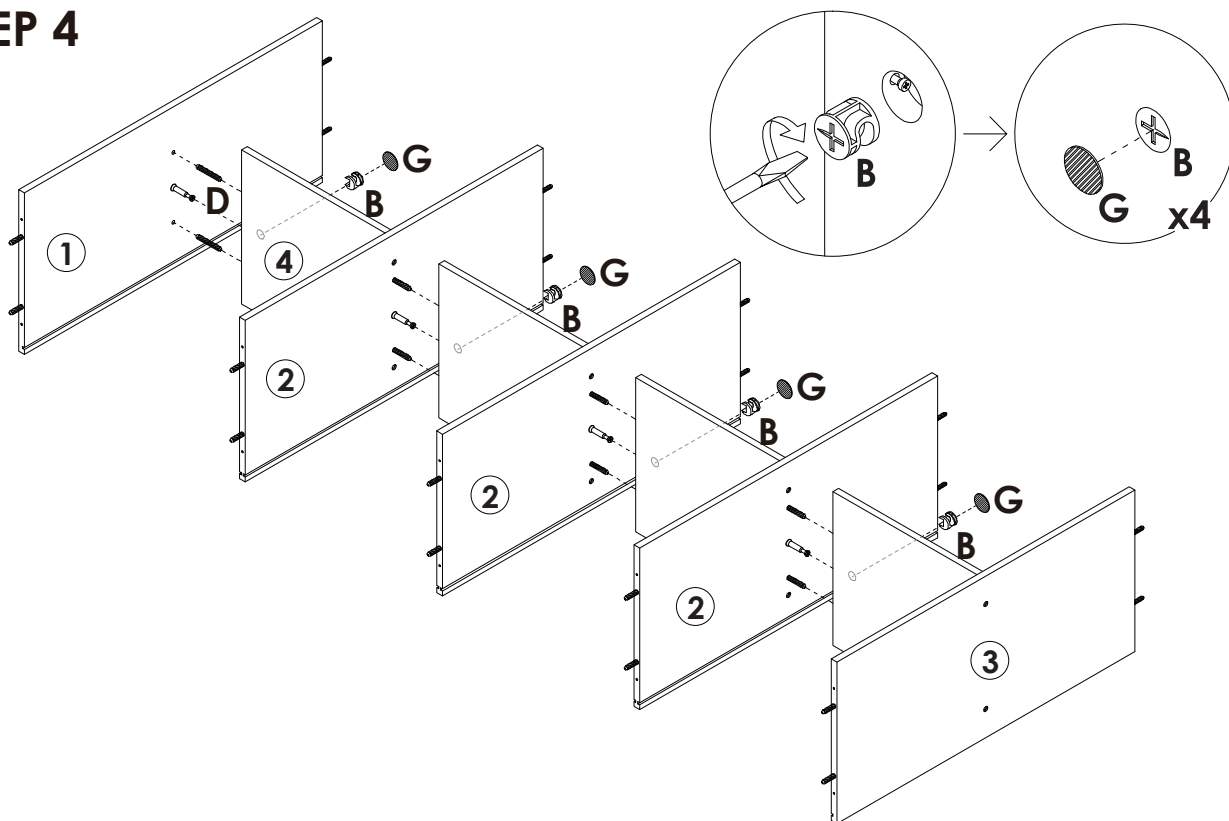

	C x 2PCS
	D x 2PCS

STEP 4



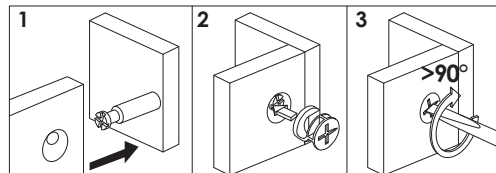

	B x 4PCS
	D x 2PCS
	G x 4PCS

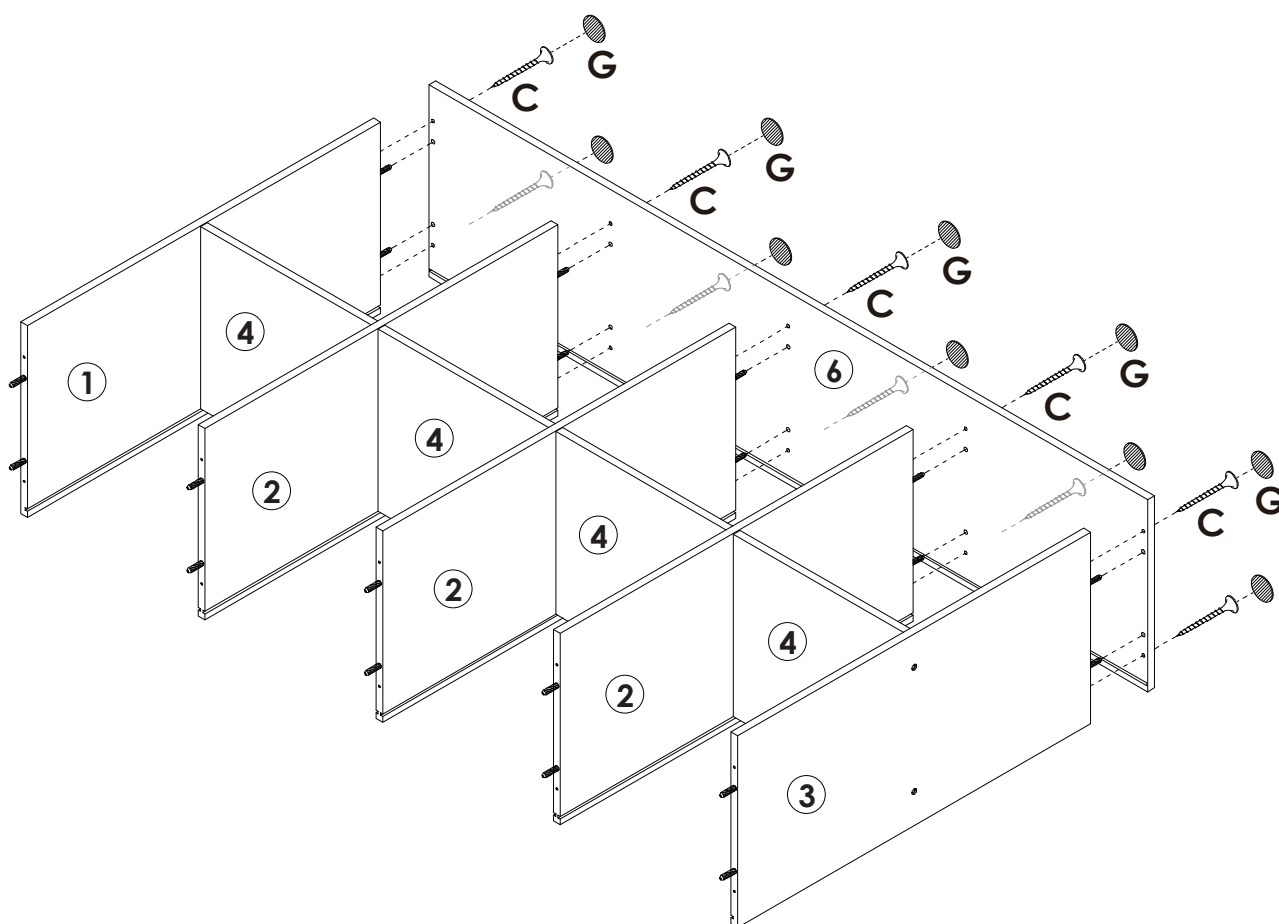
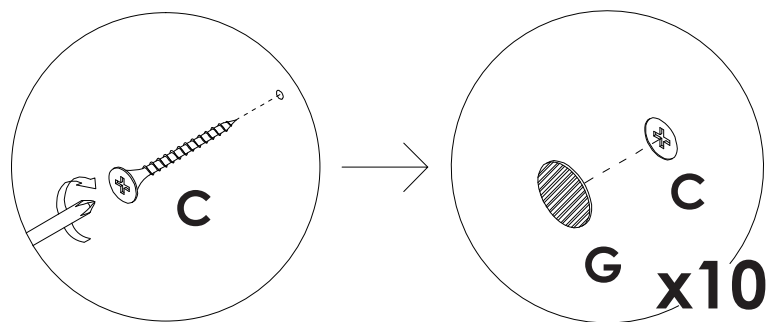

Assembly Steps(EN) / Montageschritte(DE)

STEP 5

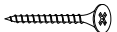

	C x 10PCS
	G x 10PCS

Assembly Steps(EN) / Montageschritte(DE)

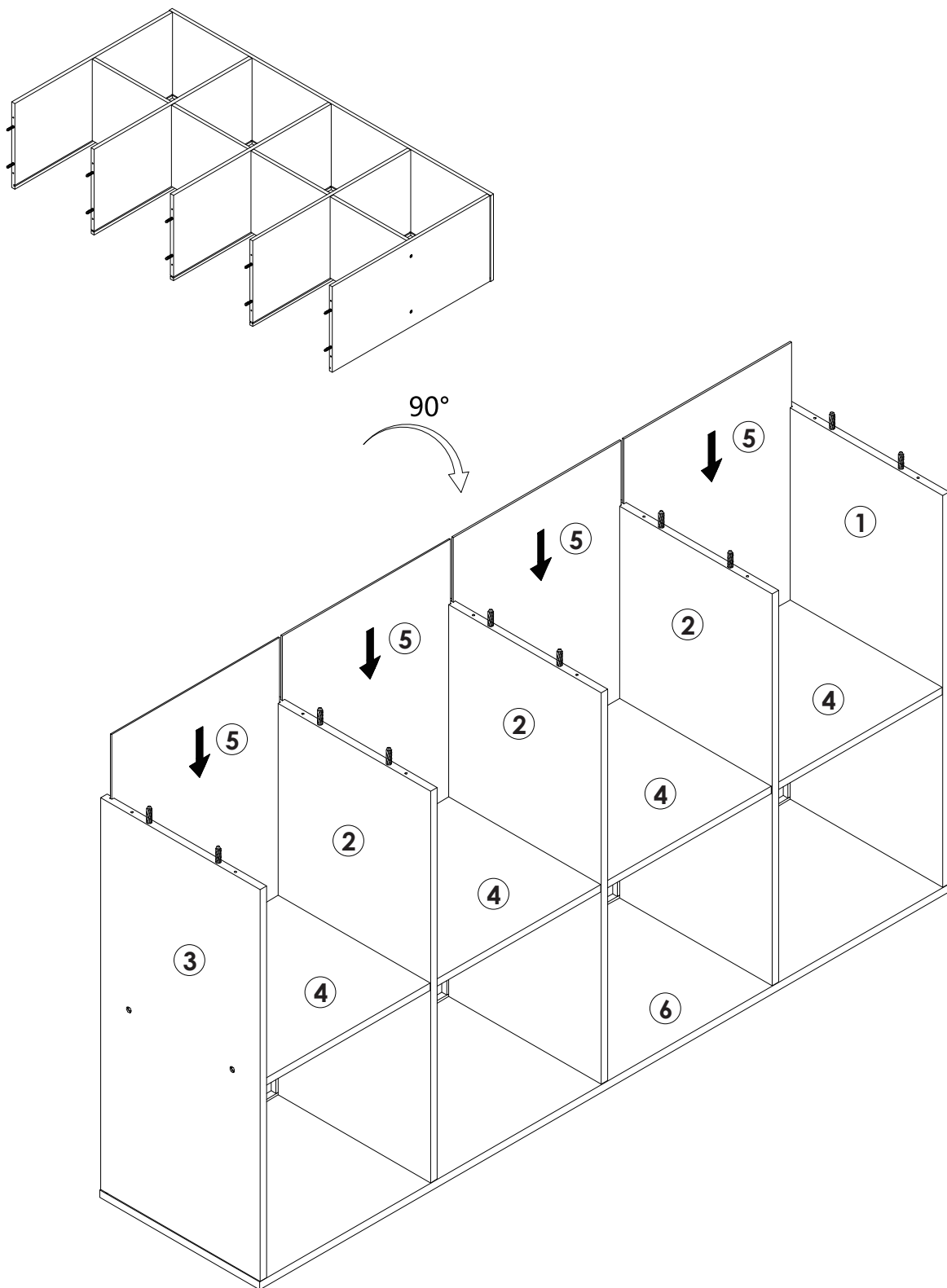

STEP 6

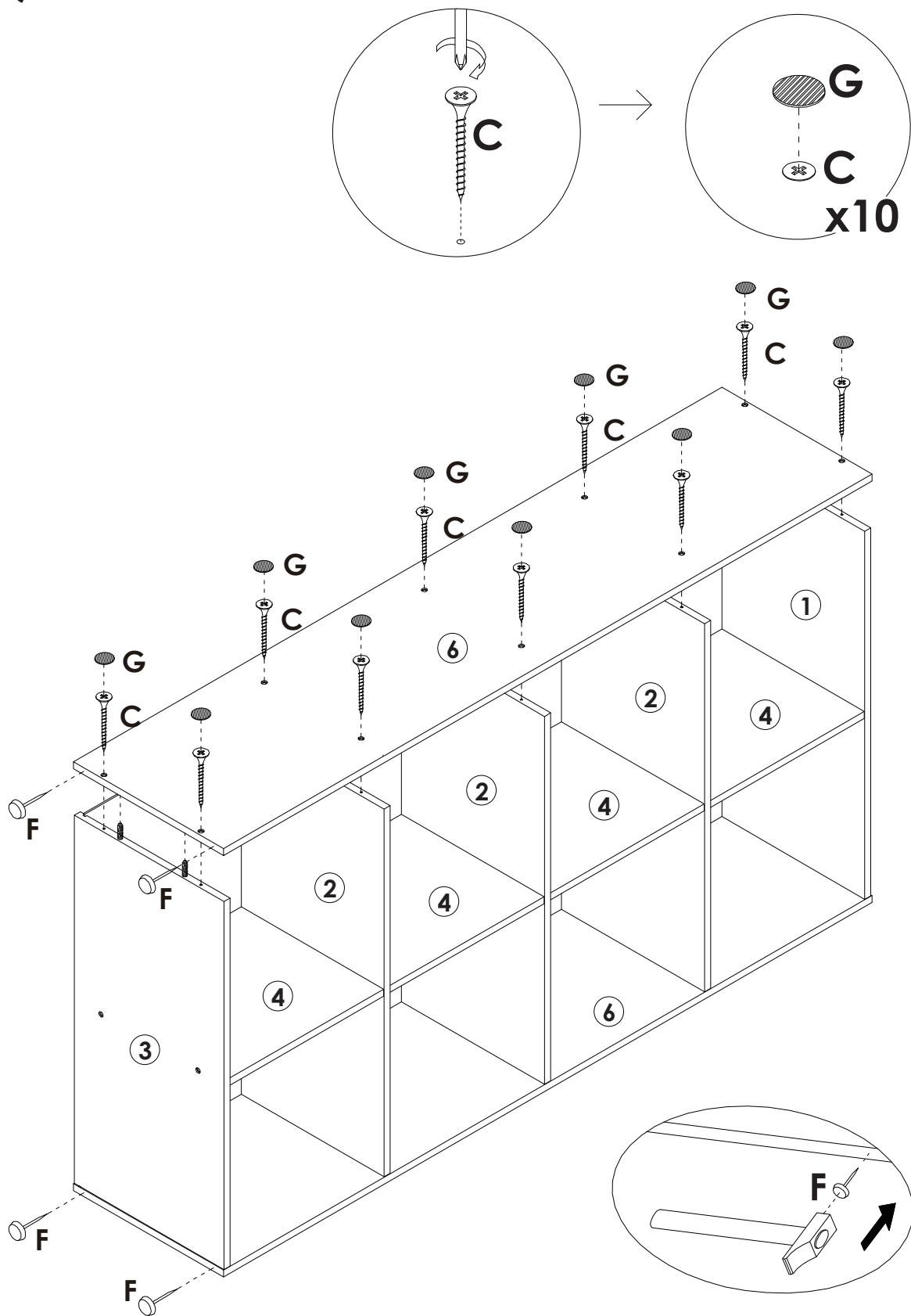

Assembly Steps(EN) / Montageschritte(DE)

STEP 7

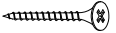





	C x 10PCS
	G x 10PCS
	F x 4PCS

Assembly Steps(EN) / Montageschritte(DE)

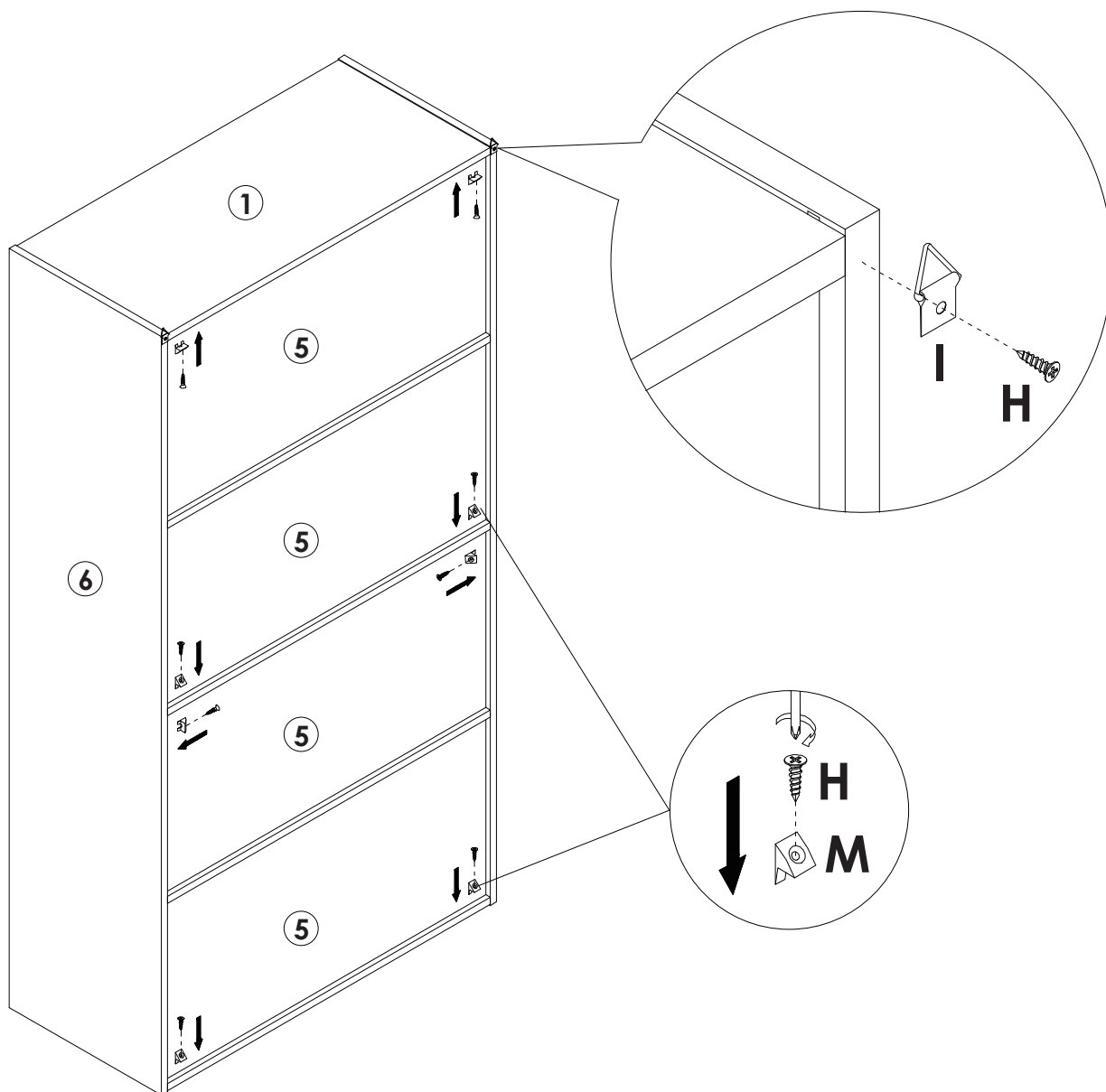
STEP 8

Use the "H" screw to lock the "I" Part on the back of the "6" board.







	H x 10PCS
	M x 8PCS
	I x 2PCS

Assembly Steps(EN) / Montageschritte(DE)

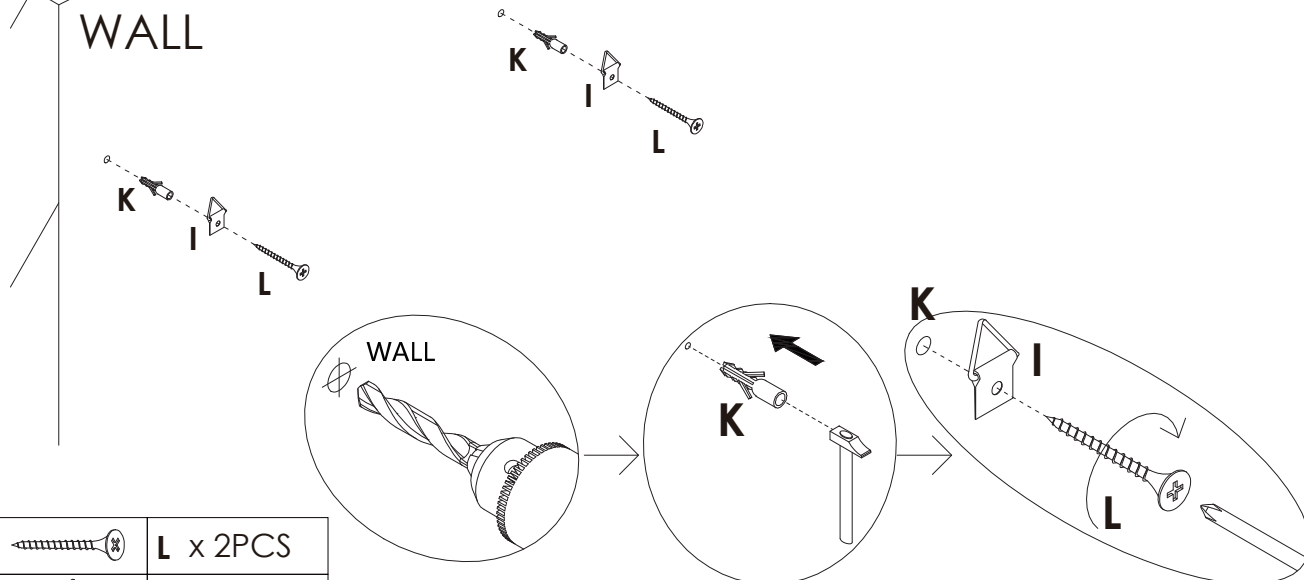
STEP 9

After installation, move the cabinet to the position you need, and drill 2 holes on the wall at the corresponding position according to the height and position of the anti-falling device. Firstly, put the plastic screws "K" into 2 holes separately, and then use the "L" screws to lock the Parts "I" with the plastic screws "K" separately.



	L x 2PCS
	I x 2PCS
	K x 2PCS

STEP 10

After that, move the cabinet to the corresponding position, then use the part "J" to pass through the part "I", and tighten it. The installation of the anti-falling device is completed.

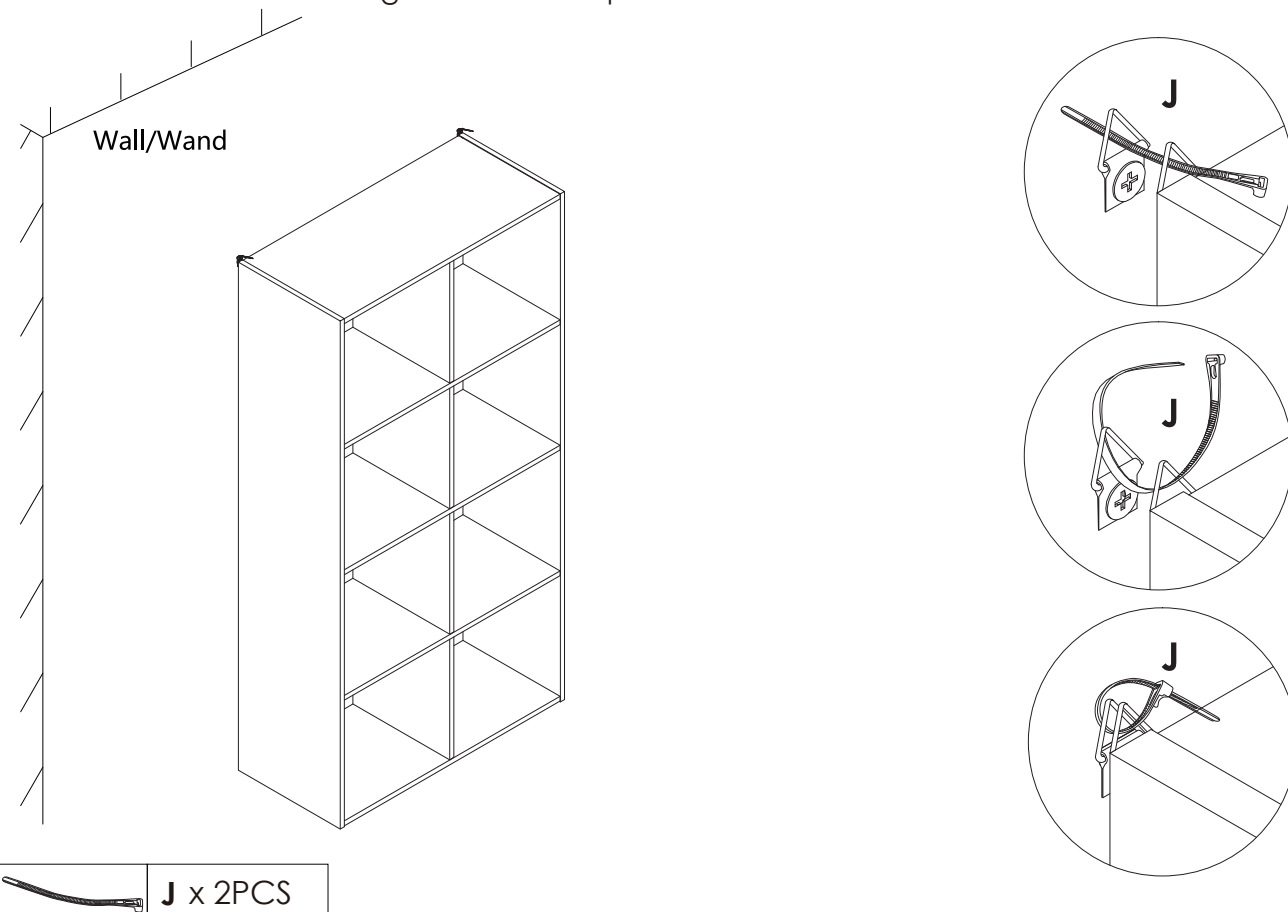

	J x 2PCS
---	----------



WARNING



Children have died from furniture tipover. To reduce the risk of furniture tipover:

- **ALWAYS** install tipover restraint provided.
- **NEVER** put a TV on this product.
- **NEVER** allow children to stand, climb or hang on drawers, doors, or shelves.
- **NEVER** open more than one drawer at a time.
- Place heaviest items in the lowest drawers.

