

INSTRUCTIONS

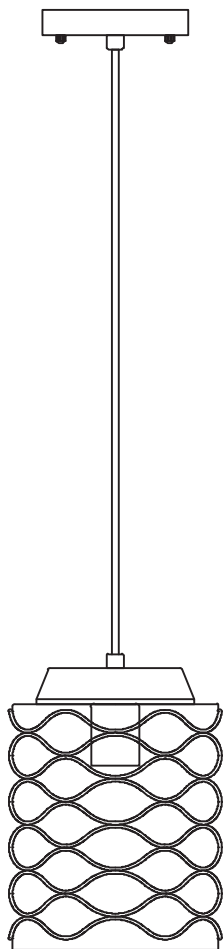

MADE IN CHINA

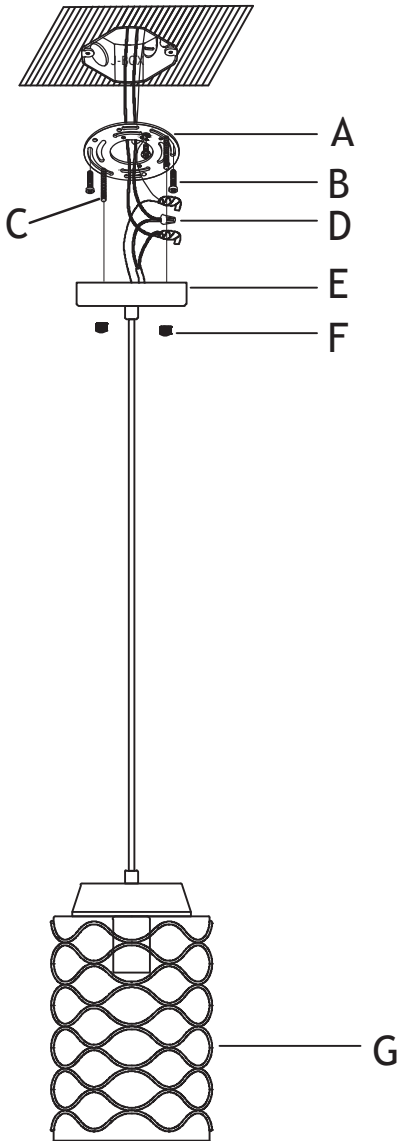

A. Mounting Bracket

B. Tapping Screws

C. Bracket Screws

D. Wiring Cap

E. Canopy

F. Knurled Nut

G. Lamp Body

**PLEASE READ INSTRUCTIONS IN THEIR ENTIRETY
PRIOR TO ASSEMBLY AND INSTALLATION.**

SAFETY PRECAUTIONS:

- a. Please carefully examine the cord, lamp holder, switch, and all other parts for damages. If any damage or defect is found, please return this fixture.
- b. This fixture uses E26 Medium Bulbs Max. 60W. To avoid the risk of fire, do not use bulbs that exceed the 60W limit. We suggest using LED Bulbs for lower energy consumption and longer life span.
- c. Installing this fixture requires connecting electrical wires, these connections must be in accordance with, we suggest National Electrical Code(NEC) standards, we suggest hiring a licensed electrician to do this.
- d. Recommended for indoor use only, please keep this fixture away from water or moisture.
- e. Wipe clean using a soft, dry cloth or static duster. Always avoid the use of harsh chemicals and abrasives to clean fixture as they may damage the finish.

ASSEMBLY & INSTALLATION GUIDE

ITEMS YOU NEED

- a. Ladder
- b. Screwdriver
- c. Wire cutter/stripper
- d. Insulation tape
- e. 1 × E26 Bulbs(<60W)

GETTING STARTED

1. Carefully unpack all accessories and parts.
2. Place all components on a clean, flat and soft surface to prevent parts from getting scratched.
3. Shut off your main electrical supply at the fuse box or circuit breaker. Just turning off the light switch is not sufficient to prevent electrical shock!

1

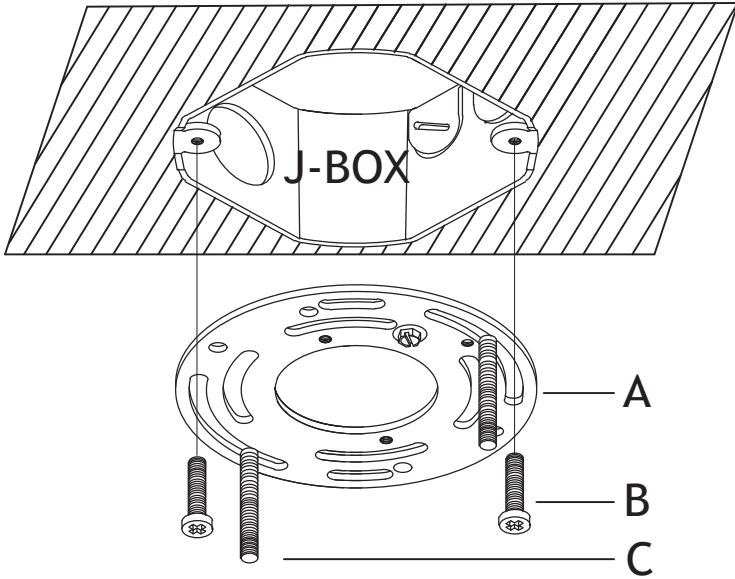

Step 1.
Secure Mounting Bracket(A) to ceiling junction box by
Tapping Screws(B).

2

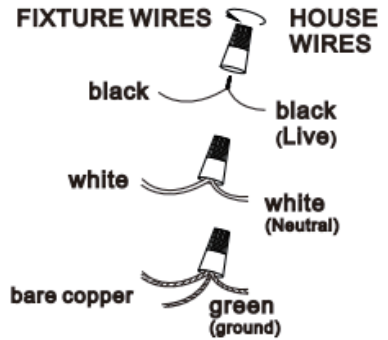
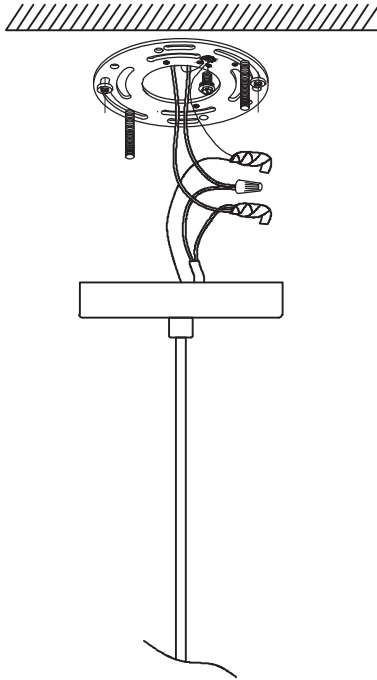

Step 2.

1. Connect black fixture wire to black supply wire and white fixture wire to white supply wire using wire caps(provided).Wrap connection with electrical tape.
2. Connect ground wire from canopy with ground wire from Junction box using a wire cap. Wrap with electrical tape for a more secure connection. If house does not have ground wire, attach grounding wire to green grounding screw marked GND.
3. Tuck all wires carefully into the J-Box.

WARNING:

Never connect grounding wire to black or white power supply wires. It is imperative that the outlet box in your home be properly grounded.

3

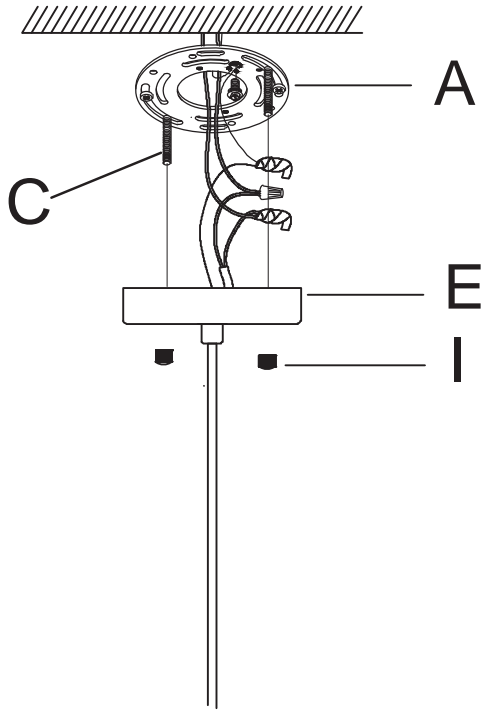

Step 3.

Secure the canopy(E) to the mounting bracket (A) with the knurled nut (I).

4

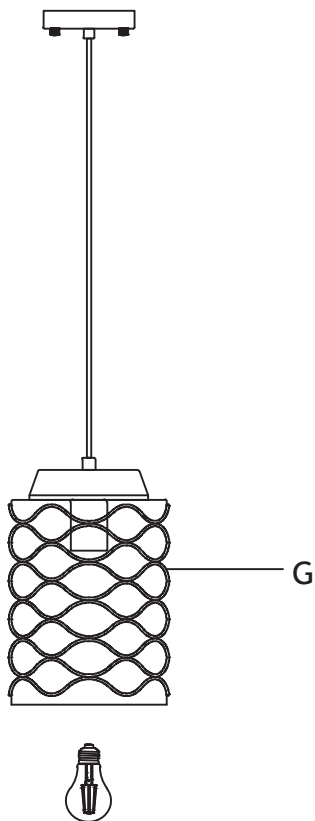

Step 4.
Turn the bulb(not included)
clockwise into the lamp body(G).