











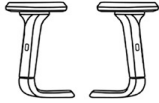



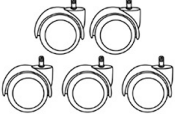

## Accessories List

(1) Backrest 	(2) Seat Cushion 	(3) Headrest 	(4) 2 Armrests 
(5) Air Rod 	(6) Central Base Tube 	(7) 5 Split Base Tubes 	(8) 5 Castors 
(9) Base Plate 	(10) Keel 	(11) Decorative Cover 	(12) 10 Screws (M6X12mm) 
(13) 4 Screws (M6X20mm) 	(14) 3 Screws (M8X35mm) 	(15) 3 Screws (M6X20mm) 	(16) 6 Screws (M6X30mm) 
(17) Wrench 	(18) Hanger 		

## Notice

- Do not stand in this chair or use the chair as a step ladder, use it as chair only.
- This chair is designed for one person to use at a time, weighting up to 300lbs (136kg).
- Do not use this chair unless all bolts, screws and knobs are firmly secured.
- Check all bolts, screws and knobs every 90 days. Tighten them if any are loose.
- Failure to follow these instructions may result in serious injury or death of yourself and people around you.
- Some of the parts are heavy and/or have sharp edge, please install it carefully to avoid hurting you and people around you.

## Instructions for Use



**Up and Down Adjustment**

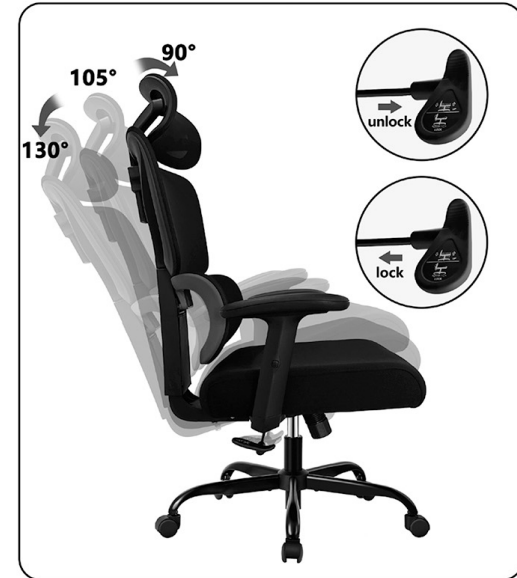

**Tilt Function**



**Armrest Height Adjustment**



**Weight Capacity 300 lbs (136kg)**

Thanks for purchasing our products. Please read this manual before assembly, and please assemble in order. After the assembly, keep the instruction properly. Make sure all the parts are included (18 kinds in total).

# Assembly Instruction

Please assemble in a wide and flat place.

## Step 1

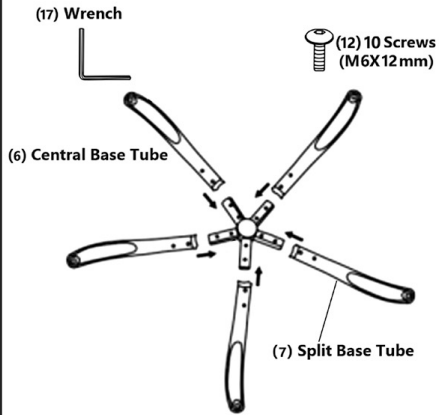

Take out Split Base Tube (7) and Central Base Tube (6). Insert Split Base Tube (7) into Central Base Tube (6) as shown. You can see the Split Base Tube (7) and Central Base Tube (6) each has a screw hole, align them and tighten 10 Screws M6×12mm (12) with Wrench (17) to fix 5 Split Base Tube (7) to Central Base Tube (6).

## Step 2

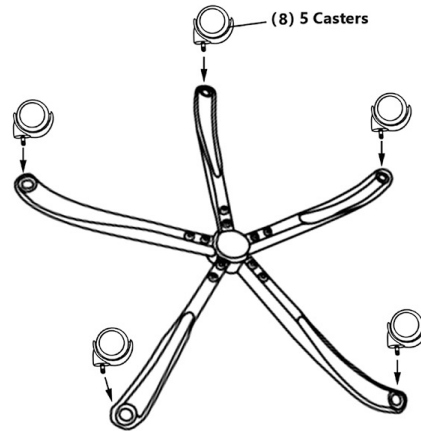

Take out 5 Castors (8), firmly insert them vertically into the hole of the Split Base Tube (7) as shown.

## Step 5

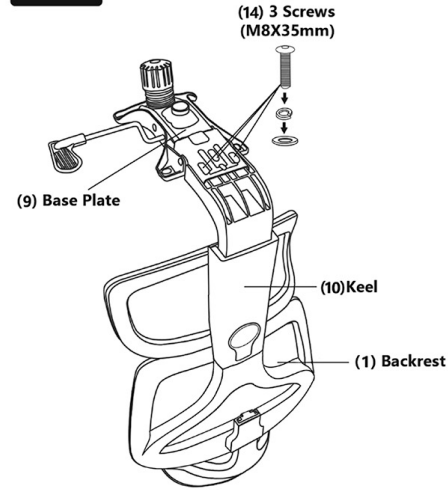

After Step 4, take out the Base Plate (9), and connect it to the Keel (10) with 3 Screws M8×35mm (14) together as shown in the picture.

## Step 6

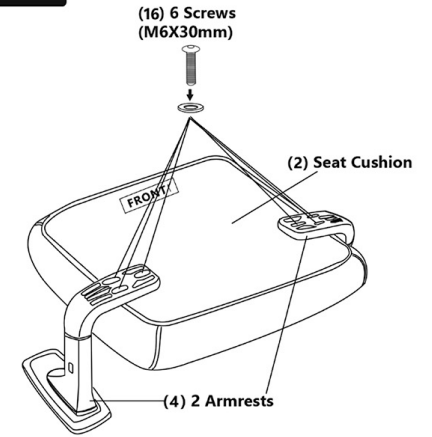

Then fix the bottom of Armrests (4) to the back of Seat Cushion (2). Tighten the 6 Screws M6×30mm (16) with Wrench (17) firmly.

\* Caution: The RIGHT Armrest is engraved with a R Logo, and the LEFT side is L. Please install them correctly.

## Step 3

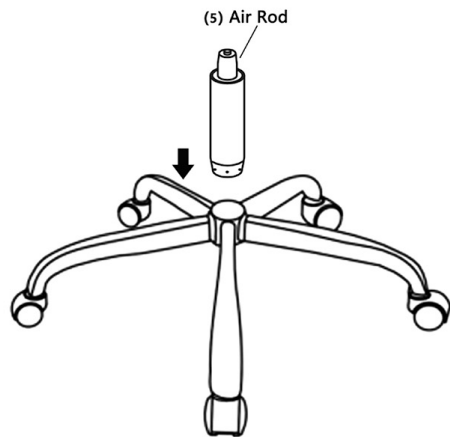

Take out Air Rod (5), insert it into the hole of Central Base Tube (6) as shown. Put it aside and we will use it in Step 8.

## Step 4

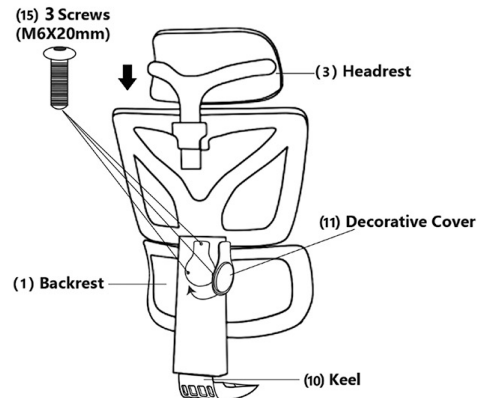

Next, take the Headrest (3), align and insert into the Backrest (1). Then assemble the Backrest (1) and Keel (10) with 3 Screws M6×20mm (15), then cover the Screws with Decorative Cover (11).

## Step 7

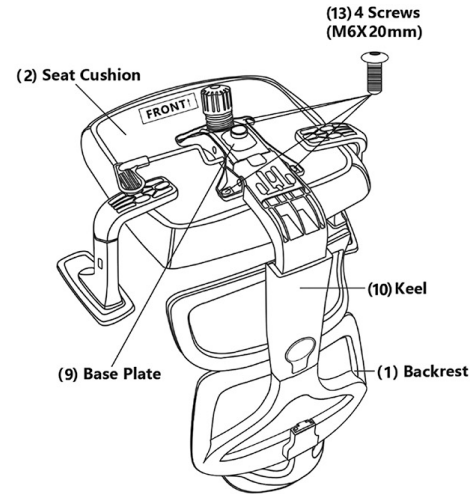

After Step 6, connect the Seat Cushion (2) to the Base Plate (9) with 4 Screws M6×20mm (13).

## Step 8

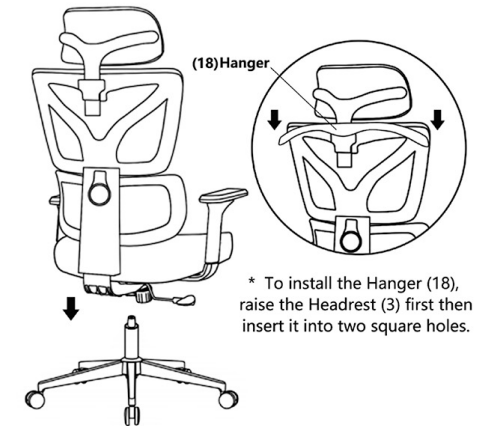

\* To install the Hanger (18), raise the Headrest (3) first then insert it into two square holes.

Finally, take a closer look at the holes in the Base Plate (9), lift firmly the upper part of the chair that you just assembled. And align the holes in the Base Plate (9) with the Air Rod (5) assembled in Step 3.