

WARRANTY

We strive to offer high-quality product and we also try our best to satisfy each customer that orders from us with product or service as needed.

Each customer a record of their order such as the order number, or item receipt for any items that are out of the warranty period you may also still receive replacement parts by purchasing them with our company if they are available.

**Are you having difficulty
with assembly? Missing parts?**

**Please contact us : info@firstopintl.com
telephone No.:5627813327**

send an email with your order No. to us

**For return, please check the return policy with
the retailer or market place you bought from.**

Appreciate your purchasing from us.

Pop up your life by our furniture !

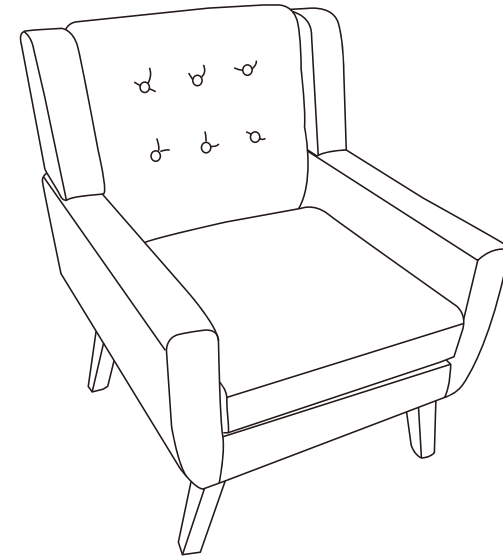
The logo for Wixe, featuring the word "wixe" in a bold, lowercase, sans-serif font. The letter "i" is stylized with a grey dot and a grey shadow to its right.

ITEM NO. SF0003

NOTE:

This brochure contains IMPORTANT safety info. Please read and keep for future reference.

MAINTAINANCE AND WARNING

- Keep furniture away from heat and fire.
- Keep furniture away from sharp objects.
- Do not clean furniture with harsh cleansers or polish. Do not use detergents, Solvents, abrasives, spray packs or leather cleaner. Use non-color mild soap with warm water clean spills(Mix 1:10 soap to water)
- Do not place furniture under direct sunlight, material will possibly fade over time.
- Do not jump or strike on the furniture.
- Do not write on furniture without a padded barrier to protect the surface.
- Not for commercial use, For residential use only.



Weight Limitation

400LBS

PARTS LIST

Ax1

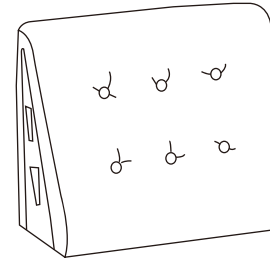

Back

Bx1

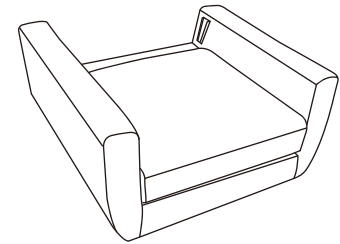

Seat Frame

Cx1



Right Wing
(packed in bottom of part B)

Dx1

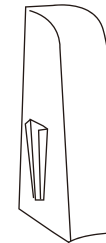

Left Wing
(packed in bottom of part B)

HARDWARE and TOOL LIST

Ex4

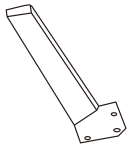

Legs

Gx1



Allen Key

Fx12

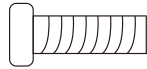

Bolt

M8X20

Be sure to check all packing material fitting the packing list. Be careful for small parts, which may have come loose inside the carton during shipment.

ASSEMBLY INSTRUCTIONS

Step 1

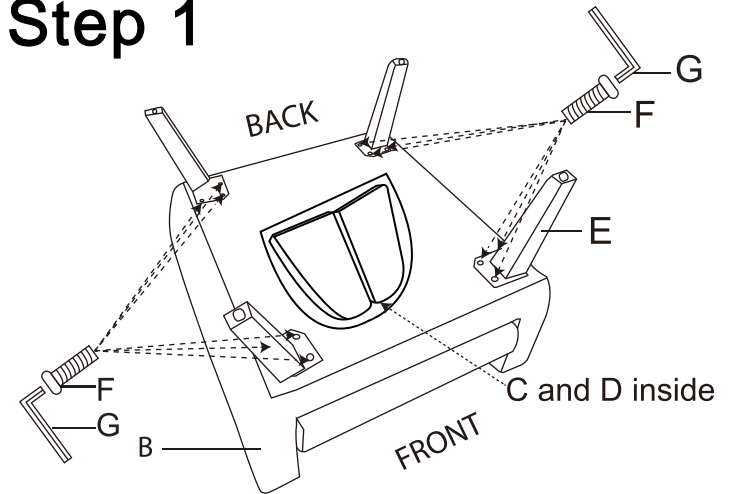

Each screw is rotated to 30% first, and the three screws on each foot are screwed in, and then completely tightened with the allen key.

Turn the seat frame B upside down on clean padded surface, Use bolt F, allen key G to attach the legs E on rear bottom of the armrest fasten all boltes to secure.

Step 2

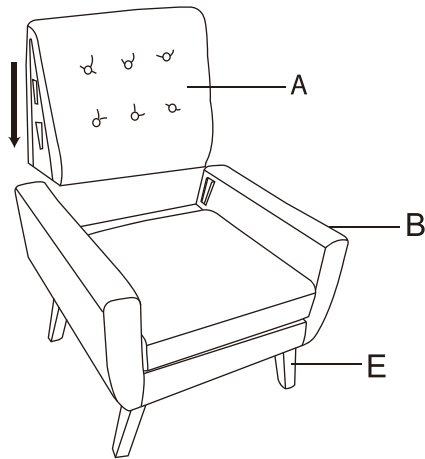

Operate carefully to prevent damage to fabric
fabric when metal connectors are inserted.

Turn the chair base assembly upright, carefully
align male and female metal brackets on both
sides then push the back A all the way down to
secure.

Step 3

Squeeze firmly horizontally towards the
backrest, align the metal connector, and
then press firmly down until it is fully
secured.

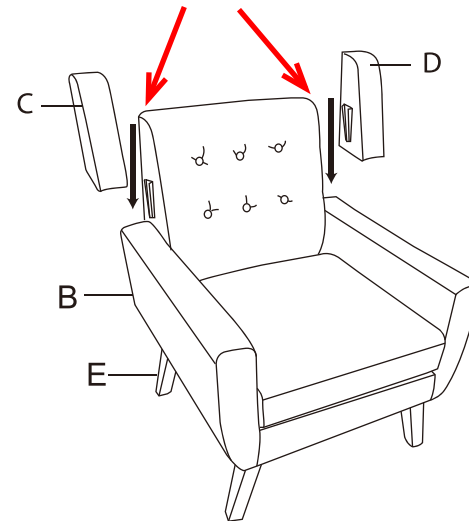

Take the left wing D and right wing C out of the
bottom of the seat, and carefully align the metal
brackets on either side of the back to ensure
full bite.

Step 4

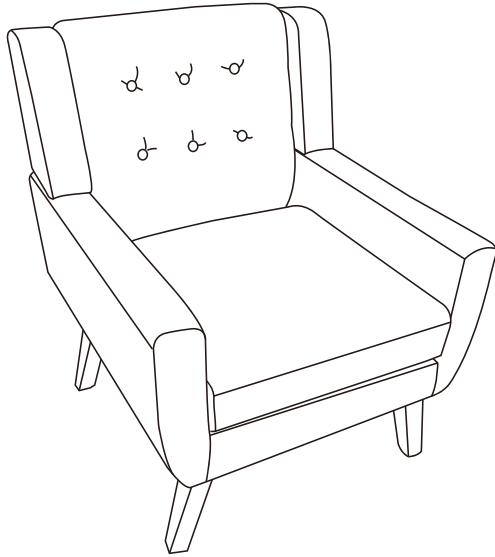

Tidy up the sofa to make it beautiful, adjust the screws on the sofa foot, make the sofa stable, and the assembly is completed.