

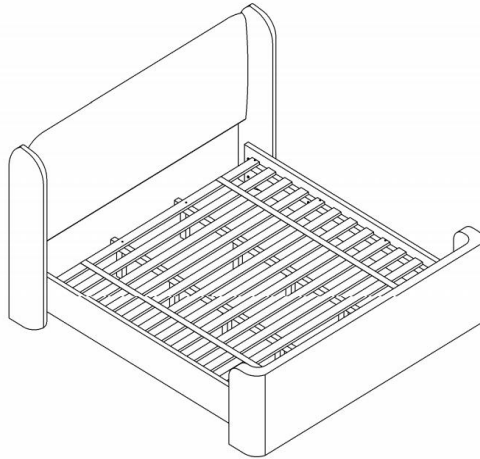

Darker Living[®]
sleep

Assembly Instructions Shiloh White Mocha



BEFORE ASSEMBLY

Thank you for purchasing this quality product. This product has been designed for easy assembly and constructed for durability. Please take the time to read and follow the assembly instructions carefully.

Part List

When unpacking, please be careful not to discard any parts with the packaging. Before continuing, please make sure you have the following parts:

Carton 1

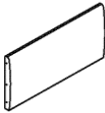
NO.	DES.		QTY
A	Headboard		1

NO.	DES.		QTY
B	Headboard wings		2

Carton 2

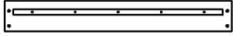
NO.	DES.		QTY
C	Side rails		2



NO.	DES.		QTY
D	1PC Center Slat Support		2

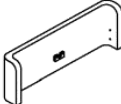

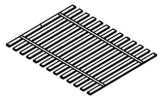
Carton 3

NO.	DES.		QTY
E	Footboard		1

NO.	DES.		QTY
F	13PCS slat		1

Hardware (in carton 3 box)



NO.	DES.		QTY
G	Center Support leg		8
H-1	Bolts		8*55mm 6
H-2	Washer		5/16(8)*22*1.5mm (silver) 14

NO.	DES.		QTY
H-3	Bolts		8*70mm 8
H-4	Wrench		5*43*67mm 1
H-5	Screws Note: Phillips screwdriver not included		40mm 12

Step 1

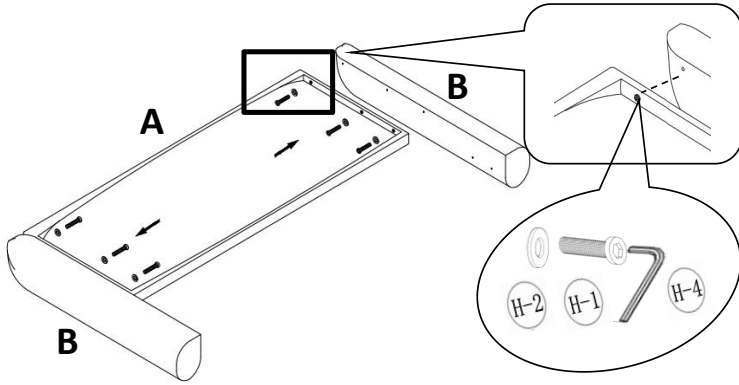
1. Attach wings to the headboard by bolts.





H-1 × 6	Bolts		8*55mm
H-2 × 6	Washer		5/16(8)*22*1.5mm
H-4 × 1	Wrench		5*43*67mm

Step 2

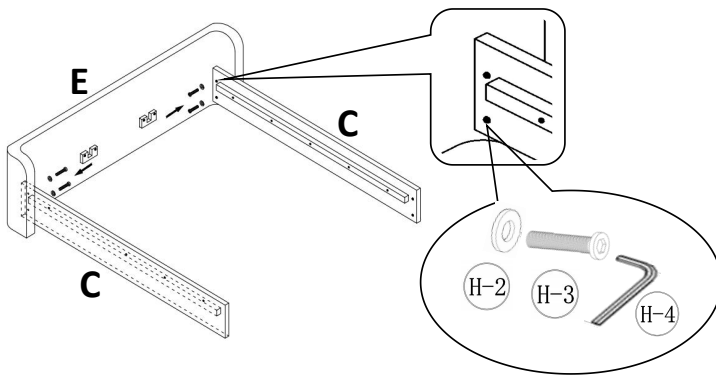
Use washers (H-2) & bolts (H-3), attach side rails (C) and footboard (E) with wrench provided (H-4). Screw and secure bolts tightly.





H-3 × 4	Bolts		8*70mm
H-2 × 4	Washer		5/16(8)*22*1.5mm
H-4 × 1	Wrench		5*43*67mm

Step 3

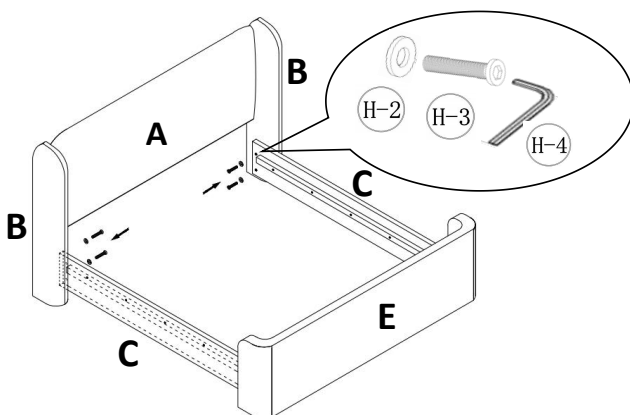
Use washers (H-2) with bolts (H-3), attach headboard (A) and side rails (C), same to attach side rails and footboard (E) with wrench provided (H-4). Screw and secure bolts tightly.



H-3 × 4	Bolts		8*70mm
H-2 × 4	Washer		5/16(8)*22*1.5mm
H-4 × 1	Wrench		5*43*67mm

Step 4

Twist and screw middle support feet (G) into the predrilled holes on center slat support (D).

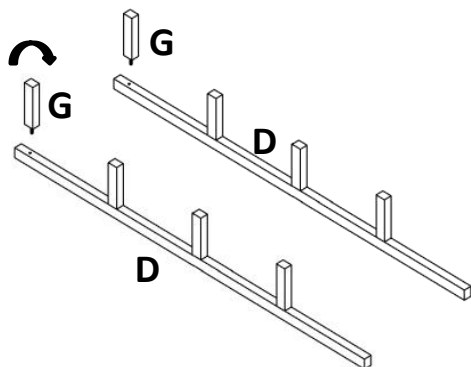

Step 5

Slide both ends of center slat support into the U shape connector circled in diagram.

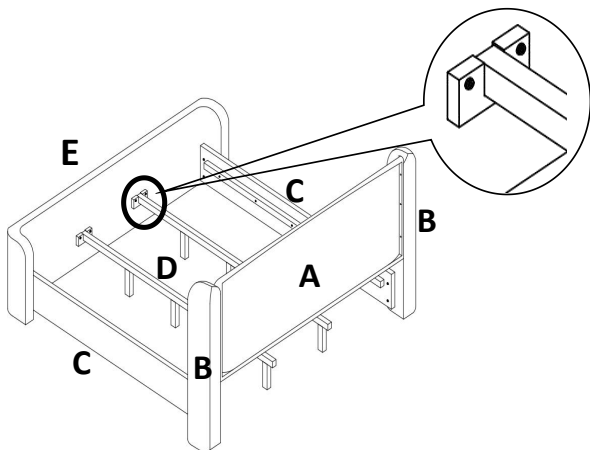

Step 6

Open the rolled slats (F) and place on top of the slat support. Secure the slats using the screws (H-5). And then the assembly is done.

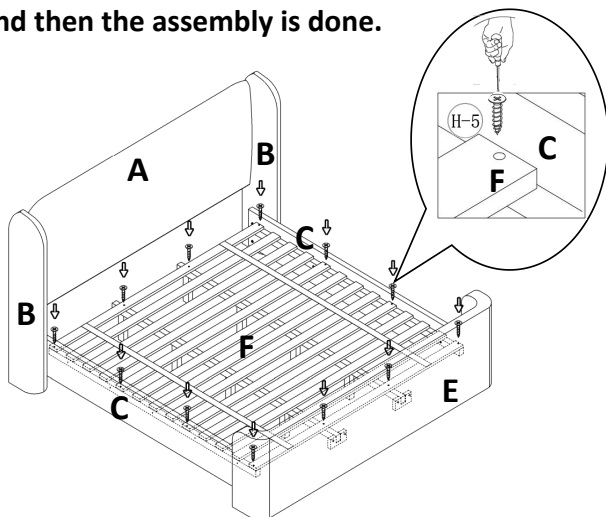

Phillips screwdriver not included.

H-5 × 12	Screws		40mm
----------	--------	---	------